



4K HDMI HDBaseT™ Extender Set, 100m



Manual

DS-55504 Rev. 2

Please read below safety instructions carefully before installation and operation:

1. Please pay attention to all the warnings and hints on this device.
2. Do not expose this unit to rain, moisture and liquid.
3. Do not put any stuff into the device.
4. Do not repair or open this device without professional instructions
5. Shut off power and make sure environment is safe before installation.
6. Do not plug-in/out the connected cables when it is in using.
7. Make sure the specification matched if using 3rd party DC adapters.

Introduction

This HDBaseT™ single network cable extender transmits HDMI signal up to 100 meters over Cat 6 network cable fluently and clearly. It is lossless in signal and supports 3D, 24bits Deep Color, CEC, HDCP and 4K2K/60Hz resolution. It's a perfect solution for audio and video transmission in applications of HD conference system, HD multimedia education system, HD digital advertising and signage etc.

Features

1. Support bi-directional IR pass back.
2. Uncompressed HDMI video signal.
3. Supported resolution is up to ultra HD 4Kx2K@60Hz.
4. Support bi-directional RS232 passback.
5. Support HDBaseT™, HDCP2.2, CEC, 24 Deep Color.
6. Support LPCM, DTS-HD and Dolby True HD audio.
7. Transmit 4K2K/60Hz signal over Cat 6 up to 100 meters.

Package Contents



TX Sender x1pcs



RX Receiver x1pcs

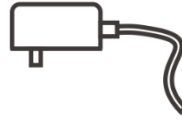

DC12V/1A x2pcs



User manual
x1pcs

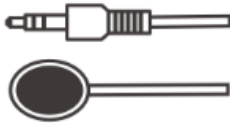

IR blaster extension
cap x2pcs

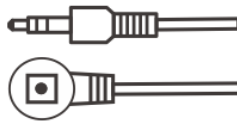

IR receiver extension
cable x1pcs



RS232 serial port
cable x1pcs

Installation Requirements

1. HDMI source devices: with HDMI OUTPUT interface
2. Display devices: With HDMI INPUT port
3. Network cables: Cat 6/Cat 6A/Cat 7 network cables



Panel Description

1. TX Sender

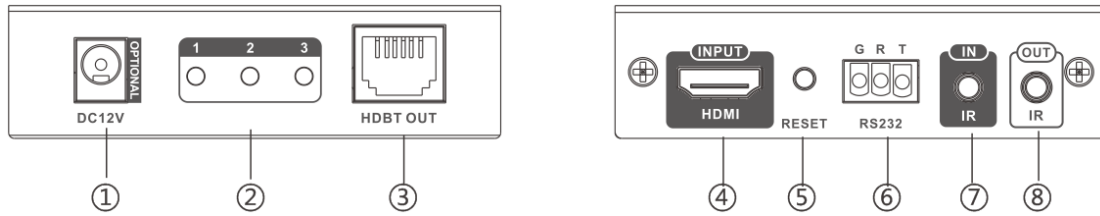

①	Power input	Connect with DC12V/1A power adapter
②	Transmission signal indicator	<p>1. LED 1: It turns on when power on.</p> <p>2. LED 2: It turns on when the transmitter unit and the receiver unit connect well with each other, and it flashes when there is no transmission between the transmitter unit and the receiver unit.</p> <p>3. LED 3: It flashes when the receiver unit connected well with the HDMI display device, and it turns off when no transmission between the receiver unit and the display device.</p>
③	HDBT Output	To connect with receiver by network cable
④	HDMI input	Connect with HDMI source device
⑤	Reset button	Press for restarting the unit
⑥	RS232	RS232 control
⑦	IR receiver extension cable interface	Connect with IR receiver extension cable. Please make sure the remote control is within the required range of IR receiver
⑧	IR blaster extension cable interface	Connect with IR blaster extension cable. Please put the IR blaster close to source device to best transmit the IR signal from receiver

2. RX Receiver

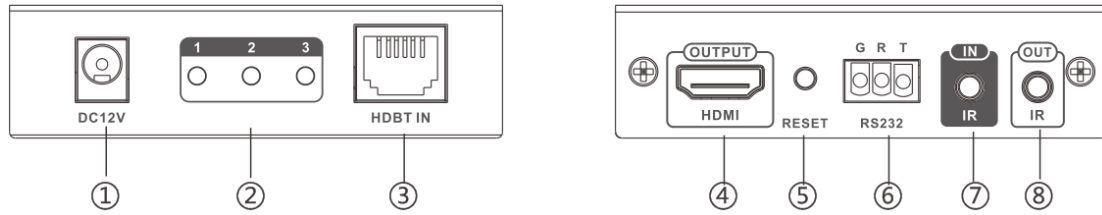

①	Power input	Connect with included DC12V1A power adapter
②	Transmission signal indicator	<ol style="list-style-type: none"> 1. LED 1: It turns on when power on. 2. LED 2: It turns on when the transmitter unit and the receiver unit connect well with each other, and it flashes when there is no transmission between the transmitter unit and the receiver unit. 3. LED 3: It flashes when the receiver unit connected well with the HDMI display device, and it turns off when no transmission between the receiver unit and the display device.
③	HDBT input	To connect to transmitter by network cable
④	HDMI output	Connect with HDMI display device
⑤	Reset button	Press for restarting the unit
⑥	RS232	RS232 control
⑦	IR receiver extension cable interface	Connect with IR receiver extension cable. Please make sure the remote control is within the required range of IR receiver
⑧	IR blaster extension cable interface	Connect with IR blaster extension cable. Please put the IR blaster close to source device to best transmit the IR signal from receiver

Installation

1. Connections

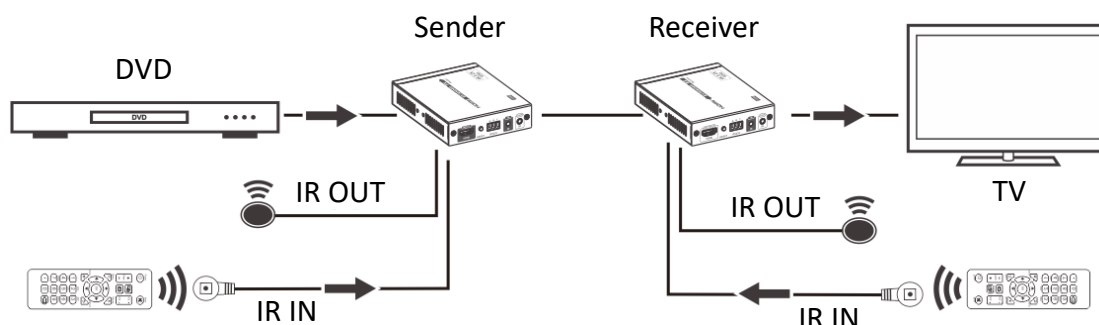

2. Bi-directional IR pass back

- 1) It supports bi-directional IR pass back. User can control DVD at RX end and control TV at TX end.
- 2) If control at RX end, please connect IR blaster extension cable with IR OUT of TX and connect IR receiver extension cable with IR IN of RX. If control at TX end, please connect IR receiver extension cable with IR IN of TX and connect IR blaster extension cable with IR OUT of RX.

3. RS232 serial bi-direction passback function

1) Baud rate

Different encoding mechanism cannot mix-connect, the baud rate of RS232 serial of these transmitter unit and receiver unit, support 4800, 9600, 19200, 28800, 38400, 57600, and 115200

2) Line order

Check and make sure the RS232 serial line connect firmly and well, and make sure serial data line is connected correctly as below:
If the RS232 serial does not work by following above connection, please try to change the order of TXD line and RXD line.

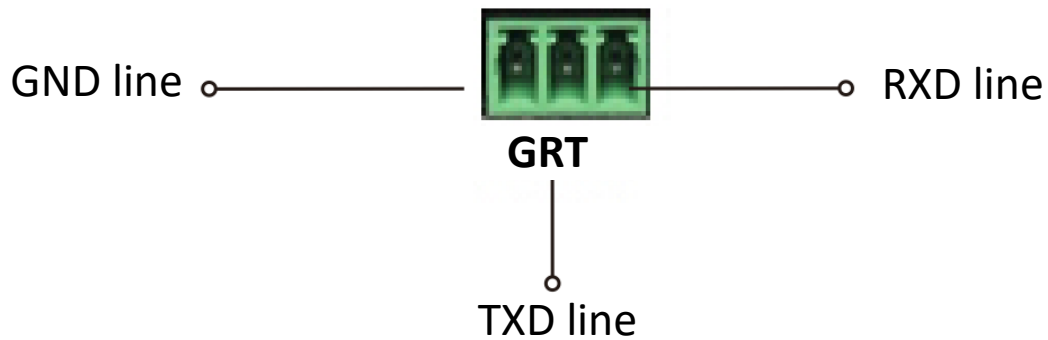

3) Check baud rate

If need to check the baud rate at last time, firstly, set the baud rate to 115200 on your serial port test tool before power on. Then power on, when the RS232 serial of product connects to serial port test tool, the software will read out the baud rate at once. e.g.: software show information "Baud rate: 9600", means 9600 is the current baud rate.

4) Set baud rate

For example: the current baud rate is 9600, but the baud rate of control equipment is 19200, so the baud rate should be set as 9600. At this time, in serial port tool, choose baud rate "9600", then input command "set: 19200" in character format and send it out.

FAQ

Q: No output on screen?

- A:
- 1) Firstly, please check and make sure the power supply is connected well. Then, check and make sure all cables are connected correctly.
 - 2) Please check and make sure the right HDMI input port of the TV/screen has been chosen.
 - 3) Please check and make sure there is HDMI signal to be fed into transmitter unit, and check and make sure the receiver unit has been connected well with the display device.

Q: Indicator LED 2 keeps off and no output?

A: Check and make sure the HDMI display device has been switched to the right HDMI input channel.

Q: Indicator LED 3 keeps off?

A: Check whether the TX's HDMI IN has signal input and make sure RX's OUT is well connected with HDMI display.

Q: Output image with snow point?

A: Change the HDMI cable between the transmitter unit and the source device; it will be better to use a shorter HDMI cable for re-testing.

Specification

Items	Specifications		
HDMI signal	Support HDMI2.0 HDCP2.2, support CEC and 24bits deep color		
Resolution Supported	480i/480P/576i/576P/720P/1080i/1080P/3D/4Kx2K		
Audio	LPCM, DTS Digital, Dolby Digital		
Network cable	CAT6, CAT6A, CAT7		
Transmission length	CAT6	70m	1080p@60Hz 48bpp, 1080p@60Hz 3D, 4Kx2K@60Hz
	CAT6A	70m	
	CAT7	70m	
IR control	Support 20~60kHz wide frequency devices and Bi-directional IR transmission		
Working temperature	0~55°C		
Storage temperature	-10~70°C		
Humidity	0~90% (no condensation)		
Power supply	DC 12V/1A x2pcs		
Power consumption	TX: <6W; RX: <8W		
Product dimension	109.49(L)x87.0(W)x23.4(H)mm		
Material	Iron alloy material		
Weight	TX: 240g RX: 250g		
Color	Black		

This is a Class A product. In home environment, this product may cause radio interference. In this case, the user may be required to take appropriate measures.

Hereby Assmann Electronic GmbH, declares that the Declaration of Conformity is part of the shipping content. If the Declaration of Conformity is missing, you can request it by post under the below mentioned manufacturer address.

www.assmann.com

Assmann Electronic GmbH

Auf dem Schüffel 3

58513 Lüdenscheid

Germany

