

FEATURES	
Technology	POMS (Per Outlet Metering & Switching)
Energy Metering	Voltage(V), Current(A), Active Power(W), Apparent Power (VA), Reactive Power (var), PF, Frequency(Hz), kWh
Metering per Input Line	Yes (Branch Circuit and Total Current) Accuracy 1%
Metering per Output Receptacle	Yes
Remote Outlet Switching	Yes
Ethernet Port	2 Gigabit Ethernet ports to acces the PDU from 2 different networks
Networking Protocols	DHCP, IPv4 and IPv6, DNS, http / https, SSHv.2, SNMP v1 / v2c / v3, SNMP TRAPS / SETS / GETS, SMTP, Modbus , TCP, RADIUS, Syslog, TLS 1.3, SNTP, ARP, ICMP, ICMPv6, UDP, NDP
PDU Cascading	16 PDUs
Power Share	Yes
Network Controller	Replaceable Hot Swapable controller with 4 button OLED display
Residual Current Monitoring	No
Rack Acces Control	Compatible with DCIM solutions
USB Ports	2 USB A ports WiFi networking,webcam,PDU configuration and mobile interface
Environmental Sensors	All in one Temperature and Humidity sensor with 2 digital inputs (for connect air flow, door sensor, water leak, smoke detector and Vibration sensor) plug and play bus allows to connect 8 EMD devices in one PDU
INPUT	
Plug	IEC60309 3P+N+E 6h 32A 380-415V
Lead Length	3 meter
Cable Type	H07RN-F5G4.0 mm <sup>2</sup>
Max. Input Load	32A
Rated Input Voltage	380-415V three phase
Frequency	50-60Hz
Power Capacity	22.1kW
OUTPUT	
Rated Output Voltage	190-250V Single phase
Output Types	36 IEX (C13/C19) combo with LED (Max rate 16A) EN61984+UL498 certified
Overload Protection	(6) 1 Pole Carling 16A J Series J51-BO-24-616-M1D-D3
CHASSIS	
Dimensions (W x D x H)	1832 x 60 x 72 mm
Color	RAL 9004 black powder coat
Mounting Options	4 mounting options (see page 2)
Required Torque for Mounting Screws	≥2.54N·m (25.9kgf·cm or 22.4 in·lbs)
OPERATING ENVIRONMENT	
Temperature Range	0° to 60° C (30° to 140° F)
Humidity	0 - 95 %
Elevation	0 - 4000 Meters
CONFORMANCE	
IEC 62368-1 (Third Edition)	

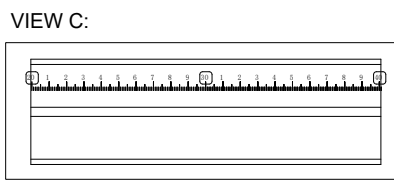

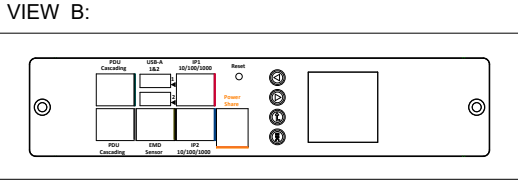
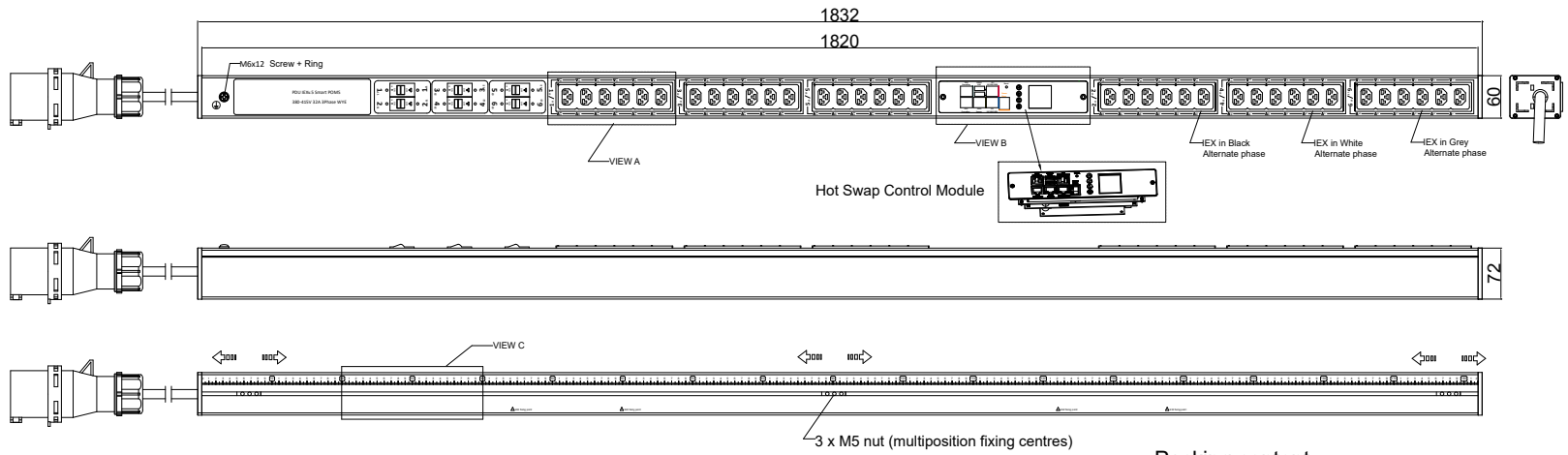
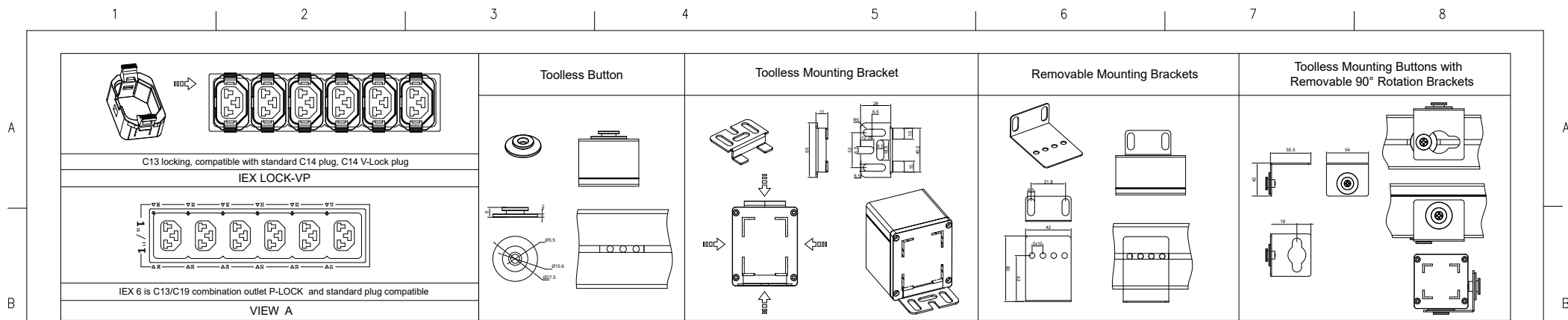

Chassis Color	Code
Black	Standard color
White	W
Red	R
Blue	A
Green	G
Orange	O
Grey	GY
Yellow	Y

Packing content:

IEX Lock-VP  X36 (black,white,grey)

<b>POMS Series</b> Inlet Power Monitoring Per Outlet Monitoring & Switching Environmental Monitoring	<b>OUTPUT</b> (12) IEX (C13/C19) combo with LED Black (Max rate 16A) (12) IEX (C13/C19) combo with LED White (Max rate 16A) (12) IEX (C13/C19) combo with LED Grey (Max rate 16A)	<b>OPERATING TEMPERATURE</b> 0° to 60°C	<b>Revisions</b>						
			<b>INPUT</b> 380-415VAC 32A 50HZ IEC60309 32A 3P+N+E Plug 3m H07RN-F5G4mm <sup>2</sup> Power Lead	<b>BRANCH CIRCUITS</b> (6) 1 Pole Carling 16A J Series J51-BO-24-616-M1D-D3	<b>MOUNTING ACCESSORIES</b> (2) Toolless Button (2) Toolless Mounting Bracket (2) Removable Mounting Brackets (2) Toolless Mounting Buttons with Removable 90° Rotation Brackets	<table border="1"> <thead> <tr> <th>Rev</th> <th>Description</th> <th>Date</th> </tr> </thead> <tbody> <tr> <td> </td> <td> </td> <td> </td> </tr> </tbody> </table>	Rev	Description	Date
Rev	Description	Date							

DRAWING TYPE  (NO PERMISSION, NO CHANGING)	<b>DN-PMS-36IEX-3F32A-V</b>	
<b>unit=mm</b>  TECHNICAL STANDARD IT11; NO RUST NO FLAW ON THE SURFACE	<b>Housing</b>	Aluminium Black Powder Coating RAL9004
FILLET R0.5 ANGLE ±0.5° FIRST ANGLE 		
DATE 03-01-2022		

- Low cost locking solution at both ends
- Different colors available
- Patented IEX locking system
- Locking sleeve for C13 and C19 plugs
- VDE, UL approved

# IEX PATENTED LOCKING SOCKET - POWER CORD SOLUTION



## C14 - C13 Sleeve

H05VV-F3G1 mm<sup>2</sup>

Color	0,5M	1M	2M
Black	✓	✓	✓
Red	✓	✓	✓
Blue	✓	✓	✓

## C14PLOCK - C13 Sleeve

H05VV-F3G1 mm<sup>2</sup>

Color	0,5M	1M	2M
Black	✓	✓	✓
Red	✓	✓	✓
Blue	✓	✓	✓

## C20PLOCK - C19 Sleeve

H05VV-F3G1,5 mm<sup>2</sup>

Color	1M	2M
Black	✓	✓
Red	✓	✓
Blue	✓	✓

## C20PLOCK - C13 Sleeve

H05VV-F3G1 mm<sup>2</sup>

Color	1M	2M
Black	✓	✓
Red	✓	✓
Blue	✓	✓



QTY	Part No.
1	PD090-3

Part No.  
PP029-3

Part No.  
PP081-6

Part No.  
PP030-4

Part No.  
PP070-5

QTY	Part No.
12	IEXLOCKB
12	IEXLOCKW
12	IEXLOCKG

QTY	Part No.
2	MT190

QTY	Part No.
2	MT124-1

QTY	Part No.
2	PL178

QTY	Part No.
2	MT124-1

QTY	Part No.
2	MT190-2

QTY	Part No.
6	MT124

QTY	Part No.
2	PL178

QTY	Part No.
2	MT190-3

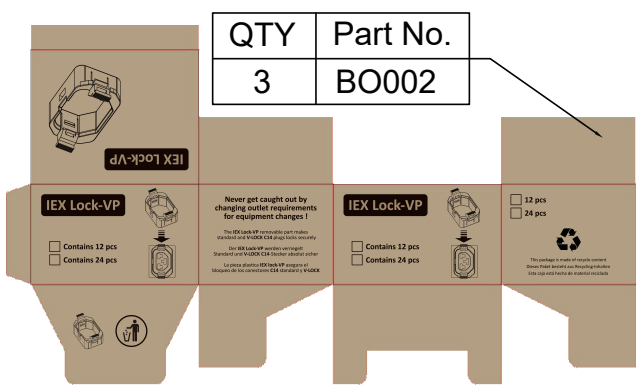

**PK037**  
Section 23.5x9 cm Length 220 cm

**Weight: 10kg(2 PDU)**