



# Smart Power Distribution Unit



**Manual**  
DN-95631

# Content

1. Smart PDU Introduction.....	3
1.1. Function Description .....	3
1.2 Application range.....	5
1.3 Product picture and description.....	6
1.4 Installation .....	7
2. Hardware Introduction.....	7
2.1. System initialization.....	7
2.2. View system information.....	7
2.3.Overload Monitoring .....	111
2.4. Environment monitoring .....	11
2.5. PDU reset.....	11
2.6. Display backlight always-on configuration .....	11
2.7. Reverse the display.....	11
2.8. Restore to factory settings.....	12
2.9. Master or Slave configuration .....	12
2.10. Daisy-Chain .....	12
3. SMART PDU Software Introduction .....	133
3.1.Software overview.....	133
3.2. Access method .....	133
3.2.1 Web access .....	133
3.2.2 SNMP Access.....	377
3.2.3 Telnet Access.....	455
3.2.4. MODBUS Access .....	544
4. Frequently Asked Questions .....	544
4.1. Forget IP address?.....	544
4.2. Fail to send email? .....	544
4.3. Lost IP.....	544
5.Technology Parameters .....	555

## Safety and Grounding:

*Read the following information before installing or operating your DIGITUS Power Distribution Unit:*

- This PDU is intended for indoor use only.
- This PDU must not be must not be operated one behind the other!
- Operation only in dry and closed rooms.
- This PDU may not be operated covered. Always ensure free accessibility.
- The maximum power stated on the rating plate must not be exceeded.
- Plug this PDU into a three-wire, grounded power outlet only. The power outlet must be connected to appropriate branch circuit/ mains protection (fuse or circuit breaker). Connection to any other type of power outlet may result in a shock hazard.
- Use only the supplied brackets of mounting.
- Check that the power cord, plug, and socket are in good condition.
- Voltage free only when the power plug is unplugged.
- Disconnect the PUD from the power outlet before you install or connect equipment to reduce the risk of electric shock when you cannot verify grounding. Reconnect the PDU to the power outlet only after you make all connections.
- Operation under unfavorable environmental conditions must be avoided. (Humidity over 80% relative, wet, ambient temperatures above 50 ° C, solvents, flammable gases, dust, vapors).
- If external damage to this PDU is detected, do not operate this PDU. Take this PDU immediately out of service if external damage is detected.
- Do not pour liquids over the power strip. There is a high risk of fire or life-threatening electric shock.
- When opening the power strip, live parts can be exposed. There is a risk of electric shock. The power strip may only be opened by a specialist. When opening the power strip, live parts can be exposed. There is a risk of electric shock. The power strip may only be opened by a specialist.

## 1. Smart PDU Introduction

The Smart Power Distribution Unit is a network manageable device that provides power monitoring, controlling and managements to many equipments in the rack cabinet of data center all over the world through LAN or WAN. For meeting with the restrictions and requirements in different environment, SMART PDU supplies many connection methods that user can manage it through its Web interface (HTTP or HTTPS), Serial connection, Telnet or SNMP.

### 1.1. Function Description

1. Monitoring function: monitor the current, voltage, power (kW) and energy consumption (kWh), environment status like temperature, humidity, smoke, door and water leakage via IP and local LCD screen.
2. Controlling function: switch on/off individual outlet, set the interval of sequential power on/off
3. Keeping the former state: keep the former state of each outlet after resetting.
4. User-defined alarm: user can set the threshold of current, temperature and humidity.
5. System default alarm: receive warning when the total rating current, individual rating current

(A&C series not included) are exceeded; when smoke, water or door open was detected.

6. Alarm methods: Alarming information will be shown on LCD screen and SMART PDU buzzer beeps. The problem value flashes on web interface and PC buzzer alarms automatically send e-mail to system administrator; SNMP sends Trap alerts.
7. Daisy-chain: suggest daisy-chain at most 5 units (Master unit included)
8. User management: user rights configurable. Added new user can be distributed into different user groups with different rights. User group rights are editable.
9. Access method: Web interface, HTTP, HTTPS, SNMP (v1 / v2c / v3), Telnet and Serial console.
10. Support multi-user operation system and software update.

There are four series enable for Smart PDU range.

A, B, C, D function comparison table:

	A series	B series	C series	D series
Input-level Metering (A/V/VA/kWh/Power factor)	Yes	Yes	Yes	Yes
Individual Outlet Metering	No	Yes	No	Yes
Individual Outlet Switching	No	No	Yes	Yes

A series: DN-95624/ DN-95625

B series: DN-95628/ DN-95629

C series: DN-95630/ DN-95631

D series: DN-95632/ DN-95633/ DN-95634

No.	Function	Description & Range
1	Monitoring	Monitoring function: Through the local LCD screen user can view the total current and the current of each individual outlet (A&C series not included), the on/off status of each individual outlet (A&B series not included), the environment status like temperature/humidity/smoke/water logging and door



2	Controlling	Controlling function (A&B series not included): Switching On/Off each individual outlet, set up the power on/off delay, Return-to-zero for total or individual power consumption, configure the schedule event, power cut-off settings when overload, quick setup of mass PDUs and back-up, and WIFI settings.
3	Keeping the former state	Keeping the former status (A&B series not included) : keep the former state of each outlet after restart
4	User-defined alarm	User-defined alarm: when thresholds of total current, individual current (A&C series not included), temperature and humidity are exceeded
5	System default alarm	System default alarm: when the total rating current, individual rating current (A&C series not included) are exceeded; when smoke, water or door open was detected

## 1.2 Application range

1. SMART PDU can be applied to server rack, network cabinet and etc.
2. Outlet type and number (8, 16, and 24) can be selected according to the actual needs.
3. Meets RoHS directive, applicable for 110~220VAC, 380VAC power supply, can meet customers' requirements all over the world.

### 1.3 Product picture and description

#### 1.3.1 Vertical SMART PDU (0U)

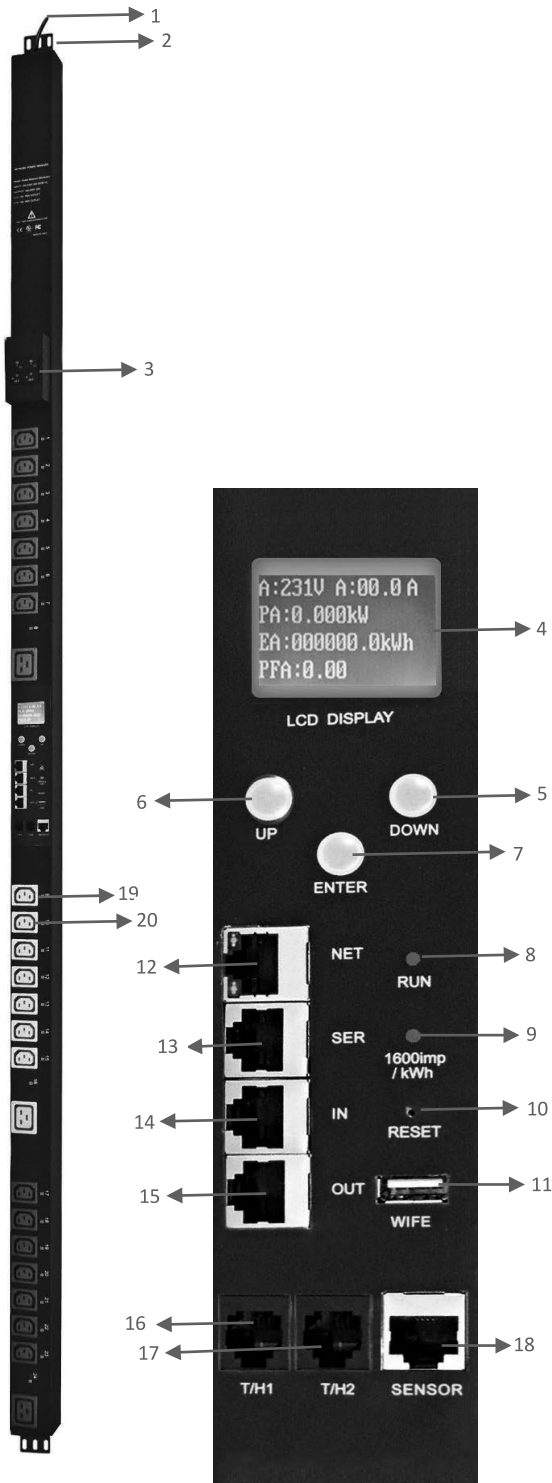

1. Input power cord;
2. Brackets;
3. Hydraulic circuit breaker;
4. LCD screen;
5. DOWN key: scroll down to the next page;
6. UP key: scroll up to the previous page;
7. ENTER: OK button;
8. RUN indicator
9. 1600imp/kWh Energy pulse indicator;
10. RESET button;
11. USB port for WIFI access or software upgrade;
12. NET: 10/100M Ethernet communication port
13. SER: Serial communication port (support MODBUS);
14. IN: for daisy-chain
15. OUT: for daisy-chain
16. T/H1: temperature and humidity sensor port 1
17. T/H1: temperature and humidity sensor port 2
18. SENSOR: extend sensor hub communication port, sensor hub support 2 temperature/humidity sensor, 2 door sensor, 1 water logging sensor and 1 smoke sensor
19. LED indicator;
20. Outlets

## 1.4 Installation

Vertical-mounting (0U)

## 2. Hardware Introduction

### 2.1. System initialization

The buzzer sounds when the SMART PDU is switched on and it stops after 3 seconds.

Then the LCD screen is lighted after 6 seconds with the following information displayed:

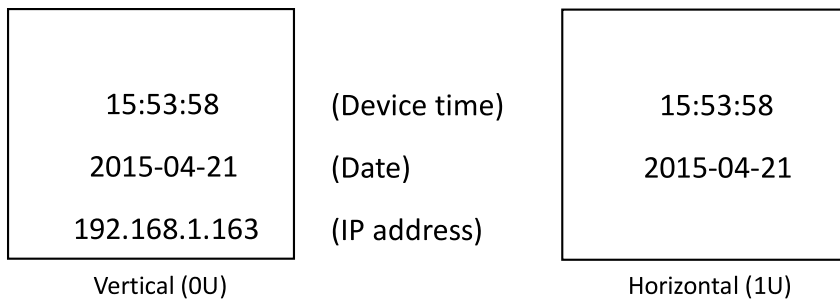

**Note: 192.168.1.163 is the default IP address; and this is the first page after system initialization.**

### 2.2. View system information

#### 2.2.1. View system information (0U)

Press **ENTER** to go to the main menu

(The first page on menu)

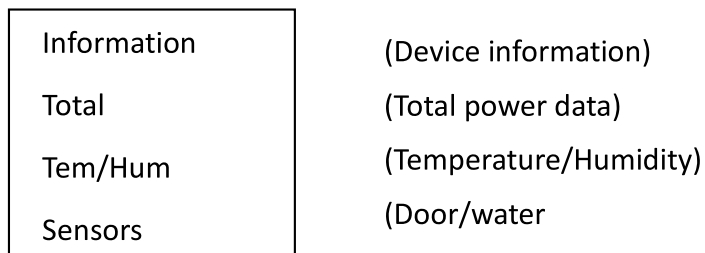

(The second page on menu)

Output	(Outlet socket)
Group	(Outlet group)

Through the DOWN or UP key to scroll down or up to the next/previous page, turn to the main menu and select the first item **Information**, then press **ENTER** to go to the Information menu and the displayed information are as below:

CPU: ARM926EJ-S	(CPU model)
Version: 1.0.0	(Software version)
M/S: Master	(Master/Slave unit)
Type: 3 phase D	(Device series)

**Note: the displayed information may differ from device part number.**

CPU: ARM926EJ-S means the type of the device CPU chip; Version: 1.0.0 is the software version number; M/S: Master means the Master Unit and Slave 1 means the Slave unit 1(1-4 means the order of Slave unit); Type: 3 phase C means the device is 3 phase C series one.

Through the DOWN or UP key to scroll down or up to the next/previous page, turn to the main menu and select the second item **Total**, then press ENTER to go to the Total menu and the displayed information are as below:

U: 214V I: 00.0A
P: 0.000kW
E: 000013.1kWh
PF: 0.00

Note: the above information is from a single phase device, if it is a 3 phase one, the power date of each phase will be displayed as well. U: 214V means the input voltage, I:00.0A means the total input current, P:0.000KW means the total power, E:000013.1kWh means the total power consumption, PF:0.00 means the power factor

Press **ENTER** to return to the main menu, and then press **DOWN** key to select **Temp/Hum** to view the temperature/humidity as below:

T1: ---	H1: ---
T2: ---	H2: ---
T3: ---	H3: ---
T4: ---	H4: ---

Press **ENTER** to return to the main menu, and then press **DOWN** key to select **Sensors** to view the door, water logging, and smoke sensor status as below:

Door1: None
Door2: None
Smoke: None
Water: None

Press **ENTER** to return to the main menu, then press **DOWN** key to select **Output** to view each individual outlet current as below:

Output01: 00.0A
Output02: 00.0A
Output03: 00.0A
Output04: 00.0A

Press **DOWN** or **UP** key to view the current of rest outputs:

**Note: Press UP button to view the previous page of device information.**

Press **ENTER** to return to the main menu, then press **DOWN** key to select **Group** to view each group outlet current as below:

Group1:00.0A	Group5:00.0A
Group2:00.0A	Group6:00.0A
Group3:00.0A	
Group4:00.0A	

### 2.2.2. View system information (1U)

Through the DOWN or UP key to scroll down or up to the next/previous page, turn to the main menu and select the first item Information, then press **ENTER** to go to the Information menu and the displayed information are as below:

Type: SMART PDU (D)	(Device series)
192.168.1.163	(IP address)
Version: 1.0.0	(Software version)
M/S: Master	(Master/Slave unit)

**Note: the displayed information may differ from device part number.**

Type: SMART PDU (D) means the device is Desires; 192.168.1.163 is the IP address, Version: 1.0.0 is the software version number; M/S: Master means the Master Unit and Slave 1 means the Slave unit 1(1-4 means the order of Slave unit);

Through the DOWN or UP key to scroll down or up to the next/previous page, turn to the main menu and select the second item **Total**, then press DOWM to go to the Total menu and the displayed information are as below:

U: 214V I: 00.0A
P: 0.000kW
E: 000013.1kWh
PF: 0.00

**Note: the above information is from a single phase device, if it is a 3 phase one, the power date of each phase will be displayed as well.**

U: 214V means the input voltage, I: 00.0A means the total input current, P: 0.000KW means the total power, E: 000013.1kWh means the total power consumption, PF: 0.00 means the power factor Press **DOWN** key to select **Temp/Hum** to view the temperature/humidity as below:

T1: ---	H1: ---
T2: ---	H2: ---
T3: ---	H3: ---
T4: ---	H4: ---

Press **DOWN** key to select **Output** to view each individual outlet current as below:

Output1:00.0A	Output5:00.0A
Output2:00.0A	Output6:00.0A
Output3:00.0A	Output7:00.0A
Output4:00.0A	Output8:00.0A

**Note:** Press **UP** button to view the previous page of device information.

### 2.3. Overload Monitoring

2.3.1. When the current of individual outlet exceed the user-defined value, the SMART PDU buzzer sounds; LCD screen will light up and switch automatically to the alarming page and current value flash

2.3.2. When the total current exceed the user-defined value, the SMART PDU buzzer sounds; LCD screen will light up and switch automatically to the alarming page and current value flash

### 2.4. Environment monitoring

When threshold of temperature or humidity is exceeded, the SMART PDU buzzer sounds, LCD screen light up and switch automatically to the alarming page. The current temperature or humidity value flashes.

### 2.5. PDU reset

Press and hold the UP key for 6 second to Reset

**Note:** The configuration of the power on/off delay was required again after reset.

### 2.6. Display backlight always-on configuration

Press and hold the DOWN key around 2 seconds, the buzzer sounds and the display screen always light on, Press and hold the DOWN key for another 2 seconds, the display screen will back to normal mode

### 2.7. Reverse the display

Press UP button twice quickly to reverse the text displayed. (Horizontal no rollover function.)

## 2.8. Restore to factory settings

Press and hold the Reset button for 6 seconds and release it till the beep buzzer to restore to factory settings.

## 2.9. Master or Slave configuration

To configure the SMART PDU to be the Master or Slave in the Web interface. The current Master or Slave status will be displayed in the LCD home page, "M/S: Master" means Master, and "M/S: Slave1" means Slave 1

## 2.10. Daisy-Chain

Daisy-chain schema is as following:

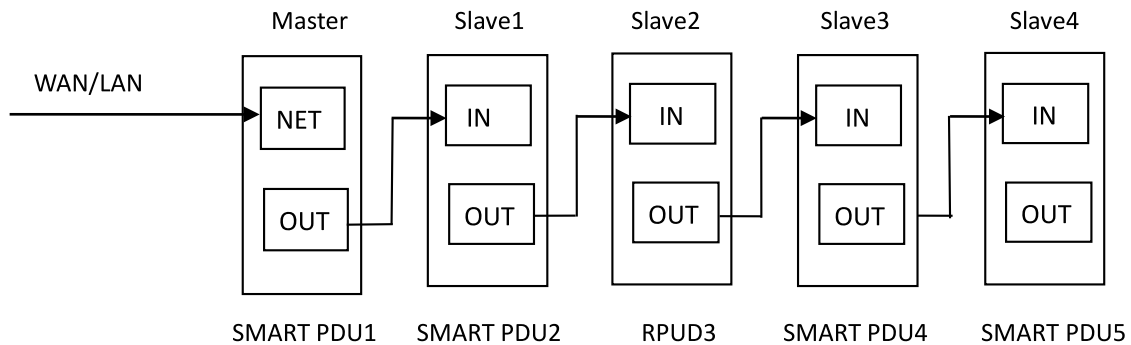

How to daisy-chain

2.10.1. Log on to each SMART PDU; configure the **work mode** on *Device Manage* page.

2.10.2. Daisy-chain all devices like above drawing, from OUT to IN, Maximum 5 units including Master.

2.10.3. Access the Master and check all the status of Slaves. If all readable, daisy-chain is successful.

Remark:

1. Once system runs normal, about 10s later LCD screen display normal.
2. Device sequential power on, power off interval time about 30s. Do not power on/off device frequently to avoid device damage.



## 3. SMART PDU Software Introduction

### 3.1. Software overview

SMART PDU is equipped with embedded software system which provides a lot of network services like WEB server, SNMP, Telnet, SMTP and NTP. It's easy to do second development and software integration.

### 3.2. Access method

Web based, can access via browsers like Internet Explorer, Google Chrome and Fire fox; supports WIFI (including the mobile device like smart phone and tablet), SNMP (v1 / v2c / v3), Telnet and Serial console like MODBUS.

#### 3.2.1 Web access

Open a browser and enter the default IP address, the login window will pop up like below, see figure1-1.



welcome to RPDU system

Name  
admin

Password  
.....

Login

Figure 1-1

Fill in the correct user name and password (**Factory default login name is admin, password is admin**) to login the main interface, see figure1-2

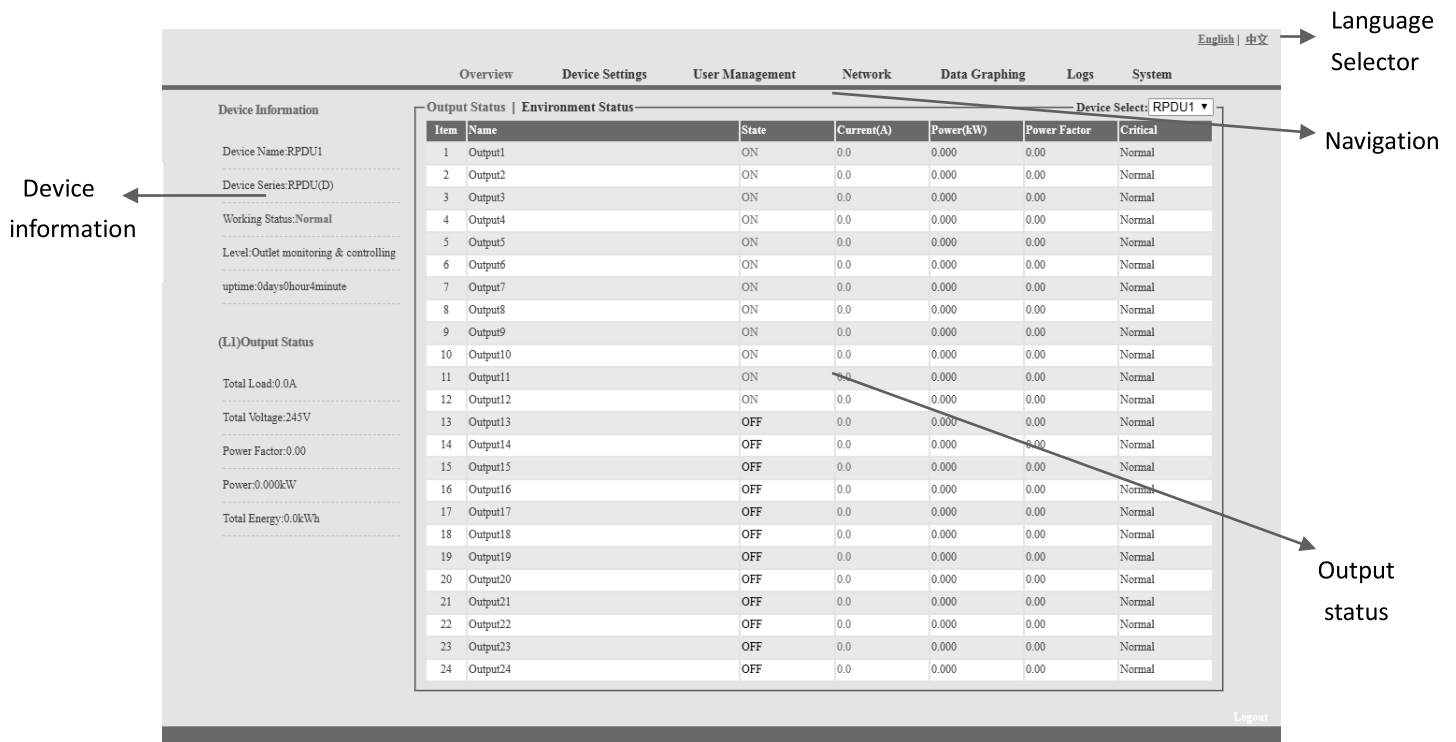

Figure 1-2

Mainly 3 parts on main interface: Navigation menu, Device information and Output status.  
 Navigation menu: show company logo and function menus and language selector.  
 Device information: display device name, device series, and device status and function level.  
 Output status: display output name, on/off state, individual current, individual power, power factor and environment status. From the drop down menu of device to check the information of Slaves.

### 3.2.1.1 Device information

**Device information** includes device name, device series, device status and function level. Output status includes total load, voltage, power factor, total power (kW) and total energy consumption (kWh).

### 3.2.1.2. Device Management: Click Device Management from menu to do basic configuration of the device like Figure 1-3

#### A. Basic settings

- a. **Work mode setting:** set the device as Master or Slave (1-4) from the drop down menu and save.
- b. **Device name setting:** re-name the devices and save.
- c. **Unitive Power delay:** enable or disable the unitive power delay, when enable the unitive power delay, the outlet will power on or off sequentially according to the unitive interval (range from 0 to 15) set. When the unitive power on/off delay was disabled, the output will power on/off sequentially according to the individual internal, please refer to the outlet settings function on page 12 (Figure 1-3-2)

- d. **Mode setting:** configure the buzzer status, enable or disable the group outlet, enable or disable the LCD screen always light on

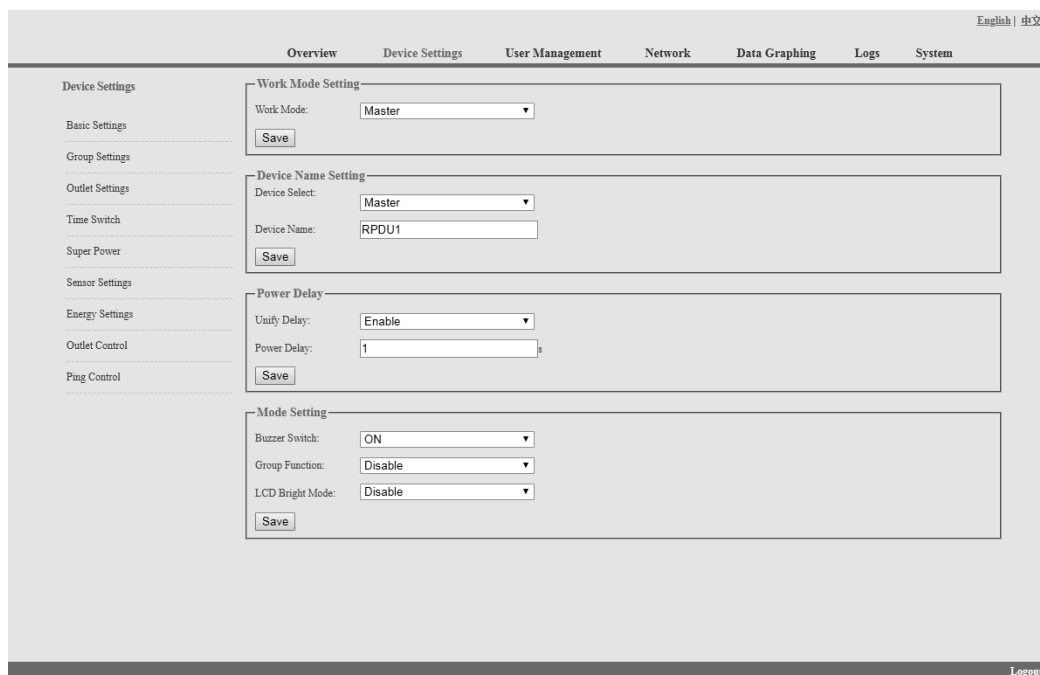

Figure 1-3

- B. **Group outlet setting:** when enabled the group outlet from the basic settings, user can tick off any outlet to 6 different groups randomly, save the operation after configuration

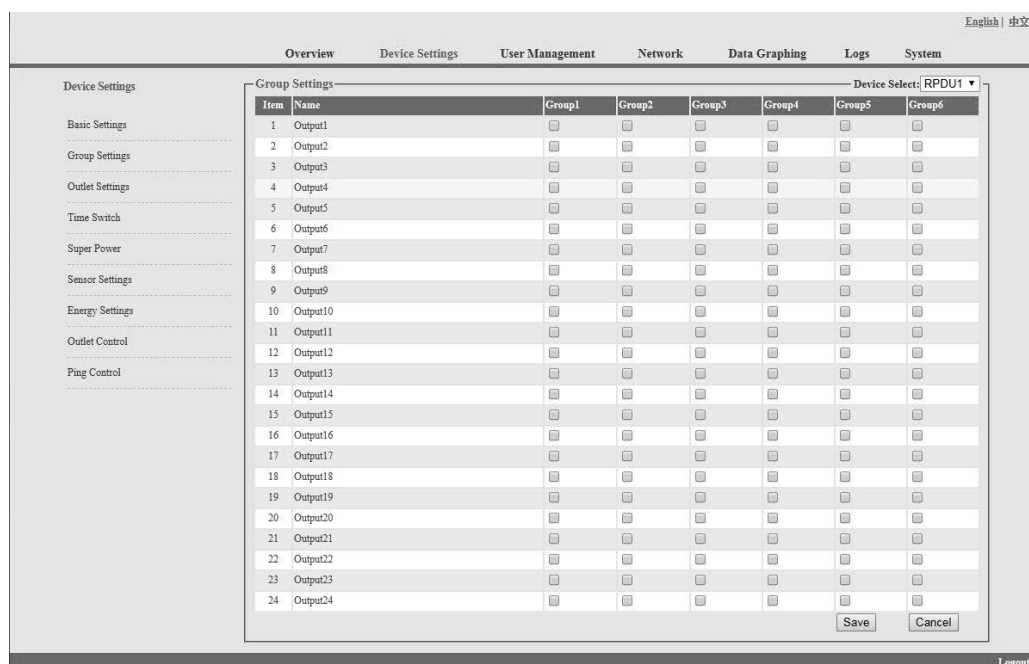

Figure1-3-1

- C. **Outlet settings:** Click **Outlet setting** from **Device management** to enter the following figure 1-3-2

- a. Outlet name: To rename each individual outlet and click save to complete
- b. The threshold of individual outlet setting: enter the user-defined threshold to alarm
- c. The near threshold of individual outlet setting: configure the near overload warning value for individual outlet
- d. Individual power delay setting: when the unitive power delay was disabled, the output will power on/off sequentially according to the individual interval (range from 0 to 15 seconds) set by user

Item	Name	Current(A)	Min(A)	Lower(A)	Upper(A)	Max(A)	Save
1	Output1	0.0	0.0	0.0	10.0	16.0	Save
2	Output2	0.1	0.0	0.0	10.0	16.0	Save
3	Output3	0.0	0.0	0.0	10.0	16.0	Save
4	Output4	0.1	0.0	0.0	10.0	16.0	Save
5	Output5	0.0	0.0	0.0	10.0	16.0	Save
6	Output6	0.0	0.0	0.0	10.0	16.0	Save
7	Output7	0.0	0.0	0.0	10.0	16.0	Save
8	Output8	0.0	0.0	0.0	10.0	16.0	Save
9	Output9	0.0	0.0	0.0	10.0	16.0	Save
10	Output10	0.0	0.0	0.0	10.0	16.0	Save
11	Output11	0.0	0.0	0.0	10.0	16.0	Save
12	Output12	0.0	0.0	0.0	10.0	16.0	Save
13	Output13	0.0	0.0	0.0	10.0	16.0	Save
14	Output14	0.0	0.0	0.0	10.0	16.0	Save
15	Output15	0.0	0.0	0.0	10.0	16.0	Save
16	Output16	0.0	0.0	0.0	10.0	16.0	Save
17	Output17	0.0	0.0	0.0	10.0	16.0	Save
18	Output18	0.0	0.0	0.0	10.0	16.0	Save
19	Output19	0.0	0.0	0.0	10.0	16.0	Save
20	Output20	0.0	0.0	0.0	10.0	16.0	Save
21	Output21	0.0	0.0	0.0	10.0	16.0	Save
22	Output22	0.0	0.0	0.0	10.0	16.0	Save
23	Output23	0.0	0.0	0.0	10.0	16.0	Save
24	Output24	0.0	0.0	0.0	10.0	16.0	Save

Figure 1-3-2

D. Schedule Outlet action: Use can schedule a specific time that each individual outlet will power on/off automatically, the time format is year-month-day hour: minutes, for example: 2015-05-27 13:52, tick off the box behind, then the outlet will power on/off according the time set;

**Note: Please calibration the device time before schedule the outlet action**

English | 中文

Overview    Device Settings    User Management    Network    Data Graphing    Logs    System

Device Settings

Basic Settings

Group Settings

Outlet Settings

Time Switch

Super Power

Sensor Settings

Energy Settings

Outlet Control

Ping Control

Device Select: RPDU1 ▾

Item	Name	Power on time	Power off time	Cycle	Select
1	Output1	1970-01-01 00:00	1970-01-01 00:00	<input type="checkbox"/>	<input type="checkbox"/>
2	Output2	1970-01-01 00:00	1970-01-01 00:00	<input type="checkbox"/>	<input type="checkbox"/>
3	Output3	1970-01-01 00:00	1970-01-01 00:00	<input type="checkbox"/>	<input type="checkbox"/>
4	Output4	1970-01-01 00:00	1970-01-01 00:00	<input type="checkbox"/>	<input type="checkbox"/>
5	Output5	1970-01-01 00:00	1970-01-01 00:00	<input type="checkbox"/>	<input type="checkbox"/>
6	Output6	1970-01-01 00:00	1970-01-01 00:00	<input type="checkbox"/>	<input type="checkbox"/>
7	Output7	1970-01-01 00:00	1970-01-01 00:00	<input type="checkbox"/>	<input type="checkbox"/>
8	Output8	1970-01-01 00:00	1970-01-01 00:00	<input type="checkbox"/>	<input type="checkbox"/>
9	Output9	1970-01-01 00:00	1970-01-01 00:00	<input type="checkbox"/>	<input type="checkbox"/>
10	Output10	1970-01-01 00:00	1970-01-01 00:00	<input type="checkbox"/>	<input type="checkbox"/>
11	Output11	1970-01-01 00:00	1970-01-01 00:00	<input type="checkbox"/>	<input type="checkbox"/>
12	Output12	1970-01-01 00:00	1970-01-01 00:00	<input type="checkbox"/>	<input type="checkbox"/>
13	Output13	1970-01-01 00:00	1970-01-01 00:00	<input type="checkbox"/>	<input type="checkbox"/>
14	Output14	1970-01-01 00:00	1970-01-01 00:00	<input type="checkbox"/>	<input type="checkbox"/>
15	Output15	1970-01-01 00:00	1970-01-01 00:00	<input type="checkbox"/>	<input type="checkbox"/>
16	Output16	1970-01-01 00:00	1970-01-01 00:00	<input type="checkbox"/>	<input type="checkbox"/>
17	Output17	1970-01-01 00:00	1970-01-01 00:00	<input type="checkbox"/>	<input type="checkbox"/>
18	Output18	1970-01-01 00:00	1970-01-01 00:00	<input type="checkbox"/>	<input type="checkbox"/>
19	Output19	1970-01-01 00:00	1970-01-01 00:00	<input type="checkbox"/>	<input type="checkbox"/>
20	Output20	1970-01-01 00:00	1970-01-01 00:00	<input type="checkbox"/>	<input type="checkbox"/>
21	Output21	1970-01-01 00:00	1970-01-01 00:00	<input type="checkbox"/>	<input type="checkbox"/>
22	Output22	1970-01-01 00:00	1970-01-01 00:00	<input type="checkbox"/>	<input type="checkbox"/>
23	Output23	1970-01-01 00:00	1970-01-01 00:00	<input type="checkbox"/>	<input type="checkbox"/>
24	Output24	1970-01-01 00:00	1970-01-01 00:00	<input type="checkbox"/>	<input type="checkbox"/>

Logout

Figure 1-3-3

### E. Power cut-off when overload

User can enable the power cut-off function accordingly, the PDU will cut off the overload outlet automatically when this function was ticked off, see figure 1-3-4

English | 中文

Overview    Device Settings    User Management    Network    Data Graphing    Logs    System

Device Settings

Basic Settings

Group Settings

Outlet Settings

Time Switch

Super Power

Sensor Settings

Energy Settings

Outlet Control

Ping Control

Device Select: RPDU1 ▾

Item	Name	Current(A)	Min(A)	Max(A)	select
1	Output1	0.0	0.0	16.0	<input type="checkbox"/>
2	Output2	0.1	0.0	16.0	<input type="checkbox"/>
3	Output3	0.0	0.0	16.0	<input type="checkbox"/>
4	Output4	0.1	0.0	16.0	<input type="checkbox"/>
5	Output5	0.0	0.0	16.0	<input type="checkbox"/>
6	Output6	0.0	0.0	16.0	<input type="checkbox"/>
7	Output7	0.0	0.0	16.0	<input type="checkbox"/>
8	Output8	0.0	0.0	16.0	<input type="checkbox"/>
9	Output9	0.0	0.0	16.0	<input type="checkbox"/>
10	Output10	0.0	0.0	16.0	<input type="checkbox"/>
11	Output11	0.0	0.0	16.0	<input type="checkbox"/>
12	Output12	0.0	0.0	16.0	<input type="checkbox"/>
13	Output13	0.0	0.0	16.0	<input type="checkbox"/>
14	Output14	0.0	0.0	16.0	<input type="checkbox"/>
15	Output15	0.0	0.0	16.0	<input type="checkbox"/>
16	Output16	0.0	0.0	16.0	<input type="checkbox"/>
17	Output17	0.0	0.0	16.0	<input type="checkbox"/>
18	Output18	0.0	0.0	16.0	<input type="checkbox"/>
19	Output19	0.0	0.0	16.0	<input type="checkbox"/>
20	Output20	0.0	0.0	16.0	<input type="checkbox"/>
21	Output21	0.0	0.0	16.0	<input type="checkbox"/>
22	Output22	0.0	0.0	16.0	<input type="checkbox"/>
23	Output23	0.0	0.0	16.0	<input type="checkbox"/>
24	Output24	0.0	0.0	16.0	<input type="checkbox"/>

Logout

Figure 1-3-4

F. Sensor settings: set the threshold of temperature, humidity as figure 1-3-5

The screenshot shows the 'Device Settings' page for 'RPDU1'. The 'Sensor Settings' section is active, displaying a table with 10 rows. The table columns are Item, Name, Current value, Min, Max, and Save. The 'Save' column contains 'Save' buttons for each row. The 'Min' and 'Max' columns contain input fields with values ranging from 0 to 99. The 'Current value' column shows the current sensor readings.

Item	Name	Current value	Min	Max	Save
1	Temperature1	25	0	40	Save
2	Temperature2	25	0	40	Save
3	Temperature3	26	0	40	Save
4	Temperature4	0	0	40	Save
5	Humidity1	65	0	99	Save
6	Humidity2	63	0	99	Save
7	Humidity3	65	0	99	Save
8	Humidity4	0	0	99	Save
9	Total Load(L1)	0.2	0.0	32.0	Save
10	Total Load(L2)	0.0	0.0	32.0	Save

Figure 1-3-5

G. Energy setting: Click the **Energy setting** form the **Device Management** menu as Figure 1-3-6  
 User can view the power consumption of each individual and click the Reset button to return the kWh to zero, the total power consumption will take off the outlet consumption as well.

English | 中文

Overview    Device Settings    User Management    Network    Data Graphing    Logs    System

Device Settings

Basic Settings

Group Settings

Outlet Settings

Time Switch

Super Power

Sensor Settings

Energy Settings

Outlet Control

Ping Control

Energy Settings Device Select: RPDU1 ▾

Item	Name	Energy(kWh)	Reset
1	Output1	0.0	Energy reset
2	Output2	0.0	Energy reset
3	Output3	0.0	Energy reset
4	Output4	0.0	Energy reset
5	Output5	0.0	Energy reset
6	Output6	0.0	Energy reset
7	Output7	0.0	Energy reset
8	Output8	0.0	Energy reset
9	Output9	0.0	Energy reset
10	Output10	0.0	Energy reset
11	Output11	0.0	Energy reset
12	Output12	0.0	Energy reset
13	Output13	0.0	Energy reset
14	Output14	0.0	Energy reset
15	Output15	0.0	Energy reset
16	Output16	0.0	Energy reset
17	Output17	0.0	Energy reset
18	Output18	0.0	Energy reset
19	Output19	0.0	Energy reset
20	Output20	0.0	Energy reset
21	Output21	0.0	Energy reset
22	Output22	0.0	Energy reset
23	Output23	0.0	Energy reset
24	Output24	0.0	Energy reset
All Energy			Energy reset

Logout

Figure 1-3-6

- H. Outlet control: Click the **Outlet control** form the **Device Management** menu as Figure 1-3-6
- a. User can switch on/off/reboot each individual outlet by click the corresponding on/off/reboot buttons;
  - b. Also user can switch on or off all socket at once by click the ALL on/off button

Overview    Device Settings    User Management    Network    Data Graphing    Logs    System

Device Settings

Basic Settings

Group Settings

Outlet Settings

Time Switch

Super Power

Sensor Settings

Energy Settings

Outlet Control

Ping Control

Outlet Control ————— Device Select: RPDU1

Item	Name	Status	On	Off	Cycle
1	Output1	ON	On	Off	Cycle
2	Output2	ON	On	Off	Cycle
3	Output3	ON	On	Off	Cycle
4	Output4	ON	On	Off	Cycle
5	Output5	ON	On	Off	Cycle
6	Output6	ON	On	Off	Cycle
7	Output7	ON	On	Off	Cycle
8	Output8	ON	On	Off	Cycle
9	Output9	ON	On	Off	Cycle
10	Output10	ON	On	Off	Cycle
11	Output11	ON	On	Off	Cycle
12	Output12	ON	On	Off	Cycle
13	Output13	ON	On	Off	Cycle
14	Output14	ON	On	Off	Cycle
15	Output15	ON	On	Off	Cycle
16	Output16	ON	On	Off	Cycle
17	Output17	ON	On	Off	Cycle
18	Output18	ON	On	Off	Cycle
19	Output19	ON	On	Off	Cycle
20	Output20	ON	On	Off	Cycle
21	Output21	ON	On	Off	Cycle
22	Output22	ON	On	Off	Cycle
23	Output23	ON	On	Off	Cycle
24	Output24	ON	On	Off	Cycle
	ALL		On	Off	

Logout

Figure 1-3-7

## I. Ping Control

Use the PING command to ping the corresponding outlets network device's IP address from the first to eighth outlets, When Ping no answer occurs, by the control of outlets' power up/down so as to realize the power supply operation of network equipment.

- Fill in the corresponding input IP address in the IP input box, which is controlled by network device.
- Select the drop-down box options of ACTION, the default system command is NONE, PING- no answer, the system does not perform any operation of corresponding outlets; When you select ON / OFF / Once Options, Ping-No answer occurs, the system will perform the corresponding outlets on/off or restart an operation; When you select Cycle option, Ping No answer occurs, the corresponding outlets will repeat restart operation at intervals of time.
- The interval time of outlets restart command operation is 3s (system default), the range shouldn't be less than 3s. Click on "Apply" button, Ping function enable, when Ping function is enabled, the logs of the operation of Ping function will be generated.

**Note:** when Ping running normal, the outlets doesn't carry on any operates commands. The other outlets connect the network device IP couldn't be available this function.



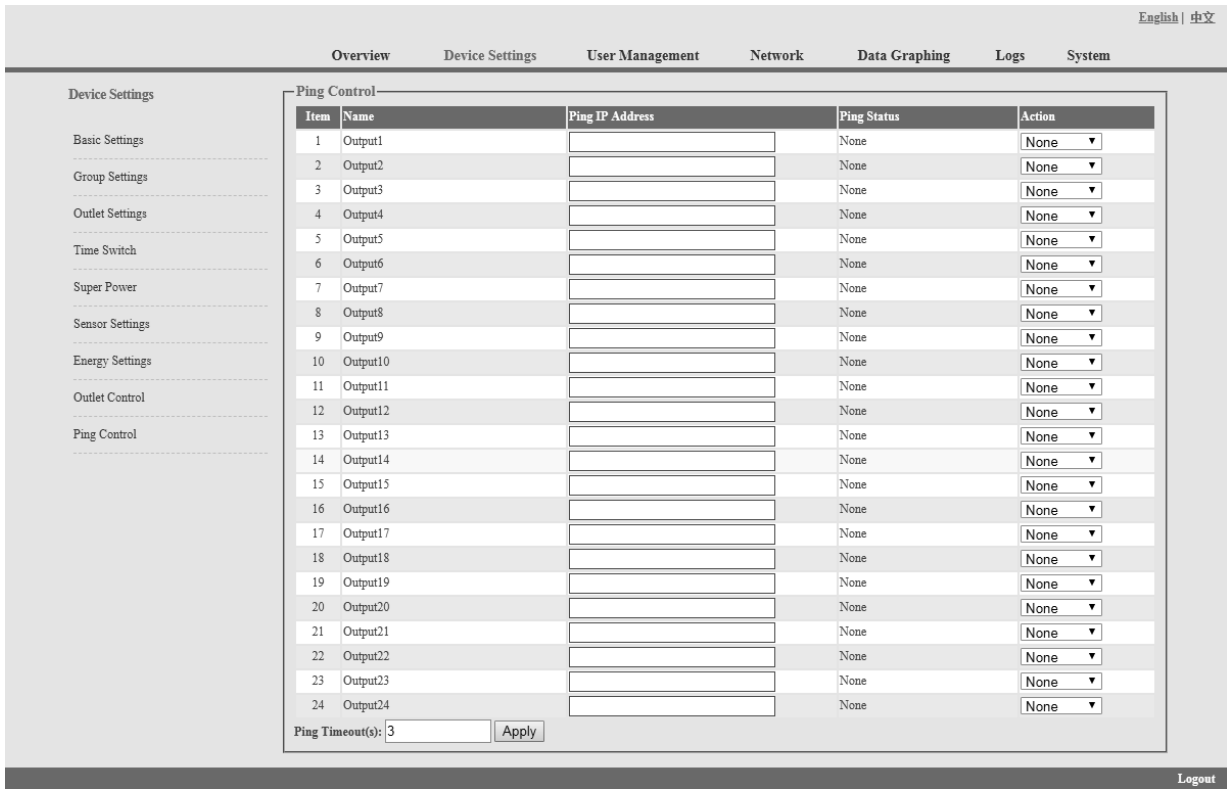

Figure 1-3-8

**3.2.1.3. User Management: Click the User Management form the navigation bar as Figure 1-4 to manage the user, user group and user access rights**

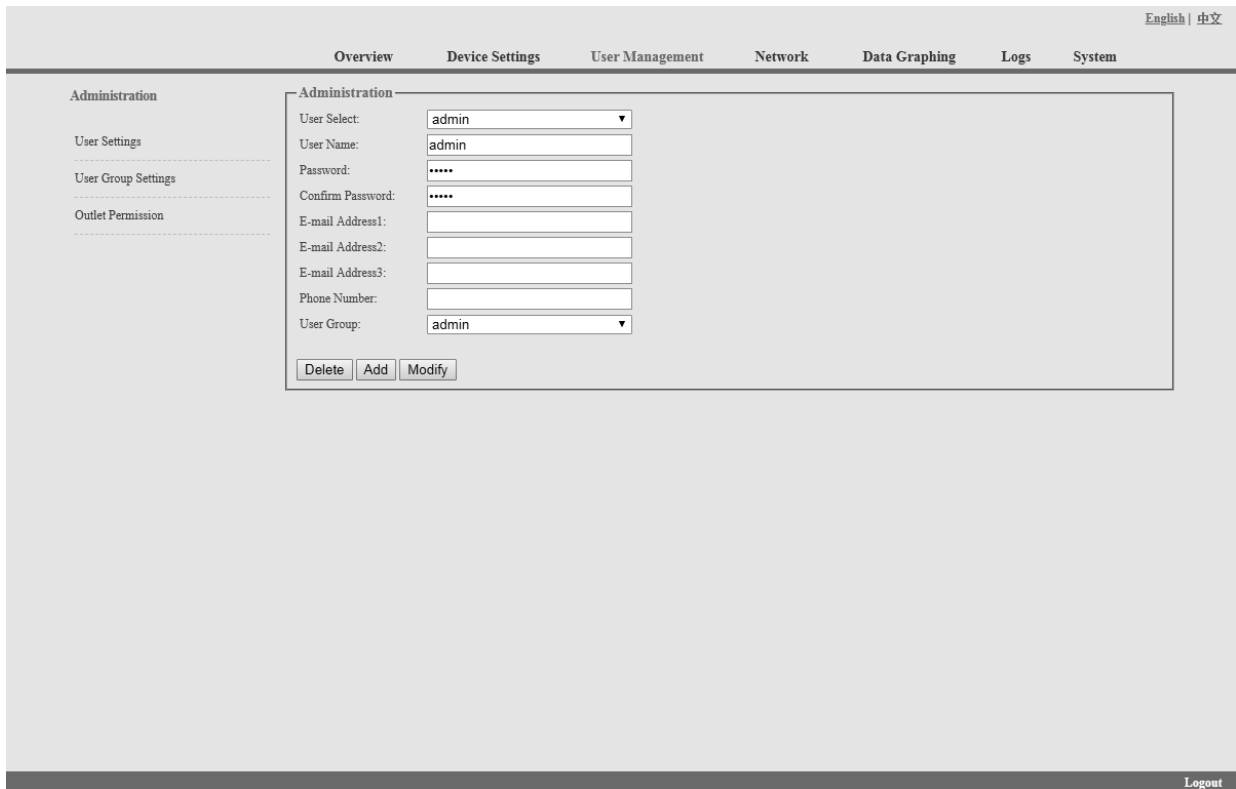

Figure 1-4

- A. User Settings: Click the User settings from the User Management menu as figure 1-4
1. Create new account: Click user settings and fill in the new user name and password, click Add to finish
  2. Edit account: Click User settings, fill in the changed user name and password in the right side, click Modify to finish
  3. Delete account: Click User settings and select the account from the drop down list, then click **Delete** to finish
  4. Create new user group: Click User Group Settings, fill in the new user group name and configure the corresponding rights, then click Save to finish, see as figure 1-4-1

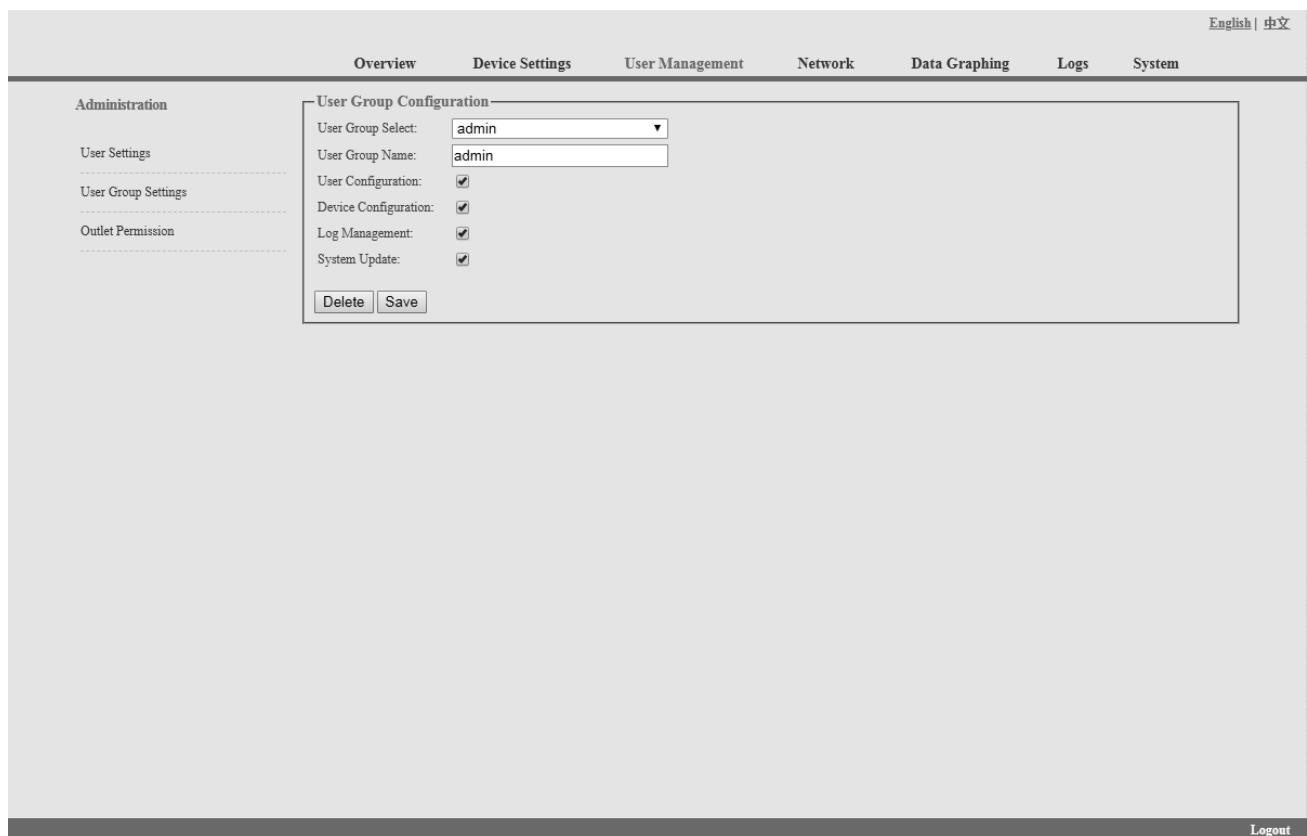

Figure 1-4-1

5. Edit the User Group: Click the User Group settings, then fill in the changed user group name and click Save to finish
6. Delete user group: Click User Group settings, select the user group from the drop down list and click Delete button to finish
7. Edit the User Group rights: Select the User Group from the drop down list and tick off the rights accordingly, click save to finish

User can assign different outlet access rights to different user groups, click Save or Delete to finish. See as figure 1-4-2

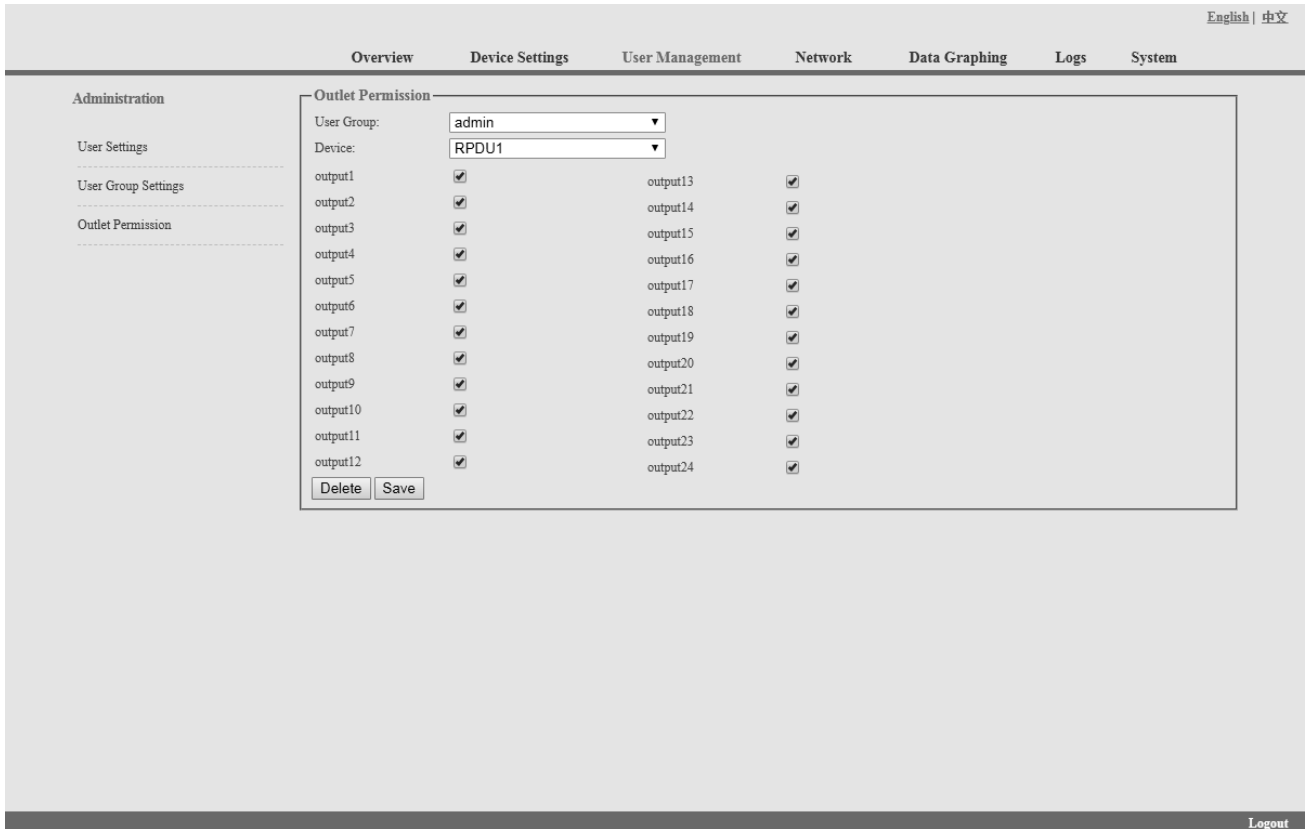

Figure 1-4-2

### 3.2.1.4 Network Settings: Click the Network Settings from the navigation bar as figure 1-5

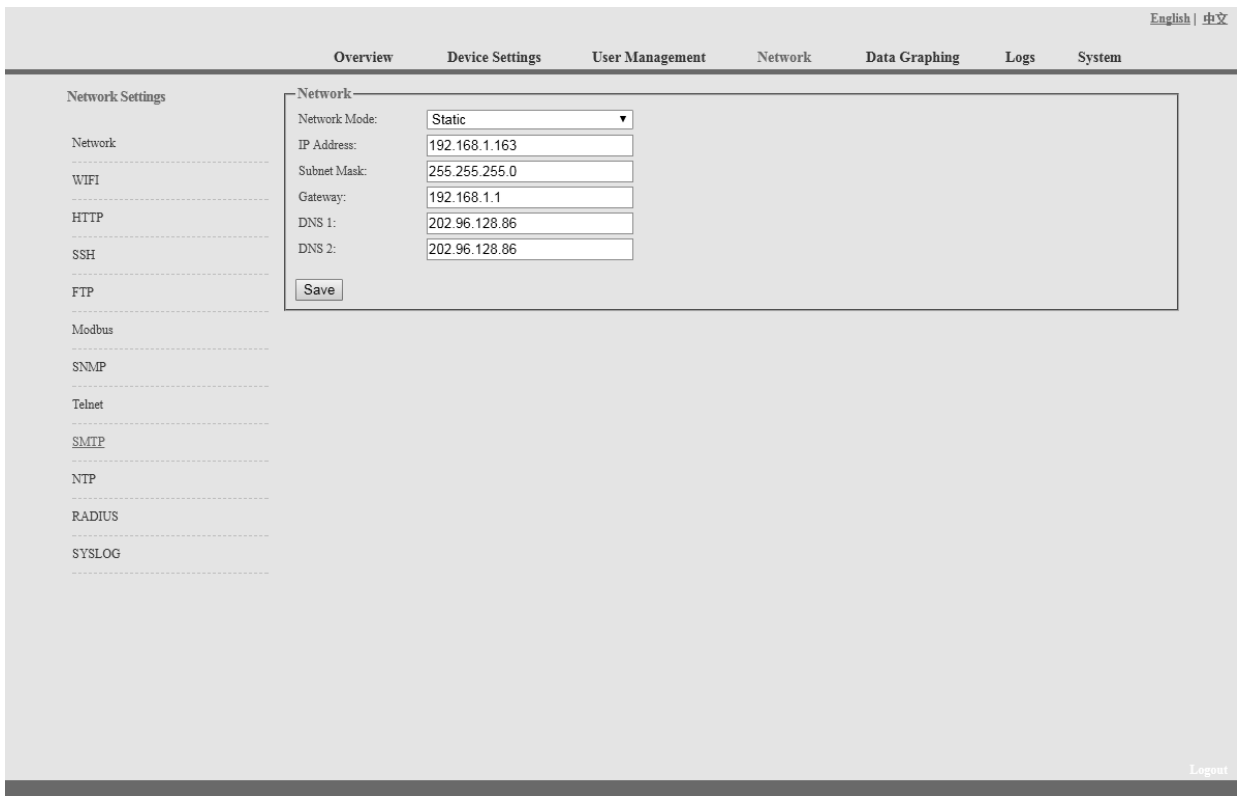

Figure 1-5

**Note: the network settings including Network, WIFI, HTTP, SSH, FTP, Modbus, SNMP, Telnet, SMTP, NTP, Radius and SYSOLOG sections**

A. Network: User can configure the network by manual or automatic acquisition.

a. Manual setting:

IP: 192.168.1.163 ( factory default IP ) ;

Subnet mask: 255.255.255.0

Gateway: 192.168.1.1

DNS: default as 0.0.0.0; should fill in correct DNS to ensure the email send out.

**Note: please restart the software after the modification of network settings.**

b. Automatic acquisition:

Select Automatic acquisition and click "Save", then restart the software, device will get the IP automatically. IP can be viewed on LCD.

B. WIFI Settings:

Insert the wireless network card into the USB port

1. WIFI Signal Searching:

Click "Search Network" to find all the wireless network nearby.

2. Enable WIFI: select enable, fill in SSID and password and save.

3. WIFI network settings

Network mode can be manual or automatic acquisition

Manually settings as below:

IP Address: Set the WIFI IP in the LAN like 192.168.1.191

Subnet Mask: correspond to IP address like 255.255.255.0

Gateway: correspond to IP address like 192.168.1.1

DNS: default DNS is 0.0.0.0

Automatic acquisition

Fill out the WIFI connection settings and save, select the automatic acquisition from the drop-down list of WIFI network settings and save. Then restart the device and system will acquire the IP address within the LAN and the address can be viewed from the LCD screen.

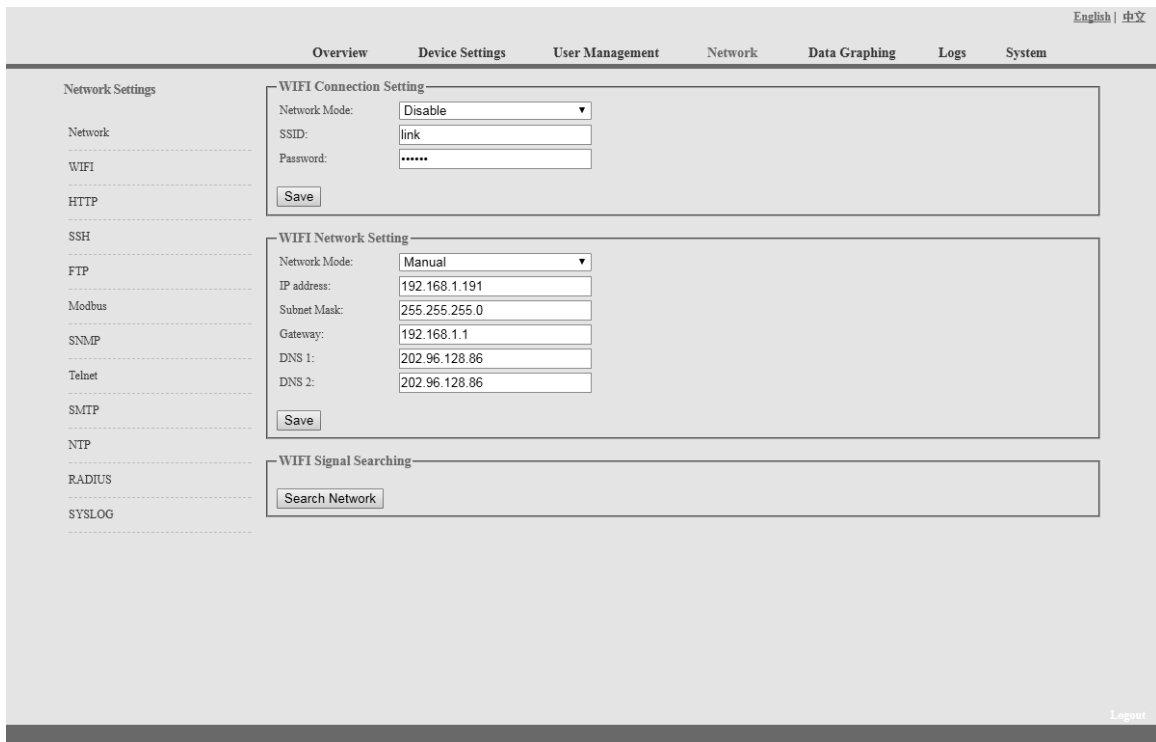

Figure 1-6

C. HTTP: fill in the correct HTTP port and save; under normal work mode, the default port is 80. HTTPS (SSL) Mode Port: default as 443.

**Note:** please restart the software after the modification of HTTP settings. See figure 1-7

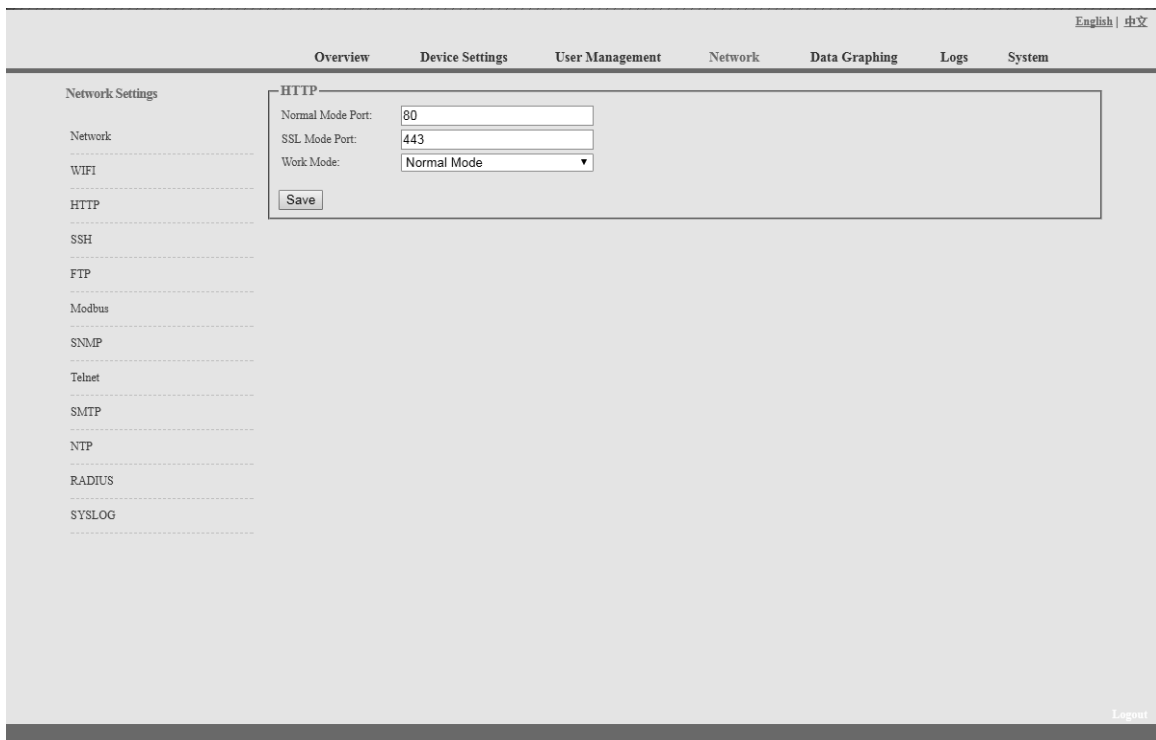

Figure 1-7

#### D. SSH Setting:

User can enable or disable the SSH, it require restart the device after saving the configuration. The account and password of SSH is the account and password to login to the SSH, the SSH port is 22, see figure 1-8:

**Note: SSH command line access, please refer to the Telnet access instruction**

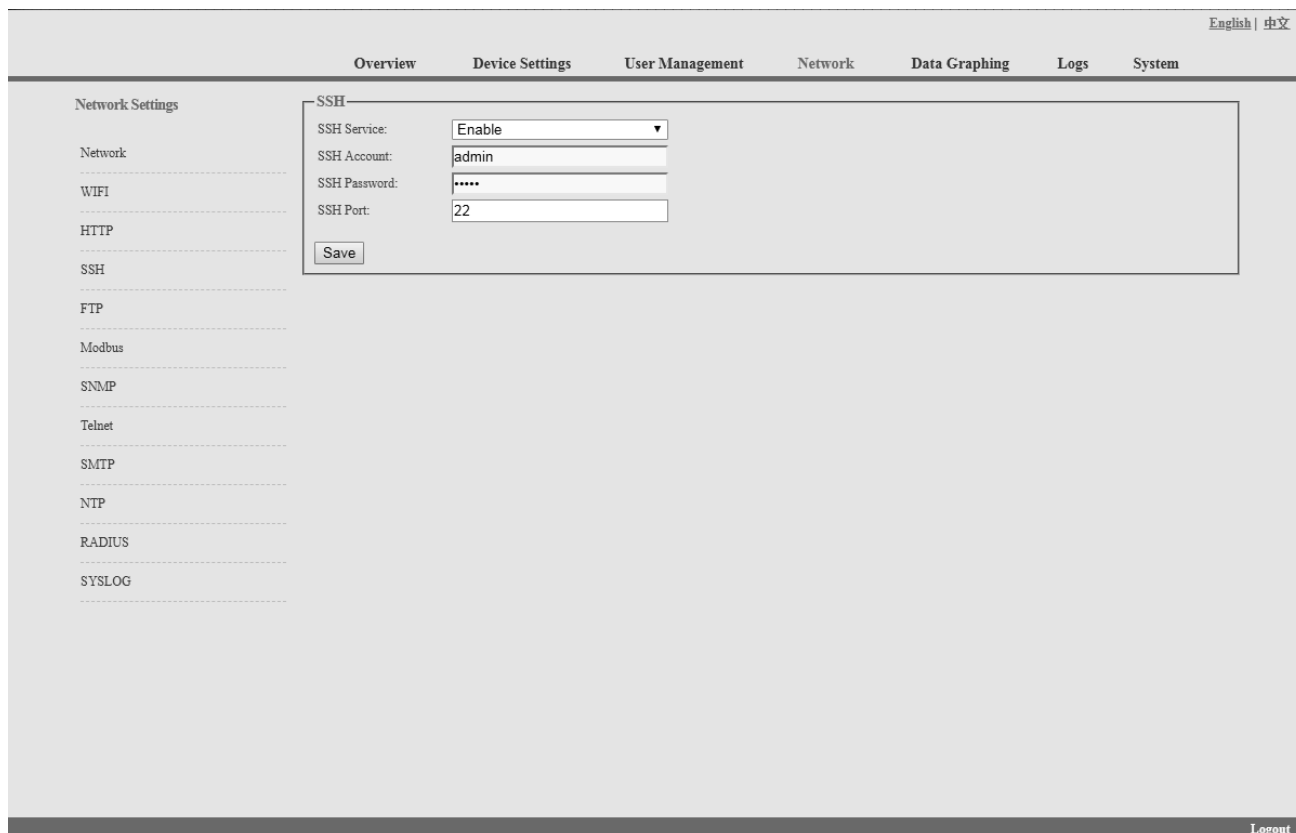

Figure 1-8

#### E. FTP

User can enable or disable the FTP, it require restart the device after saving the configuration. The account and password of FTP is the account and password to login to the SSH, the FTP port is 21, see figure 1-9:

**Note: User can remotely upgrade by enable the FTP service**

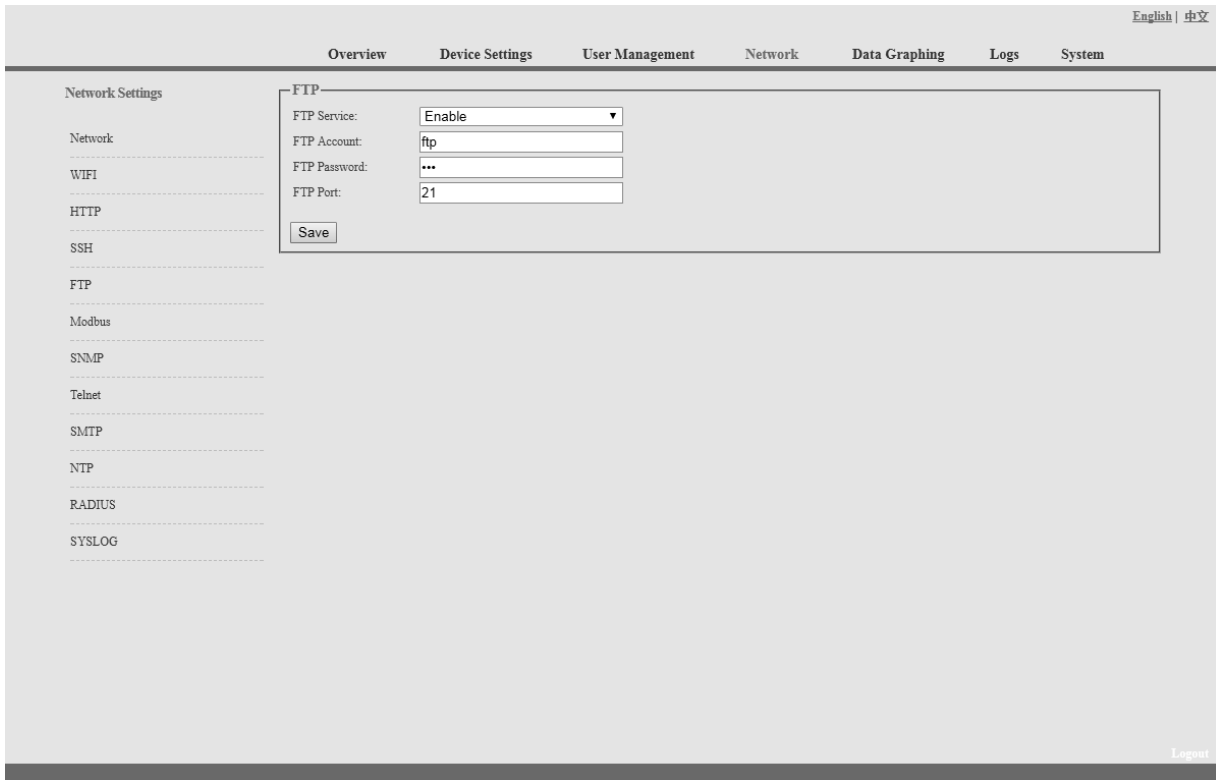

Figure 1-9

#### F. MODBUS

MODBUS protocol configuration includes MODBUS communication address(1-255), baud rate(9600,19200,38400,57600,115200), data bit(6,7,8), parity (N/A, even number, odd number), stop bit(1,2)

**Note: The Master unit collects the data from the SER port; please refer to the MODBUS protocol detail for reference.**

**The SER interface of horizontal SMART PDU supports either modbus serial port function or external extended sensor box function.**

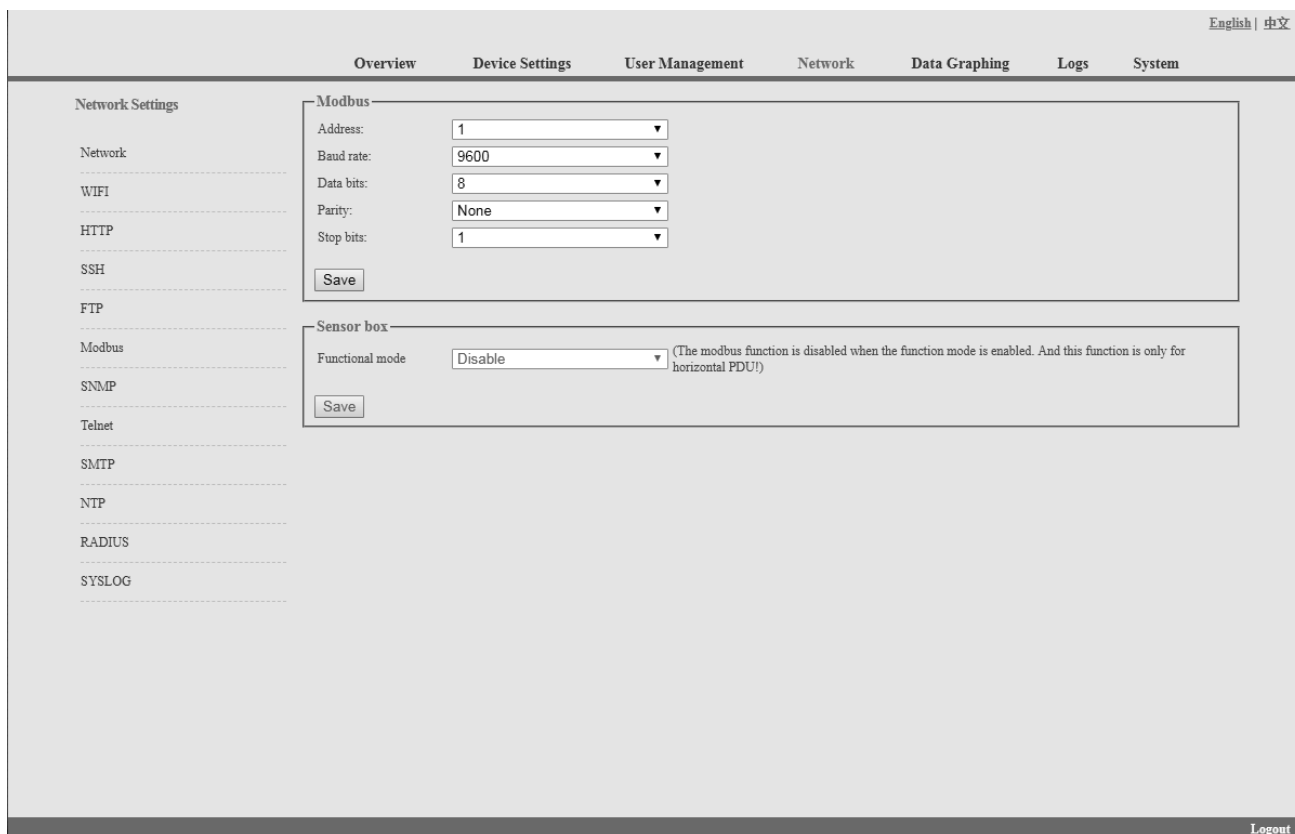

Figure 1-10

## G. SNMP:

### SNMP V1/V2c:

User can decide to Enable or Disable the SNMP access from the Web interface.

Enable SNMP V1 and V2C requires configuration of read community and write community.

And the default "Read community" and "Write community" is public and private.

User can change it accordingly to situation.

Trap address: can set 2 trap addresses. Fill in the trap address of SNMP management platform, Trap information will be sent directly to the addresses.

SNMP server position record the server position information

SNMP v3 settings:

Select "Enable" and fill in account, password, and private key.

**Note: After save of the SNMP setting, software must be restarted.**

**For SNMP access please refer to page 24.**



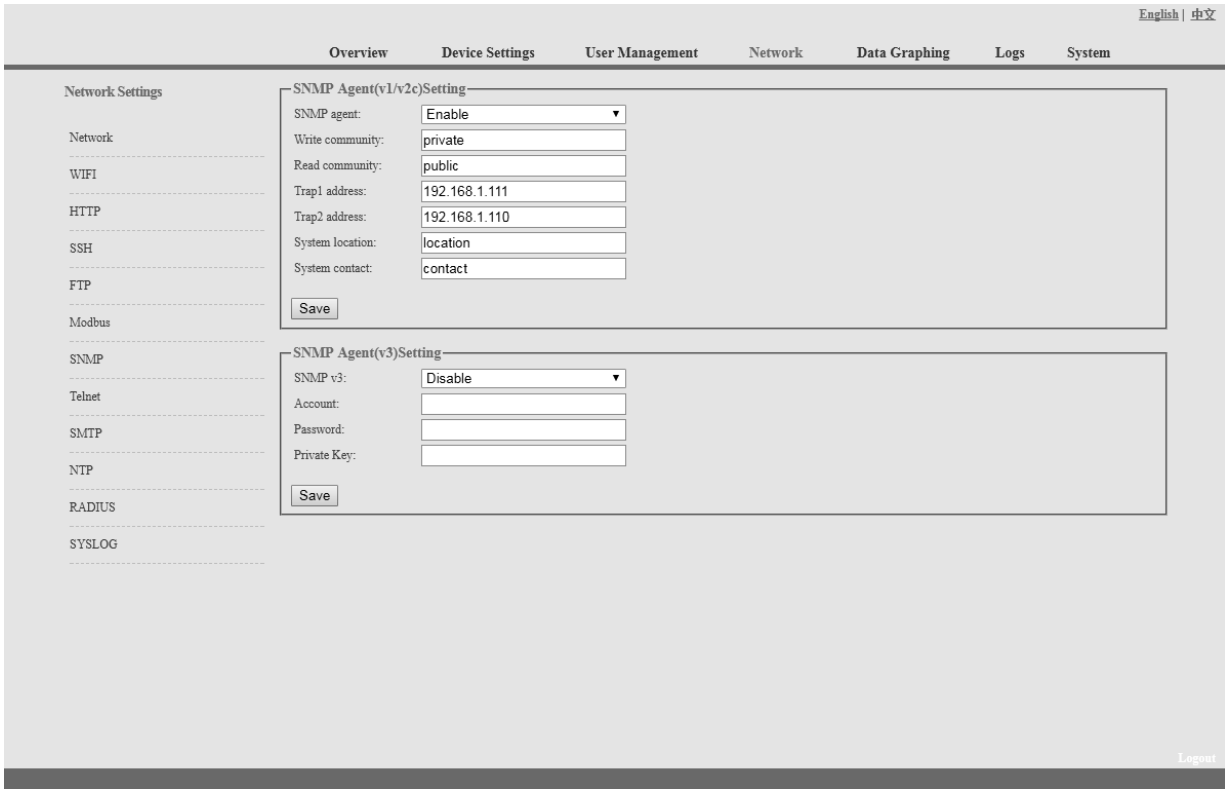

Figure

1-11

#### H. Telnet:

Telnet: select “Enable” or “Disable” and save, make sure to restart the software after modification. Fill in Telnet account and password as shown in figure 1-12, Telnet port is 23.

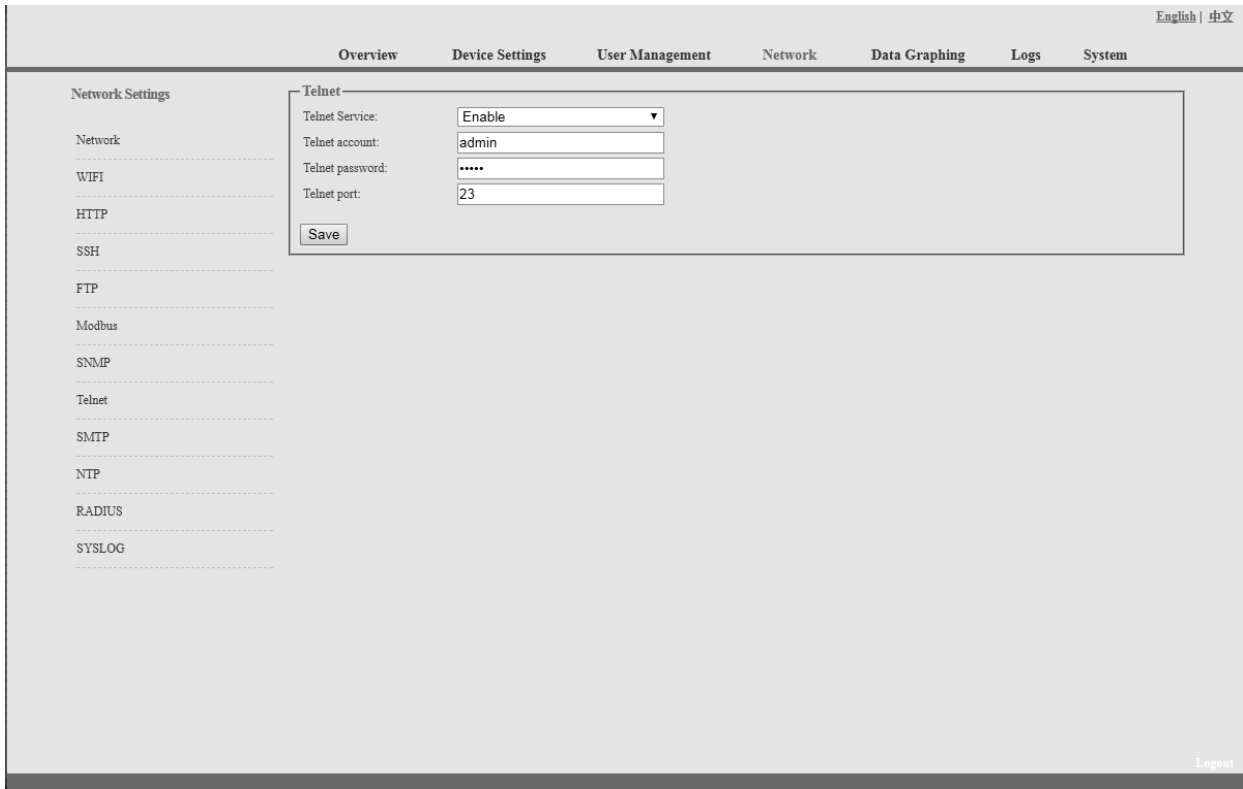

Figure 1-12

I. SMTP: Click SMTP from the network setting tap to enter the SMTP setting as figure 1-13.

Fill in the parameters of SMTP service including SMTP account, password, SMTP server, port and authentication mode. After save, must restart the software to take effect.

SMTP test: fill in the receiver account, click “Test” and then check the test receiver account. If test email received, SMTP setting is successful; if not received, please reset the SMTP.

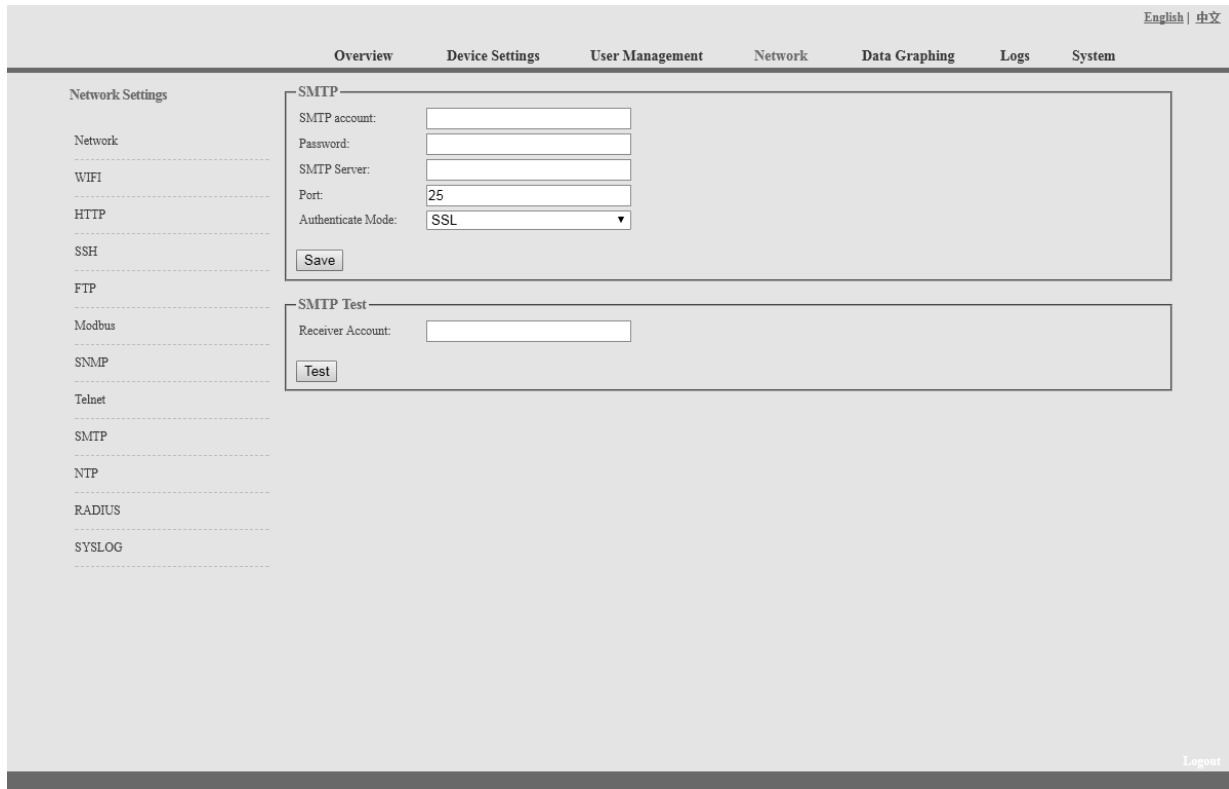

Figure 1-13

J. NTP Settings: Click NTP as shown figure 1-14 from network setting tap

Local time is the present time of the device server.

To enable or Disable the NTP service and click Save. Then restart the device.

Enable NTP; fill in the NTP server, port and select time zone, click "Save".

Click "Synchronization", device will update to the local system time according to the current time zone and date from the internet

User-defined setting: must disable the NTP firstly and then fill in the date and time.

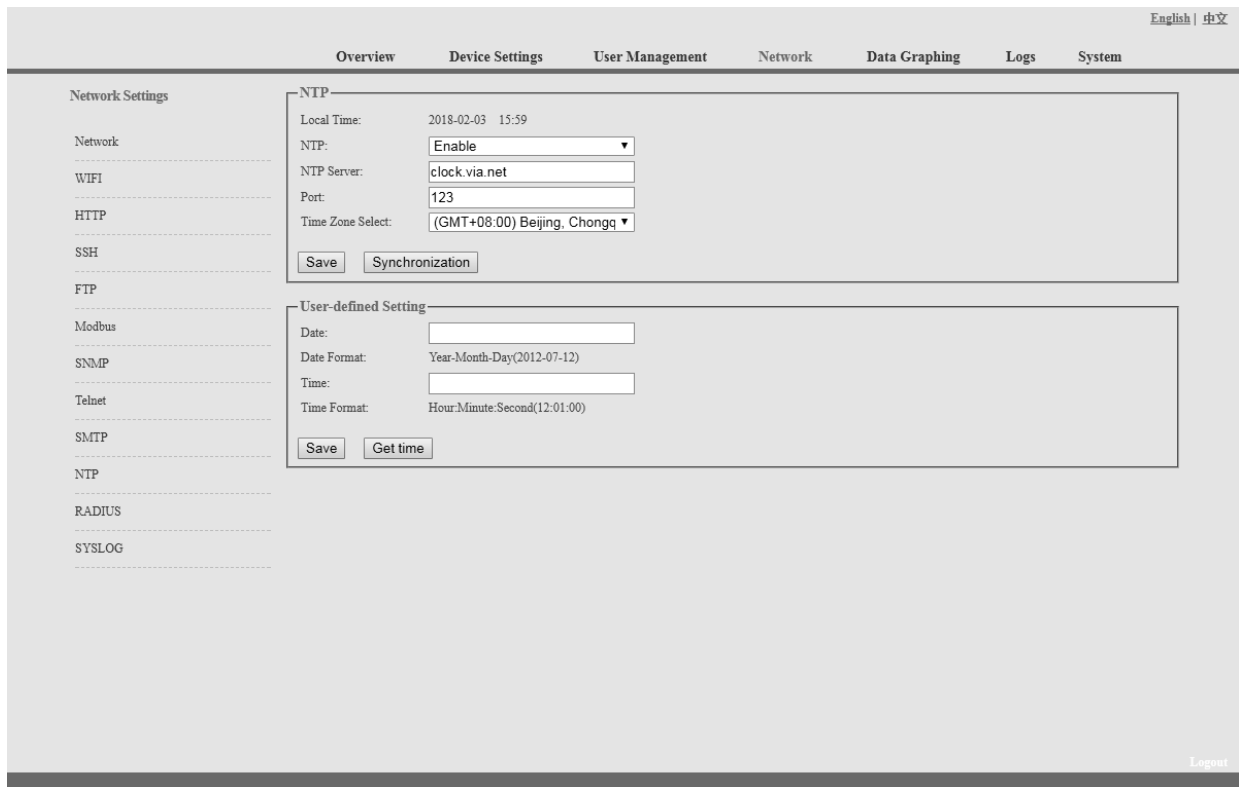

Figure 1-14

## K. RADIUS

User can choose basic authentication or Radius authentication.

Select Radius authentication, device will authenticate the user account from the Radius server.

Server address: fill in the Radius server address.

Shared secret: fill in the required public key of the Radius server.

**Note: please restart the software after the configuration. Then fill in the requested account and password of Radius server, after authentication, user can access the device.**

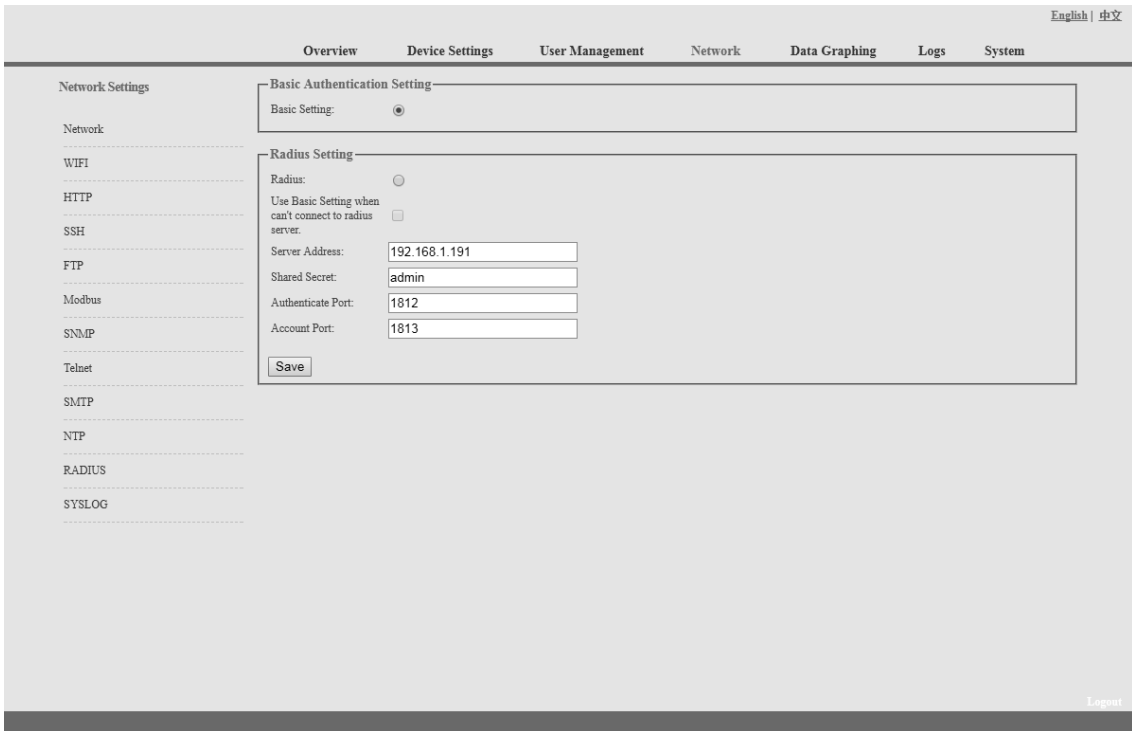

Figure 1-15

L. SYSLOG: fill in the SYSLOG server IP address as shown in figure 1-16

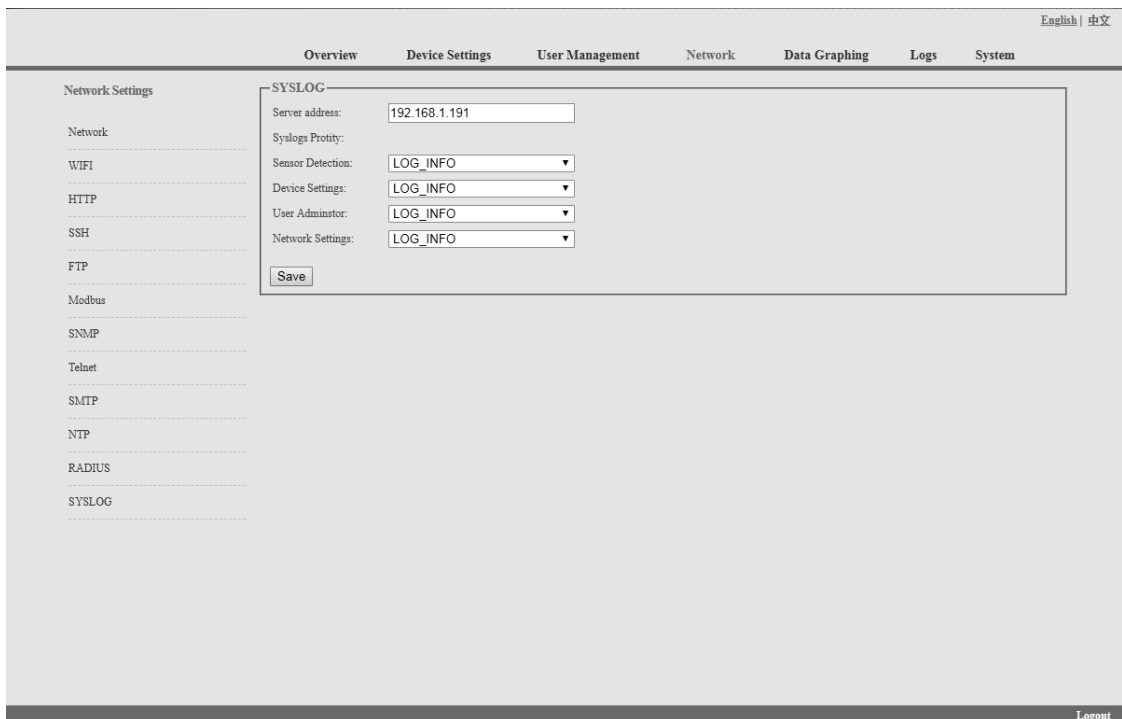

Figure 1-16

**Note: SYSLOG contain the system start, service mistake during operation and command mistake information. After save the SYSLOG server address, restart the software to take effect.**

### 2.1.5. Data Graphing

Select device and check the relative information in the past 24 hours including total power (kW), current (ampere), voltage, average temperature and humidity as illustrated in figure 1-17

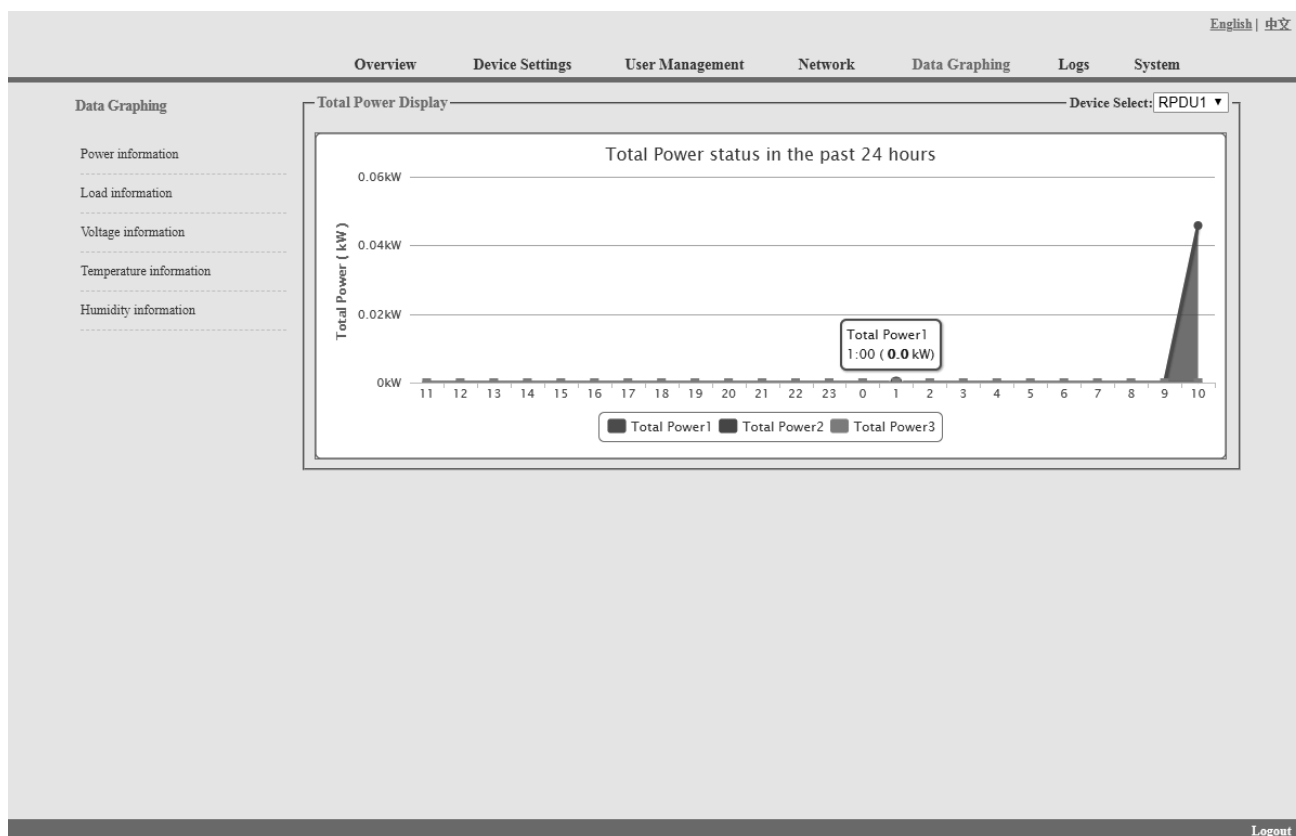

Figure 1-17

### 3.2.1.6. Logs

Click **Logs** from the navigation bar to enter the logs interface as shown in figure 1-18, it contains events, history data and energy data. See also figure 1-19 and 1-20

Logs Record: show the operation time, log type, user name and log details.

Memory capacity 100M.

To view the data:

Jump: enter the page you want to view and it will switch over to the specific page.

Page turning: by click Next or Previous to view the logs

Delete the logs:

Click the **delete logs**, device will return the confirmation and click OK to delete all the logs.

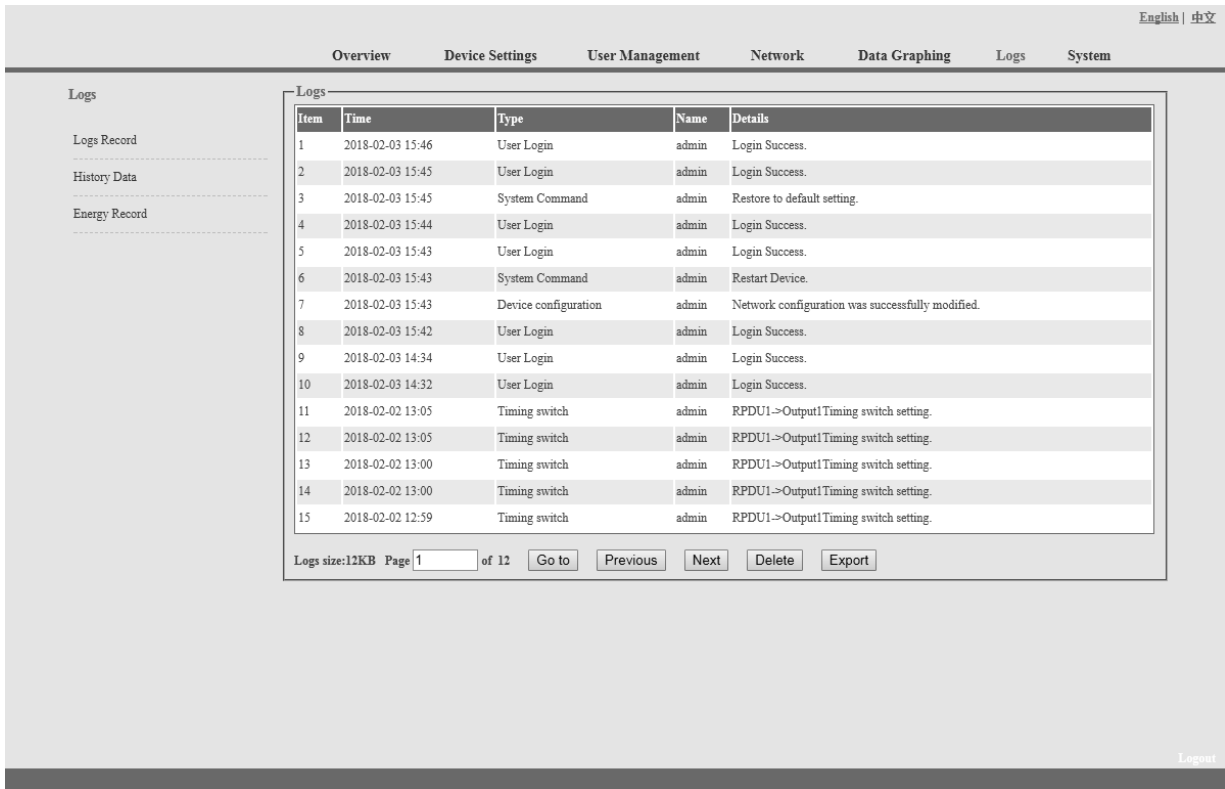

Figure 1-18

History Data: select the date, device and information type (total power, voltage, power, temperature and humidity) want to view, and then click “View” to see the history data. Figure 1-19 shows the voltage status of 24 hours:

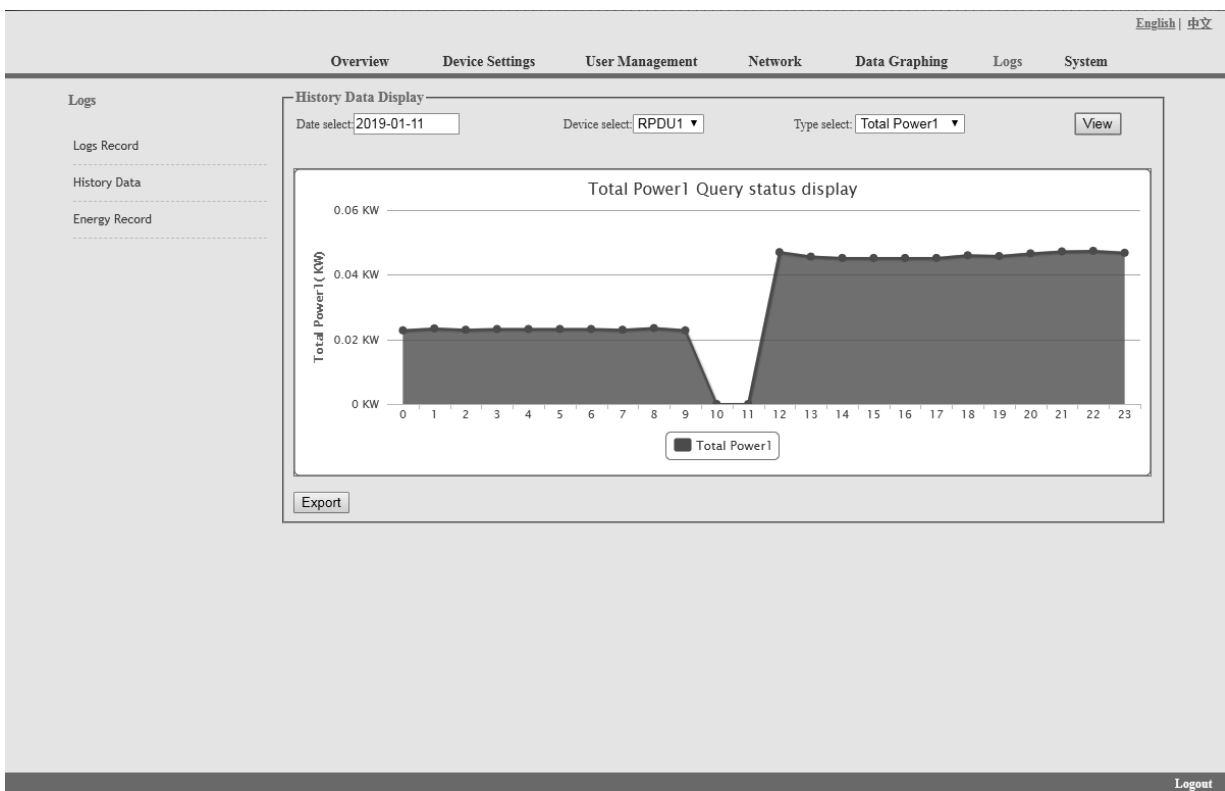

Figure 1-19

Energy Record: select the device, start and end date, and click “View”, system will show the accumulated kWh value on the two date and calculate the kWh value during that period as shown in figure 1-20:

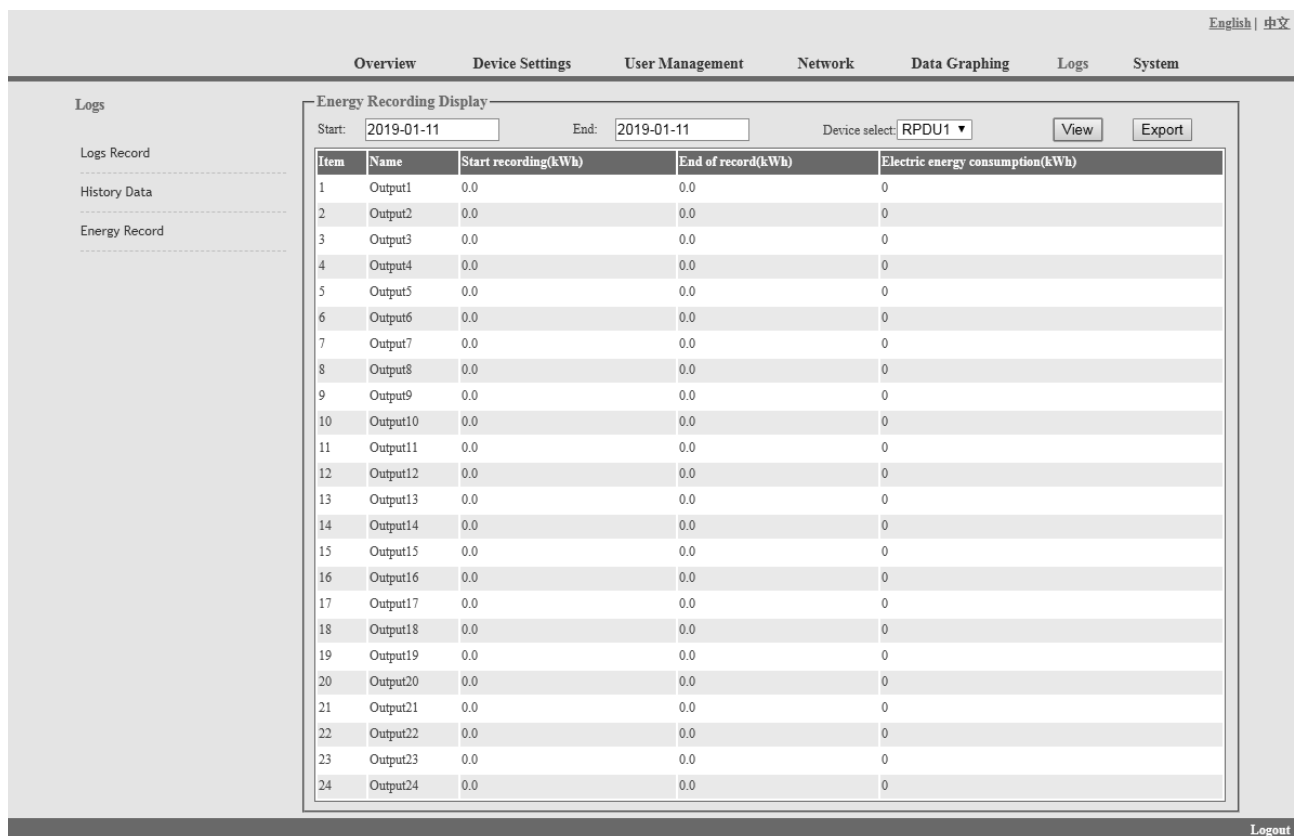

Figure 1-20

### 3.2.1.7. System

Click **System** from the navigation bar to enter the system interface as shown in figure 1-21

1. show system information: User can check system version, last update date, flash size and so on ;
2. download update tool to remotely update the software provided;
3. download user manual and MIB file ;
4. Massive data backup and quick setup of mass PDUs: Click Settings to save the devices settings, user settings and network settings through batch download, user can upload all the backup information easily by the upgrade tool.
5. User can easily upgrade the software version through the Rootfs.bin file provided by following up the instruction to upload the software.

**Note: Please make sure the PDU is directly connected to the PC.**

**Ensure no power off, no network disconnection and no operation during upgrading.**

6. Restart the software or restore to factory default configuration from the **System commands**.



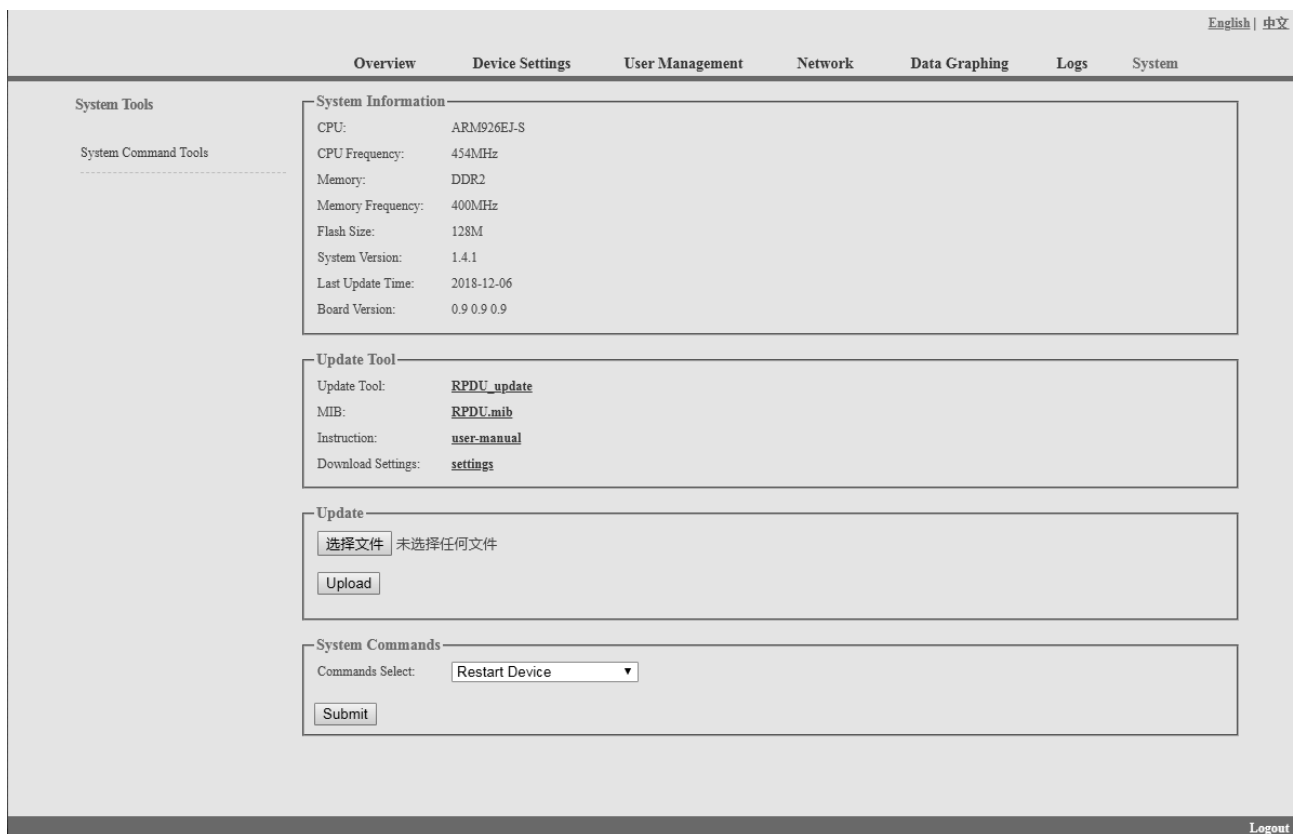

Figure 1-21

### 3.2.2 SNMP Access

This software support SNMP V1, V2C and V3, a MIB file can be provided at customer's request. User can view the power information and environment status and receive the alarming from the device.

After enable the SNMP function from Web interface. A SNMP management software is required to be installed (the first device can be the Master unit or Slave unit, and the others are all Slave units). Please refer to the OID table as below:

	OID	Description
SMART PDUSlave X	1.3.6.1.4.1.30966.6.X	Device X
slave X Name	1.3.6.1.4.1.30966.6.X.1.1	Name of device X
slave X Type	1.3.6.1.4.1.30966.6.X.1.2	Type of device X
slave X Line One	1.3.6.1.4.1.30966.6.X.1.3	Phase one of device X
slave X Line One Power	1.3.6.1.4.1.30966.6.X.1.3.1	Power of phase one of device X
slave X Line One PF	1.3.6.1.4.1.30966.6.X.1.3.2	Power factor of the phase one of device X
slave X Line One Energy	1.3.6.1.4.1.30966.6.X.1.3.3	Energy of phase one of device X
slave X Line One Current	1.3.6.1.4.1.30966.6.X.1.3.4	Current of phase one of device X
slave X Line One Voltage	1.3.6.1.4.1.30966.6.X.1.3.5	voltage of phase one of device X
slave X Line One Current Min	1.3.6.1.4.1.30966.6.X.1.3.6	Minimum Current of phase one of device X
slave X Line One Current Max	1.3.6.1.4.1.30966.6.X.1.3.7	Maximum Current of phase one of device X

slave X Line One Voltage Min	1.3.6.1.4.1.30966.6.X.1.3.8	Minimum voltage of phase one of device X
slave X Line One Voltage Max	1.3.6.1.4.1.30966.6.X.1.3.9	Maximum voltage of phase one of device X
slave X Line Two	1.3.6.1.4.1.30966.6.X.1.4	Phase two of device X
slave X Line Two Power	1.3.6.1.4.1.30966.6.X.1.4.1	Power of phase two of device X
slave X Line Two PF	1.3.6.1.4.1.30966.6.X.1.4.2	Power factor of the phase two of device X
slave X Line Two Energy	1.3.6.1.4.1.30966.6.X.1.4.3	Energy of phase two of device X
slave X Line Two Current	1.3.6.1.4.1.30966.6.X.1.4.4	Current of phase two of device X
slave X Line Two Voltage	1.3.6.1.4.1.30966.6.X.1.4.5	voltage of phase two of device X
slave X Line Two Current Min	1.3.6.1.4.1.30966.6.X.1.4.6	Minimum Current of phase two of device X
slave X Line Two Current Max	1.3.6.1.4.1.30966.6.X.1.4.7	Maximum Current of phase two of device X
slave X Line Two Voltage Min	1.3.6.1.4.1.30966.6.X.1.4.8	Minimum voltage of phase two of device X
slave X Line Two Voltage Max	1.3.6.1.4.1.30966.6.X.1.4.9	Maximum voltage of phase two of device X
slave X Line Three	1.3.6.1.4.1.30966.6.X.1.5	Phase three of device X
slave X Line Three Power	1.3.6.1.4.1.30966.6.X.1.5.1	Power of phase three of device X
slave X Line Three PF	1.3.6.1.4.1.30966.6.X.1.5.2	Power factor of the phase three of device X
slave X Line Three Energy	1.3.6.1.4.1.30966.6.X.1.5.3	Energy of phase three of device X
slave X Line Three Current	1.3.6.1.4.1.30966.6.X.1.5.4	Current of phase three of device X
slave X Line Three Voltage	1.3.6.1.4.1.30966.6.X.1.5.5	voltage of phase three of device X
slave X Line Three Current Min	1.3.6.1.4.1.30966.6.X.1.5.6	Minimum Current of phase three of device X
slave X Line Three Current Max	1.3.6.1.4.1.30966.6.X.1.5.7	Maximum Current of phase three of device X
slave X Line Three Voltage Min	1.3.6.1.4.1.30966.6.X.1.5.8	Minimum voltage of phase three of device X
slave X Line Three Voltage Max	1.3.6.1.4.1.30966.6.X.1.5.9	Maximum voltage of phase three of device X
slave X Temp Hum	1.3.6.1.4.1.30966.6.X.1.6	The temperature and humidity of device X
slave X Temp One	1.3.6.1.4.1.30966.6.X.1.6.1	The temperature one of device X
slave X Temp Two	1.3.6.1.4.1.30966.6.X.1.6.2	The temperature two of device X
slave X Temp Three	1.3.6.1.4.1.30966.6.X.1.6.3	The temperature three of device X
slave X Temp Four	1.3.6.1.4.1.30966.6.X.1.6.4	The temperature four of device X
slave X Hum One	1.3.6.1.4.1.30966.6.X.1.6.5	The humidity one of device X
slave X Hum Two	1.3.6.1.4.1.30966.6.X.1.6.6	The humidity two of device X
slave X Hum Three	1.3.6.1.4.1.30966.6.X.1.6.7	The humidity three of device X

slave X Hum Four	1.3.6.1.4.1.30966.6.X.1.6.8	The humidity four of device X
slave X Door One	1.3.6.1.4.1.30966.6.X.1.6.9	The door one of device X
slave X Door Two	1.3.6.1.4.1.30966.6.X.1.6.10	The door two of device X
slave X Smoke	1.3.6.1.4.1.30966.6.X.1.6.11	The smoke of device X
slave X Water	1.3.6.1.4.1.30966.6.X.1.6.12	The water of device X
slave X Output Number	1.3.6.1.4.1.30966.6.X.1.7	The outlet quantity of device X
slave X Output Name	1.3.6.1.4.1.30966.6.X.1.8	The outlet name of device X
slave X Output Name One	1.3.6.1.4.1.30966.6.X.1.8.1	The name of outlet 1 of device X
slave X Output Name Two	1.3.6.1.4.1.30966.6.X.1.8.2	The name of outlet 2 of device X
slave X Output Name Three	1.3.6.1.4.1.30966.6.X.1.8.3	The name of outlet 3 of device X
slave X Output Name Four	1.3.6.1.4.1.30966.6.X.1.8.4	The name of outlet 4 of device X
slave X Output Name Five	1.3.6.1.4.1.30966.6.X.1.8.5	The name of outlet 5 of device X
slave X Output Name Six	1.3.6.1.4.1.30966.6.X.1.8.6	The name of outlet 6 of device X
slave X Output Name Seven	1.3.6.1.4.1.30966.6.X.1.8.7	The name of outlet 7 of device X
slave X Output Name Eight	1.3.6.1.4.1.30966.6.X.1.8.8	The name of outlet 8 of device X
slave X Output Name Nine	1.3.6.1.4.1.30966.6.X.1.8.9	The name of outlet 9 of device X
slave X Output Name Ten	1.3.6.1.4.1.30966.6.X.1.8.10	The name of outlet 10 of device X
slave X Output Name Eleven	1.3.6.1.4.1.30966.6.X.1.8.11	The name of outlet 11 of device X
slave X Output Name Twelve	1.3.6.1.4.1.30966.6.X.1.8.12	The name of outlet 12 of device X
slave X Output Name Thirteen	1.3.6.1.4.1.30966.6.X.1.8.13	The name of outlet 13 of device X
slave X Output Name Fourteen	1.3.6.1.4.1.30966.6.X.1.8.14	The name of outlet 14 of device X
slave X Output Name Fifteen	1.3.6.1.4.1.30966.6.X.1.8.15	The name of outlet 15 of device X
slave X Output Name Sixteen	1.3.6.1.4.1.30966.6.X.1.8.16	The name of outlet 16 of device X
slave X Output Name Seventeen	1.3.6.1.4.1.30966.6.X.1.8.17	The name of outlet 17 of device X
slave X Output Name Eighteen	1.3.6.1.4.1.30966.6.X.1.8.18	The name of outlet 18 of device X
slave X Output Name Nineteen	1.3.6.1.4.1.30966.6.X.1.8.19	The name of outlet 19 of device X
slave X Output Name Twenty	1.3.6.1.4.1.30966.6.X.1.8.20	The name of outlet 20 of device X
slave X Output Name Twenty One	1.3.6.1.4.1.30966.6.X.1.8.21	The name of outlet 21 of device X
slave X Output Name Twenty Two	1.3.6.1.4.1.30966.6.X.1.8.22	The name of outlet 22 of device X
slave X Output Name Twenty Three	1.3.6.1.4.1.30966.6.X.1.8.23	The name of outlet 23 of device X
slave X Output Name Twenty Four	1.3.6.1.4.1.30966.6.X.1.8.24	The name of outlet 24 of device X
slave X Output Status	1.3.6.1.4.1.30966.6.X.1.9	The outlet status of device X
slave X Output Status One	1.3.6.1.4.1.30966.6.X.1.9.1	The outlet 1 status of device X
slave X Output Status Two	1.3.6.1.4.1.30966.6.X.1.9.2	The outlet 2 status of device X
slave X Output Status Three	1.3.6.1.4.1.30966.6.X.1.9.3	The outlet 3 status of device X
slave X Output Status Four	1.3.6.1.4.1.30966.6.X.1.9.4	The outlet 4 status of device X
slave X Output Status Five	1.3.6.1.4.1.30966.6.X.1.9.5	The outlet 5 status of device X
slave X Output Status Six	1.3.6.1.4.1.30966.6.X.1.9.6	The outlet 6 status of device X
slave X Output Status Seven	1.3.6.1.4.1.30966.6.X.1.9.7	The outlet 7 status of device X
slave X Output Status Eight	1.3.6.1.4.1.30966.6.X.1.9.8	The outlet 8 status of device X
slave X Output Status Nine	1.3.6.1.4.1.30966.6.X.1.9.9	The outlet 9 status of device X
slave X Output Status Ten	1.3.6.1.4.1.30966.6.X.1.9.10	The outlet 10status of device X

slave X Output Status Eleven	1.3.6.1.4.1.30966.6.X.1.9.11	The outlet 11 status of device X
slave X Output Status Twelve	1.3.6.1.4.1.30966.6.X.1.9.12	The outlet 12 status of device X
slave X Output Status Thirteen	1.3.6.1.4.1.30966.6.X.1.9.13	The outlet 13 status of device X
slave X Output Status Fourteen	1.3.6.1.4.1.30966.6.X.1.9.14	The outlet 14 status of device X
slave X Output Status Fifteen	1.3.6.1.4.1.30966.6.X.1.9.15	The outlet 15 status of device X
slave X Output Status Sixteen	1.3.6.1.4.1.30966.6.X.1.9.16	The outlet 16 status of device X
slave X Output Status Seventeen	1.3.6.1.4.1.30966.6.X.1.9.17	The outlet 17 status of device X
slave X Output Status Eighteen	1.3.6.1.4.1.30966.6.X.1.9.18	The outlet 18 status of device X
slave X Output Status Nineteen	1.3.6.1.4.1.30966.6.X.1.9.19	The outlet 19 status of device X
slave X Output Status Twenty	1.3.6.1.4.1.30966.6.X.1.9.20	The outlet 20 status of device X
slave X Output Status Twenty One	1.3.6.1.4.1.30966.6.X.1.9.21	The outlet 21 status of device X
slave X Output Status Twenty Two	1.3.6.1.4.1.30966.6.X.1.9.22	The outlet 22 status of device X
slave X Output Status Twenty Three	1.3.6.1.4.1.30966.6.X.1.9.23	The outlet 23 status of device X
slave X Output Current	1.3.6.1.4.1.30966.6.X.1.10	The outlet current of device X
slave X Output Current One	1.3.6.1.4.1.30966.6.X.1.10.1	The current of outlet 1 of device X
slave X Output Current Two	1.3.6.1.4.1.30966.6.X.1.10.2	The current of outlet 2 of device X
slave X Output Current Three	1.3.6.1.4.1.30966.6.X.1.10.3	The current of outlet 3 of device X
slave X Output Current Four	1.3.6.1.4.1.30966.6.X.1.10.4	The current of outlet 4 of device X
slave X Output Current Five	1.3.6.1.4.1.30966.6.X.1.10.5	The current of outlet 5 of device X
slave X Output Current Six	1.3.6.1.4.1.30966.6.X.1.10.6	The current of outlet 6 of device X
slave X Output Current Seven	1.3.6.1.4.1.30966.6.X.1.10.7	The current of outlet 7 of device X
slave X Output Current Eight	1.3.6.1.4.1.30966.6.X.1.10.8	The current of outlet 8 of device X
slave X Output Current Nine	1.3.6.1.4.1.30966.6.X.1.10.9	The current of outlet 9 of device X
slave X Output Current Ten	1.3.6.1.4.1.30966.6.X.1.10.10	The current of outlet 10 of device X
slave X Output Current Eleven	1.3.6.1.4.1.30966.6.X.1.10.11	The current of outlet 11 of device X
slave X Output Current Twelve	1.3.6.1.4.1.30966.6.X.1.10.12	The current of outlet 12 of device X
slave X Output Current Thirteen	1.3.6.1.4.1.30966.6.X.1.10.13	The current of outlet 13 of device X
slave X Output Current Fourteen	1.3.6.1.4.1.30966.6.X.1.10.14	The current of outlet 14 of device X
slave X Output Current Fifteen	1.3.6.1.4.1.30966.6.X.1.10.15	The current of outlet 15 of device X
slave X Output Current Sixteen	1.3.6.1.4.1.30966.6.X.1.10.16	The current of outlet 16 of device X
slave X Output Current Seventeen	1.3.6.1.4.1.30966.6.X.1.10.17	The current of outlet 17 of device X
slave X Output Current Eighteen	1.3.6.1.4.1.30966.6.X.1.10.18	The current of outlet 18 of device X
slave X Output Current Nineteen	1.3.6.1.4.1.30966.6.X.1.10.19	The current of outlet 19 of device X

slave X Output Current Twenty	1.3.6.1.4.1.30966.6.X.1.10.20	The current of outlet 20 of device X
slave X Output Current Twenty One	1.3.6.1.4.1.30966.6.X.1.10.21	The current of outlet 21 of device X
slave X Output Current Twenty Two	1.3.6.1.4.1.30966.6.X.1.10.22	The current of outlet 22 of device X
slave X Output Current Twenty Three	1.3.6.1.4.1.30966.6.X.1.10.23	The current of outlet 23 of device X
slave X Output Current Twenty Four	1.3.6.1.4.1.30966.6.X.1.10.24	The current of outlet 24 of device X
slave X Output Current Min	1.3.6.1.4.1.30966.6.X.1.11	The outlet Minimum current of device X
slave X Output Current Min One	1.3.6.1.4.1.30966.6.X.1.11.1	The Minimum current of outlet 1 of device X
slave X Output Current Min Two	1.3.6.1.4.1.30966.6.X.1.11.2	The Minimum current of outlet 2 of device X
slave X Output Current Min Three	1.3.6.1.4.1.30966.6.X.1.11.3	The Minimum current of outlet 3 of device X
slave X Output Current Min Four	1.3.6.1.4.1.30966.6.X.1.11.4	The Minimum current of outlet 4 of device X
slave X Output Current Min Five	1.3.6.1.4.1.30966.6.X.1.11.5	The Minimum current of outlet 5 of device X
slave X Output Current Min Six	1.3.6.1.4.1.30966.6.X.1.11.6	The Minimum current of outlet 6 of device X
slave X Output Current Min Seven	1.3.6.1.4.1.30966.6.X.1.11.7	The Minimum current of outlet 7 of device X
slave X Output Current Min Eight	1.3.6.1.4.1.30966.6.X.1.11.8	The Minimum current of outlet 8 of device X
slave X Output Current Min Nine	1.3.6.1.4.1.30966.6.X.1.11.9	The Minimum current of outlet 9 of device X
slave X Output Current Min Ten	1.3.6.1.4.1.30966.6.X.1.11.10	The Minimum current of outlet 10 of device X
slave X Output Current Min Eleven	1.3.6.1.4.1.30966.6.X.1.11.11	The Minimum current of outlet 11 of device X
slave X Output Current Min Twelve	1.3.6.1.4.1.30966.6.X.1.11.12	The Minimum current of outlet 12 of device X
slave X Output Current Min Thirteen	1.3.6.1.4.1.30966.6.X.1.11.13	The Minimum current of outlet 13 of device X
slave X Output Current Min Fourteen	1.3.6.1.4.1.30966.6.X.1.11.14	The Minimum current of outlet 14 of device X
slave X Output Current Min Fifteen	1.3.6.1.4.1.30966.6.X.1.11.15	The Minimum current of outlet 15 of device X
slave X Output Current Min Sixteen	1.3.6.1.4.1.30966.6.X.1.11.16	The Minimum current of outlet 16 of device X

slave X Output Current Min Seventeen	1.3.6.1.4.1.30966.6.X.1.11.17	The Minimum current of outlet 17 of device X
slave X Output Current Min Eighteen	1.3.6.1.4.1.30966.6.X.1.11.18	The Minimum current of outlet 18 of device X
slave X Output Current Min Nineteen	1.3.6.1.4.1.30966.6.X.1.11.19	The Minimum current of outlet 19 of device X
slave X Output Current Min Twenty	1.3.6.1.4.1.30966.6.X.1.11.20	The Minimum current of outlet 20 of device X
slave X Output Current Min Twenty One	1.3.6.1.4.1.30966.6.X.1.11.21	The Minimum current of outlet 21 of device X
slave X Output Current Min Twenty Two	1.3.6.1.4.1.30966.6.X.1.11.22	The Minimum current of outlet 22 of device X
slave X Output Current Min Twenty Three	1.3.6.1.4.1.30966.6.X.1.11.23	The Minimum current of outlet 23 of device X
slave X Output Current Min Twenty Four	1.3.6.1.4.1.30966.6.X.1.11.24	The Minimum current of outlet 24 of device X
slave X Output Current Max	1.3.6.1.4.1.30966.6.X.1.12	The Minimum outlet current of device X
slave X Output Current Max One	1.3.6.1.4.1.30966.6.X.1.12.1	The Maximum current of outlet 1 of device X
slave X Output Current Max Two	1.3.6.1.4.1.30966.6.X.1.12.2	The Maximum current of outlet 2 of device X
slave X Output Current Max Three	1.3.6.1.4.1.30966.6.X.1.12.3	The Maximum current of outlet 3 of device X
slave X Output Current Max Four	1.3.6.1.4.1.30966.6.X.1.12.4	The Maximum current of outlet 4 of device X
slave X Output Current Max Five	1.3.6.1.4.1.30966.6.X.1.12.5	The Maximum current of outlet 5 of device X
slave X Output Current Max Six	1.3.6.1.4.1.30966.6.X.1.12.6	The Maximum current of outlet 6 of device X
slave X Output Current Max Seven	1.3.6.1.4.1.30966.6.X.1.12.7	The Maximum current of outlet 7 of device X
slave X Output Current Max Eight	1.3.6.1.4.1.30966.6.X.1.12.8	The Maximum current of outlet 8 of device X
slave X Output Current Max Nine	1.3.6.1.4.1.30966.6.X.1.12.9	The Maximum current of outlet 9 of device X
slave X Output Current Max Ten	1.3.6.1.4.1.30966.6.X.1.12.10	The Maximum current of outlet 10 of device X
slave X Output Current Max Eleven	1.3.6.1.4.1.30966.6.X.1.12.11	The Maximum current of outlet 11 of device X
slave X Output Current Max Twelve	1.3.6.1.4.1.30966.6.X.1.12.12	The Maximum current of outlet 12 of device X
slave X Output Current Max Thirteen	1.3.6.1.4.1.30966.6.X.1.12.13	The Maximum current of outlet 13 of device X

slave X Output Current Max Fourteen	1.3.6.1.4.1.30966.6.X.1.12.14	The Maximum current of outlet 14 of device X
slave X Output Current Max Fifteen	1.3.6.1.4.1.30966.6.X.1.12.15	The Maximum current of outlet 15 of device X
slave X Output Current Max Sixteen	1.3.6.1.4.1.30966.6.X.1.12.16	The Maximum current of outlet 16 of device X
slave X Output Current Max Seventeen	1.3.6.1.4.1.30966.6.X.1.12.17	The Maximum current of outlet 17 of device X
slave X Output Current Max Eighteen	1.3.6.1.4.1.30966.6.X.1.12.18	The Maximum current of outlet 18 of device X
slave X Output Current Max Nineteen	1.3.6.1.4.1.30966.6.X.1.12.19	The Maximum current of outlet 19 of device X
slave X Output Current Max Twenty	1.3.6.1.4.1.30966.6.X.1.12.20	The Maximum current of outlet 20 of device X
slave X Output Current Max Twenty One	1.3.6.1.4.1.30966.6.X.1.12.21	The Maximum current of outlet 21 of device X
slave X Output Current Max Twenty Two	1.3.6.1.4.1.30966.6.X.1.12.22	The Maximum current of outlet 22 of device X
slave X Output Current Max Twenty Three	1.3.6.1.4.1.30966.6.X.1.12.23	The Maximum current of outlet 23 of device X
slave X Output Current Max Twenty Four	1.3.6.1.4.1.30966.6.X.1.12.24	The Maximum current of outlet 24 of device X
slave X Output Current Energy	1.3.6.1.4.1.30966.6.X.1.13	The energy of device X
slave X Output Current Energy One	1.3.6.1.4.1.30966.6.X.1.13.1	The energy of outlet 1 of device X
slave X Output Current Energy Two	1.3.6.1.4.1.30966.6.X.1.13.2	The energy of outlet 2 of device X
slave X Output Current Energy Three	1.3.6.1.4.1.30966.6.X.1.13.3	The energy of outlet 3 of device X
slave X Output Current Energy Four	1.3.6.1.4.1.30966.6.X.1.13.4	The energy of outlet 4 of device X
slave X Output Current Energy Five	1.3.6.1.4.1.30966.6.X.1.13.5	The energy of outlet 5 of device X
slave X Output Current Energy Six	1.3.6.1.4.1.30966.6.X.1.13.6	The energy of outlet 6 of device X
slave X Output Current Energy Seven	1.3.6.1.4.1.30966.6.X.1.13.7	The energy of outlet 7 of device X
slave X Output Current Energy Eight	1.3.6.1.4.1.30966.6.X.1.13.8	The energy of outlet 8 of device X
slave X Output Current Energy Nine	1.3.6.1.4.1.30966.6.X.1.13.9	The energy of outlet 9 of device X
slave X Output Current Energy Ten	1.3.6.1.4.1.30966.6.X.1.13.10	The energy of outlet 10 of device X
slave X Output Current Energy Eleven	1.3.6.1.4.1.30966.6.X.1.13.11	The energy of outlet 11 of device X
slave X Output Current Energy Twelve	1.3.6.1.4.1.30966.6.X.1.13.12	The energy of outlet 12 of device X
slave X Output Current Energy Thirteen	1.3.6.1.4.1.30966.6.X.1.13.13	The energy of outlet 13 of device X
slave X Output Current Energy Fourteen	1.3.6.1.4.1.30966.6.X.1.13.14	The energy of outlet 14 of device X
slave X Output Current Energy Fifteen	1.3.6.1.4.1.30966.6.X.1.13.15	The energy of outlet 15 of device X
slave X Output Current Energy Sixteen	1.3.6.1.4.1.30966.6.X.1.13.16	The energy of outlet 16 of device X
slave X Output Current Energy Seventeen	1.3.6.1.4.1.30966.6.X.1.13.17	The energy of outlet 17 of device X
slave X Output Current Energy Eighteen	1.3.6.1.4.1.30966.6.X.1.13.18	The energy of outlet 18 of device X
slave X Output Current Energy Nineteen	1.3.6.1.4.1.30966.6.X.1.13.19	The energy of outlet 19 of device X
slave X Output Current Energy Twenty	1.3.6.1.4.1.30966.6.X.1.13.20	The energy of outlet 20 of device X

slave X Output Current Energy Twenty One	1.3.6.1.4.1.30966.6.X.1.13.21	The energy of outlet 21 of device X
slave X Output Current Energy Twenty Two	1.3.6.1.4.1.30966.6.X.1.13.22	The energy of outlet 22 of device X
slave X Output Current Energy Twenty Three	1.3.6.1.4.1.30966.6.X.1.13.23	The energy of outlet 23 of device X
slave X Output Current Energy Twenty Four	1.3.6.1.4.1.30966.6.X.1.13.24	The energy of outlet 24 of device X

B. To view the device and sensor status by table format via SNMP software:

Table 2-1 The outlet statue information table

Menu	Description
SMART PDU Device xx	Device xx
Slave xx line xx	Phase xx of device xx
Slave xx line xx Power	Power of phase xx of device xx
Slave xx line xx PF	Power Factor of phase xx of device xx
Slave xx line xx Energy	Energy of phase xx of device xx
Slave xx line xx Current	Current of phase xx of device xx
Slave xx line xx Voltage	Voltage of phase xx of device xx
Slave xx line xx Current MIN	The Minimum current of phase xx of device xx
Slave xx line xx Current Max	The Maximum current of phase xx of device xx
Slave xx line xx Voltage Min	The Minimum voltage of phase xx of device xx
Slave xx line xx Voltage Max	The Maximum voltage of phase xx of device xx
Slave xx temp	The temperature of device xx
Slave xx hum	The humidity of device xx
Slave xx temp Min	The Minimum temperature value of device xx
Slave xx temp Max	The Maximum temperature value of device xx
Slave xx hum Min	The Minimum humidity value of device xx
Slave xx hum Max	The Maximum humidity value of device xx
Slave xx output name xx	The outlet name of outlet xx of device xx
Slave xx output status xx	The on/off status of outlet xx of device xx
Slave xx output current xx	The current of outlet xx of device xx
Slave xx output current Min xx	The Minimum current of outlet xx of device xx
Slave xx output current Max xx	The Maximum current of outlet xx of device
Slave xx output current Energy xx	The energy of outlet xx of device xx



Slave xx name	The name of device xx
Slave xx Type	The type of device xx
Slave xx output number	The outlet quantity of device xx

### 3.2.3 Telnet Access

The device supports Telnet access, after enter the username and password, user can remotely monitor and management the device. Telnet access support daisy-chain as well to enable the user to manage up to 5 devices.

**3.2.3.1. To open the Telnet client**  by Start→ Run command→enter “Telnet” in the input box and click OK

**3.2.3.2. Enter the IP address as illustrated in figure 2-4**

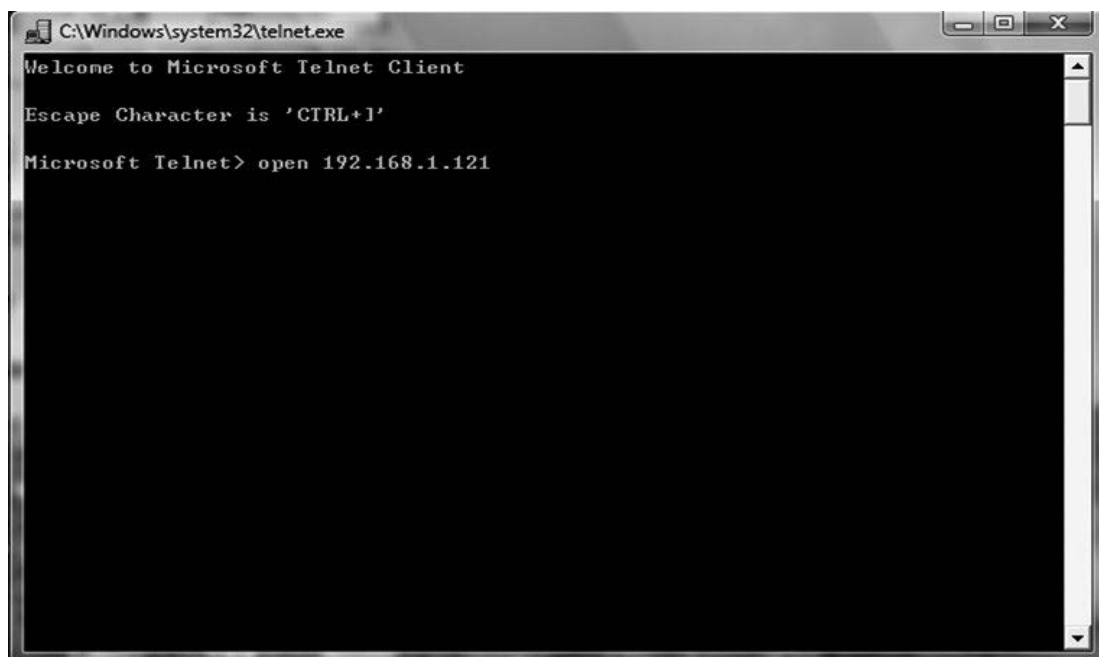

Figure 2-4

Enter the username and password, interface as shown in figure 2-5 will pop up

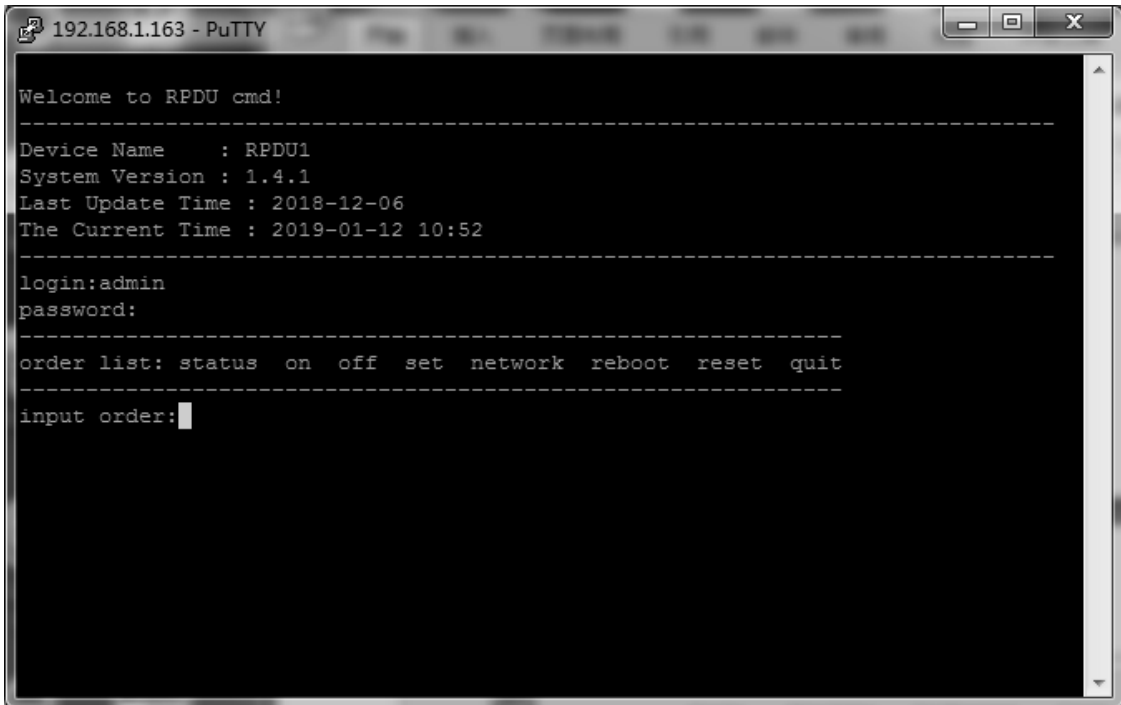

Figure 2-5

### 3.2.3.3 “STATUS” command

Input “STATUS” command to view the individual outlet status (including current, on/off state, Max. and Min. current value, kW and kWh) and the overall status (including total current, voltage, kW and kWh).

Command line format: STATUS **【index】【operation】** as illustrated in figure 2-6:

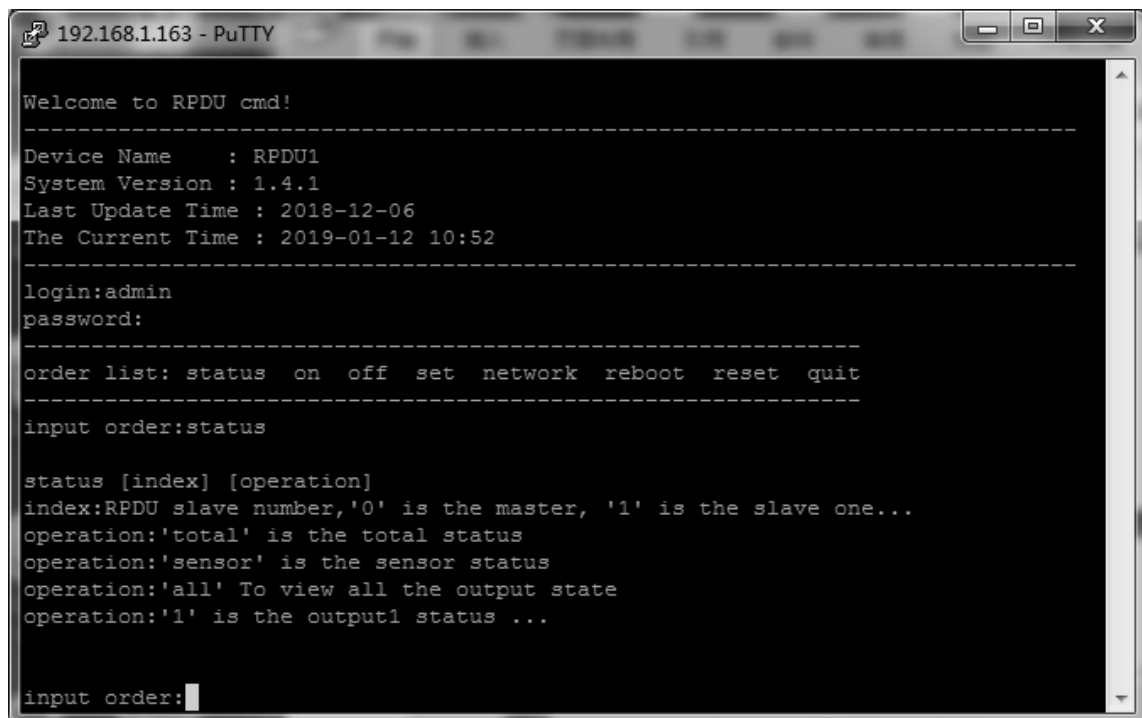
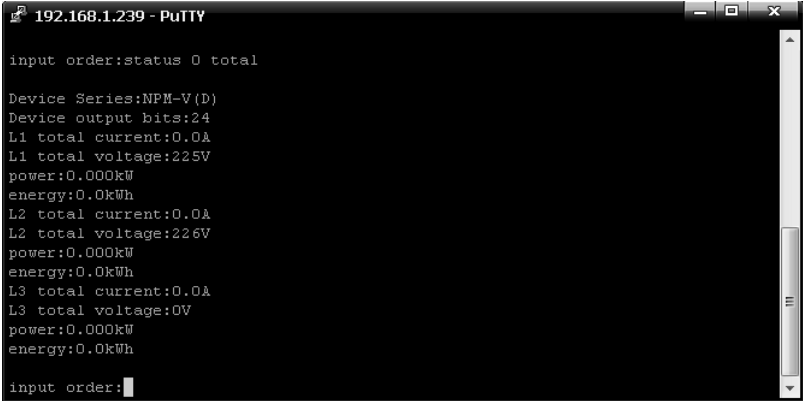
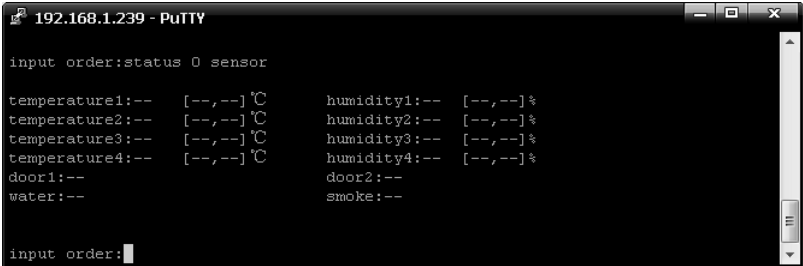
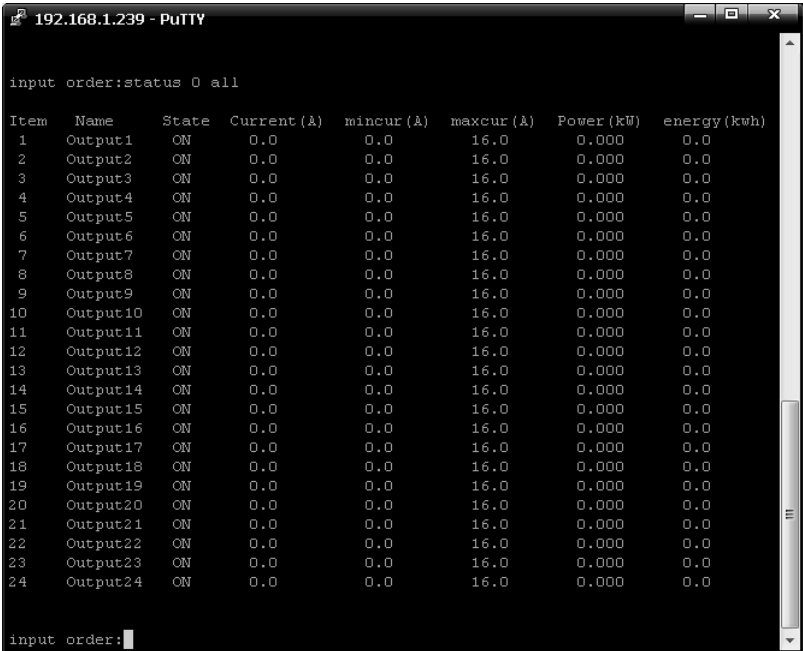
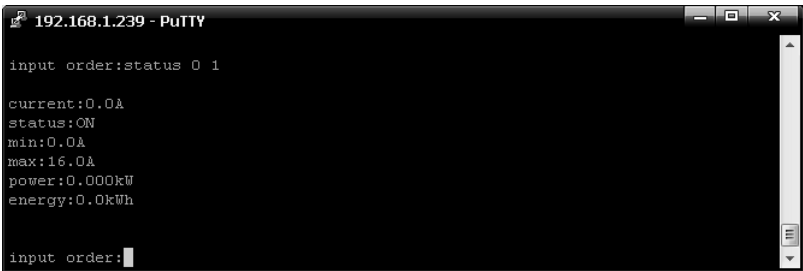

Figure 2-6

【index】 : device mode (0-9, 0 is master, 1-4 is slave) ;

【operation】 : view the device information, details as below:

【operation】	Description
Total	<p>For example:</p>  <p>Enter command line---<b>status 0 total</b>: 0 means the Master (1-4 means Slave 1 to Slave 4), total means the overall status, the above figure shown after input “status 0 total”. The return information will be as picture above</p>
sensor	 <p>Enter command line---<b>status 0 sensor</b>: 0 means the Master unit; 1-4 means the Slave units. The return information will be as picture above</p>

<p style="text-align: center;">all</p>	 <pre> input order:status 0 all  Item  Name      State  Current (A)  mincur (A)  maxcur (A)  Power (kW)  energy (kwh) 1     Output1    ON     0.0          0.0         16.0        0.000      0.0 2     Output2    ON     0.0          0.0         16.0        0.000      0.0 3     Output3    ON     0.0          0.0         16.0        0.000      0.0 4     Output4    ON     0.0          0.0         16.0        0.000      0.0 5     Output5    ON     0.0          0.0         16.0        0.000      0.0 6     Output6    ON     0.0          0.0         16.0        0.000      0.0 7     Output7    ON     0.0          0.0         16.0        0.000      0.0 8     Output8    ON     0.0          0.0         16.0        0.000      0.0 9     Output9    ON     0.0          0.0         16.0        0.000      0.0 10    Output10   ON     0.0          0.0         16.0        0.000      0.0 11    Output11   ON     0.0          0.0         16.0        0.000      0.0 12    Output12   ON     0.0          0.0         16.0        0.000      0.0 13    Output13   ON     0.0          0.0         16.0        0.000      0.0 14    Output14   ON     0.0          0.0         16.0        0.000      0.0 15    Output15   ON     0.0          0.0         16.0        0.000      0.0 16    Output16   ON     0.0          0.0         16.0        0.000      0.0 17    Output17   ON     0.0          0.0         16.0        0.000      0.0 18    Output18   ON     0.0          0.0         16.0        0.000      0.0 19    Output19   ON     0.0          0.0         16.0        0.000      0.0 20    Output20   ON     0.0          0.0         16.0        0.000      0.0 21    Output21   ON     0.0          0.0         16.0        0.000      0.0 22    Output22   ON     0.0          0.0         16.0        0.000      0.0 23    Output23   ON     0.0          0.0         16.0        0.000      0.0 24    Output24   ON     0.0          0.0         16.0        0.000      0.0  input order: </pre> <p>Enter command line---<b>status 0 all</b>, 0 means the Master unit; 1-4 means the Slave units. The return information will be as picture above</p>
<p style="text-align: center;">Output</p>	<p>For example</p>  <pre> input order:status 0 1  current:0.0A status:ON min:0.0A max:16.0A power:0.000kW energy:0.0kWh  input order: </pre> <p>command line---<b>status 0 1</b>: 0 means the Master(1-4 means Slave 1 to Slave 4), 1 means the status of first outlet, the above figure will be displayed after input “status 0 1”</p>

### 3.2.3.4“ON/OFF” command

“ON/OFF” command enable the user to switch on/off the individual outlet or the complete device  
Command format: ON/OFF 【index】 【operation】 as shown in figure 2-7

```

192.168.1.239 - PuTTY
input order:?
-----
order list: status on off set network reboot reset quit
-----

input order:on

on [index] [operation]
index:RPDU slave number,'0' is the master, '1' is the slave one...
operation:'all' is the total switch
operation:'1' is the output1 switch ...

input order:

```

Figure 2-7

**【index】** :device mode ( 0-9, 0 is master, 1-4 is slave ) ;

**【operation】** :view the device information, details as below:

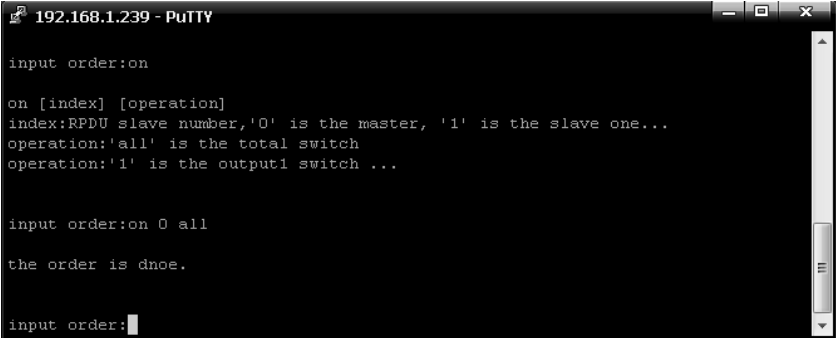
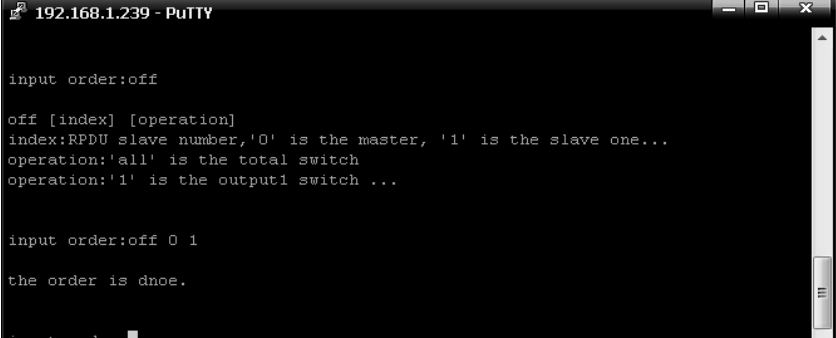
【operation】	Description
ALL	 <p>Command line---<b>on 0 all</b> means to switch on all outlet from the Master unit</p>
Output	 <p>Command line---<b>off 0 1</b> on means to switch off the first outlet of the Master unit</p>

### 3.2.3.5 Set command:

“set” command enable to Set the current of outlet , temperature and humidity minimum and maximum threshold, changing the IP, mask, gateway, dns , dns1;

Command format: set **【index】【operation】** as shown in figure 2-8

```

192.168.1.239 - PuTTY
input order:set

set [index] [operation]...
index:RPDU slave number,'0' is the master, '1' is the slave one...
set 0 output1 xx
operation:'output1' is a name you want to change the output ...
set 0 temp1 min=xx max=xx
operation:'temp1' is the temperature1 threshold settings ...
set 0 hum1 min=xx max=xx
operation:'hum1' is the humidity1 threshold settings ...
set 0 current1 min=xx max=xx
operation:'current1' is the output1 current threshold setting ...
set 0 Tcurrent1 Tmin=xx Tmax=xx
operation:'Tcurrent1' is the Total Load(L1) threshold setting ...
set ip=xxx.xxx.xxx.xxx
set mask=xxx.xxx.xxx.xxx
set gateway=xxx.xxx.xxx.xxx
set dns=xxx.xxx.xxx.xxx
set dns1=xxx.xxx.xxx.xxx

input order:
  
```

Figure 2-8

**【index】** : device mode (0-9, 0 is master, 1-4 is slave);

**【operation】** : view the device information, details as below:

<b>【operation】</b>	<b>Description</b>
output	<pre> 192.168.1.239 - PuTTY input order:set  set [index] [operation]... index:RPDU slave number,'0' is the master, '1' is the slave one... set 0 output1 xx operation:'output1' is a name you want to change the output ... set 0 temp1 min=xx max=xx operation:'temp1' is the temperature1 threshold settings ... set 0 hum1 min=xx max=xx operation:'hum1' is the humidity1 threshold settings ... set 0 current1 min=xx max=xx operation:'current1' is the output1 current threshold setting ... set 0 Tcurrent1 Tmin=xx Tmax=xx operation:'Tcurrent1' is the Total Load(L1) threshold setting ... set ip=xxx.xxx.xxx.xxx set mask=xxx.xxx.xxx.xxx set gateway=xxx.xxx.xxx.xxx set dns=xxx.xxx.xxx.xxx set dns1=xxx.xxx.xxx.xxx  input order:set 0 output1 a1  input order:   </pre> <p>Command line---<b>set 0 output1 a1</b> means rename the output 1 as a1</p>

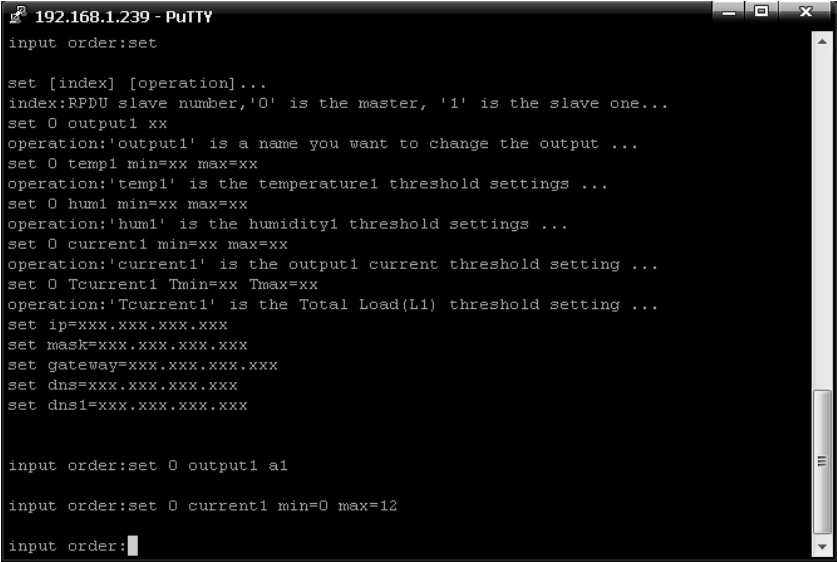
<p>current</p>	 <pre> 192.168.1.239 - PuTTY input order:set  set [index] [operation]... index:RPDU slave number,'0' is the master, '1' is the slave one... set 0 output1 xx operation:'output1' is a name you want to change the output ... set 0 temp1 min=xx max=xx operation:'temp1' is the temperature1 threshold settings ... set 0 hum1 min=xx max=xx operation:'hum1' is the humidity1 threshold settings ... set 0 current1 min=xx max=xx operation:'current1' is the output1 current threshold setting ... set 0 Tcurrent1 Tmin=xx Tmax=xx operation:'Tcurrent1' is the Total Load(L1) threshold setting ... set ip=xxx.xxx.xxx.xxx set mask=xxx.xxx.xxx.xxx set gateway=xxx.xxx.xxx.xxx set dns=xxx.xxx.xxx.xxx set dns1=xxx.xxx.xxx.xxx  input order:set 0 output1 a1  input order:set 0 current1 min=0 max=12  input order: </pre> <p>Command line--- <b>set 0 current1 min=0 max=12</b> means set up the minimum current as 0 and maximum current as 12 for output 1 from Master unit</p>
----------------	---

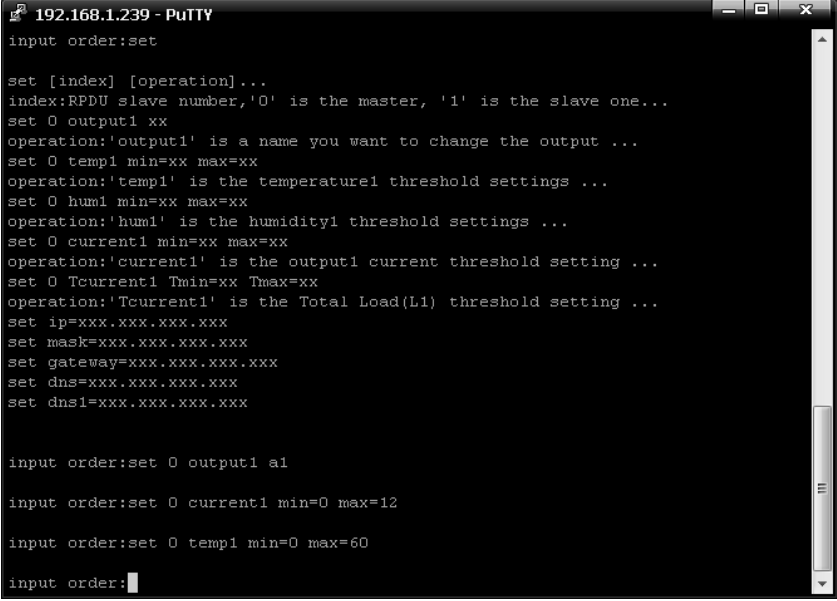
<p>temperature</p>	 <pre> 192.168.1.239 - PuTTY input order:set  set [index] [operation]... index:RPDU slave number,'0' is the master, '1' is the slave one... set 0 output1 xx operation:'output1' is a name you want to change the output ... set 0 temp1 min=xx max=xx operation:'temp1' is the temperature1 threshold settings ... set 0 hum1 min=xx max=xx operation:'hum1' is the humidity1 threshold settings ... set 0 current1 min=xx max=xx operation:'current1' is the output1 current threshold setting ... set 0 Tcurrent1 Tmin=xx Tmax=xx operation:'Tcurrent1' is the Total Load(L1) threshold setting ... set ip=xxx.xxx.xxx.xxx set mask=xxx.xxx.xxx.xxx set gateway=xxx.xxx.xxx.xxx set dns=xxx.xxx.xxx.xxx set dns1=xxx.xxx.xxx.xxx  input order:set 0 output1 a1  input order:set 0 current1 min=0 max=12  input order:set 0 temp1 min=0 max=60  input order: </pre> <p>Command line--- <b>set 0 temp1 min=0 max=60</b> means set the minimum temperature as 0 degree and maximum temperature 60 degree for temperature sensor 1 from master unit</p>
--------------------	---

humidity

```
192.168.1.239 - PuTTY
input order:set

set [index] [operation]...
index:RPDU slave number,'0' is the master, '1' is the slave one...
set 0 output1 xx
operation:'output1' is a name you want to change the output ...
set 0 temp1 min=xx max=xx
operation:'temp1' is the temperature1 threshold settings ...
set 0 hum1 min=xx max=xx
operation:'hum1' is the humidity1 threshold settings ...
set 0 current1 min=xx max=xx
operation:'current1' is the output1 current threshold setting ...
set 0 Tcurrent1 Tmin=xx Tmax=xx
operation:'Tcurrent1' is the Total Load(L1) threshold setting ...
set ip=xxx.xxx.xxx.xxx
set mask=xxx.xxx.xxx.xxx
set gateway=xxx.xxx.xxx.xxx
set dns=xxx.xxx.xxx.xxx
set dns1=xxx.xxx.xxx.xxx

input order:set 0 output1 a1

input order:set 0 temp1 min=0 max=60

input order:set 0 hum1 min=0 max=90

input order:set 0 current1 min=0 max=12

input order:set 0 Tcurrent1 Tmin=0 Tmax=16

input order:
```

Command line---**set 0 hum1 min=0 max=90** means set the minimum humidity as 0% and maximum humidity as 90% for humidity sensor 1 from Master unit

Tcurrent

```
192.168.1.239 - PuTTY
input order:set

set [index] [operation]...
index:RPDU slave number,'0' is the master, '1' is the slave one...
set 0 output1 xx
operation:'output1' is a name you want to change the output ...
set 0 temp1 min=xx max=xx
operation:'temp1' is the temperature1 threshold settings ...
set 0 hum1 min=xx max=xx
operation:'hum1' is the humidity1 threshold settings ...
set 0 current1 min=xx max=xx
operation:'current1' is the output1 current threshold setting ...
set 0 Tcurrent1 Tmin=xx Tmax=xx
operation:'Tcurrent1' is the Total Load(L1) threshold setting ...
set ip=xxx.xxx.xxx.xxx
set mask=xxx.xxx.xxx.xxx
set gateway=xxx.xxx.xxx.xxx
set dns=xxx.xxx.xxx.xxx
set dns1=xxx.xxx.xxx.xxx

input order:set 0 output1 a1

input order:set 0 temp1 min=0 max=60

input order:set 0 hum1 min=0 max=90

input order:set 0 current1 min=0 max=12

input order:set 0 Tcurrent1 Tmin=0 Tmax=16

input order:
```

Command line---**set 0 Tcurrent1 Tmin=0 Tmax=16** means set the minimum current as 0A and maximum current as 16A for total current of phase A from Master unit

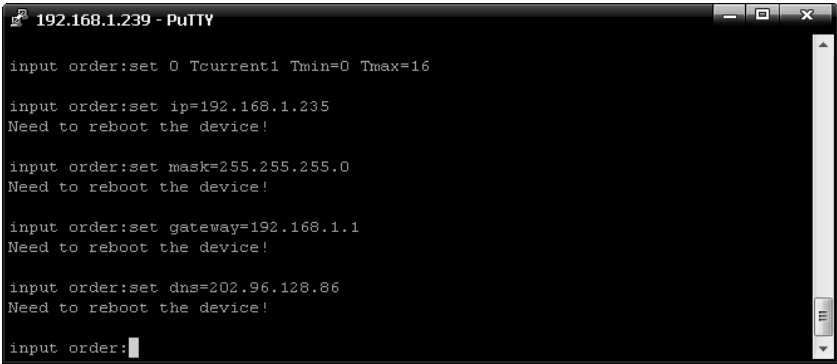

network	 <p>Command line---<b>set 0 ip=192.168.1.223</b> Means to configure Master network IP address as 192.168.1.223</p>
---------	--

3.2.3.6 Network command: Check network configuration information, such as IP address, subnet mask, default gateway, main DNS, spare DNS.

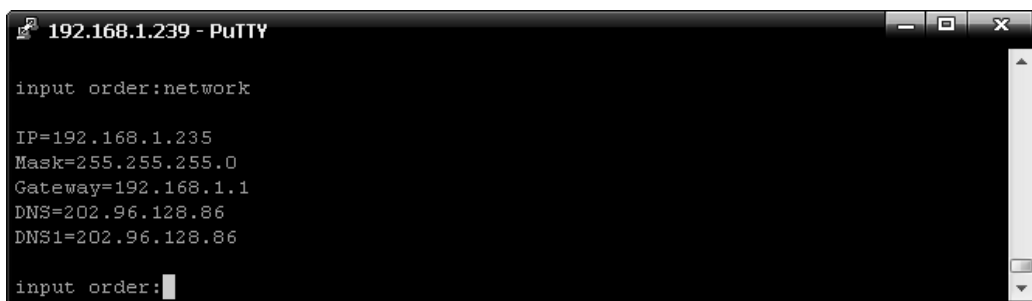

Figure 2-9

3.2.3.7 Reboot command: to restart to device as shown in figure 2-10

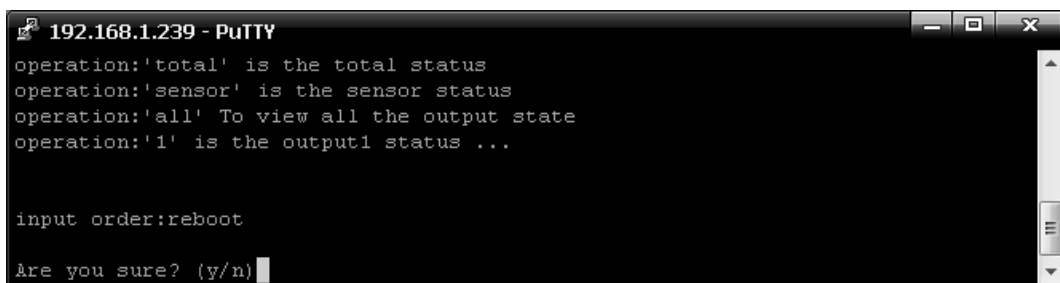

Figure 2-10

After type Y and press Enter, exit the telnet interface, and restart device system;  
Type n and press Enter to exit the telnet interface

### 3.2.3.8: RESET command to restore to factory settings as figure 2-11



```
192.168.1.239 - PuTTY
input order:reset
Restore to default setting !
Are you sure? (y/n)
```

Figure 2-11

### 3.2.3.9: QUIT command to quit the telnet client as shown in figure 2-12



```
192.168.1.239 - PuTTY
input order:reset
Restore to default setting !
Are you sure? (y/n)

input order:quit
Are you sure? (y/n) n
```

Figure 2-12

Type y and press Enter to quit the Telnet interface. Type n and press Enter to cancel the operation.

## 3.2.4 MODBUS Access

Please refer to the 《SMART PDU MODBUS RTU Protocol Instruction》 for the MODBUS access

# 4. Frequently Asked Questions

## 4.1. Forget IP address?

A: check on the LCD screen, the first page displays the IP address.

## 4.2. Fail to send email?

- A: 1) Check and confirm the device connected to network and the network works normally.  
2) Check DNS configuration and confirm whether it is successful.  
3) Check and confirm POP, SMTP sever is correct and the same as the sender mailbox sever.  
Please confirm SMTP port is correct.

## 4.3. Lost IP

A. Press and hold the RESET button for 6 seconds, Release the RESET button when the device buzz, the device will restart.

## 5. Technology Parameters

No.	Performance parameter		Technical parameter
1	Input	Rated input voltage	110/220VAC 50/60 Hz; 380 VAC 50/60 Hz;
		Rated input plug	IEC60309 standard
		Cable specification	16A:3×2.5mm <sup>2</sup> 32A:3×6.0mm <sup>2</sup> ; 3×16A:5×2.5mm <sup>2</sup> 3×32A:5×6.0mm <sup>2</sup>
		Cable length	2.5M
		Max. load current	16A, 32A 3×16A, 3×32A
		Overload protector	1P circuit breaker 3P circuit breaker
2	Output	Socket standard	Standard IEC320 C13, C19
		Socket quantity	A Series: 8, 16, 24, 36way; B Series: 8, 16, 24way; C Series: 8, 16, 24way; D Series: 8, 16, 24way;
		Output voltage	110/220VAC 50/60 Hz
		Output current	16A, 32A 3*16A,3*32A
3	Control ports	Net port	1×RJ45 port
		Daisy chain port	2×RJ45 port
		Software update port	1×RJ45 port
		Temperature & humidity port	Max 2×RJ11 port (can add more)
		Smoke sensor port	Max 1×RJ11 port (optional)
		Water sensor port	Max 1×RJ11 port (optional)
		Door sensor port	Max 1×RJ11 port (optional)
4	Display	Working state	1×LED
		Power pulse	1×LED
		IP Address, M/S SMART PDU state, measurement value, alarm state	LCD screen (Resolution: 128×64)
5	Load current display	Total current	Full-scale:16A/32A,Accuracy:±1%+0.2 Resolution:200mA, Response:400ms

	technology requirement	Individual load current	Full-scale: 10A/ 16A, Accuracy:±1%+0.1, resolution:100mA, Response:400ms
6	Temperature /humidity Technology requirement	Temperature	Accuracy:±1°C, Response: 400ms
		Humidity	Accuracy:±5%RH, Response: 400ms
7	Product size	Product size (L×W×H)	X <sup>2</sup> ×56×52mm
		Mounting hole	X <sup>3</sup>
8	Case color	Color	Black
9	Fittings	Installation bracket	1 set
		Network connection cable	2M blue network cable*1
		Daisy-chain connection cable	2M yellow network cable*1
		Serial connection cable	2M Ivory Serial cable*1
		User manual	1 set (CD)
10	Optional fittings	Sensor	Temperature/humidity sensor
			Smoke sensor
			Door sensor
			Water logging sensor
11	Environment	Working Environment	Temperature: 0°C~+45°C Relative humidity: 30%~90%
		Storage Environment	Temperature: -20°C~+70°C Relative humidity :0%~95%
12	ROHS	Compliance	

This is a Class A product. In home environment, this product may cause radio interference.

In this case, the user may be required to take appropriate measures.

Hereby Assmann Electronic GmbH, declares that the Declaration of Conformity is part of the shipping content.

If the Declaration of Conformity is missing, you can request it by post under the below mentioned manufacturer address.

**www.assmann.com**

Assmann Electronic GmbH  
Auf dem Schüffel 3  
58513 Lüdenscheid  
Germany





**Smart PDU, Eingangsüberwachung,  
1-phasig, 32 A, 20 x C13, 4 x C19**



**Handbuch**  
DN-95631

# Content

1. Smart PDU Introduction.....	3
1.1. Function Description .....	3
1.2 Application range.....	5
1.3 Product picture and description.....	6
1.4 Installation .....	7
2. Hardware Introduction.....	7
2.1. System initialization.....	7
2.2. View system information.....	7
2.3.Overload Monitoring .....	111
2.4. Environment monitoring .....	11
2.5. PDU reset.....	11
2.6. Display backlight always-on configuration .....	11
2.7. Reverse the display.....	11
2.8. Restore to factory settings.....	12
2.9. Master or Slave configuration .....	12
2.10. Daisy-Chain .....	12
3. SMART PDU Software Introduction .....	143
3.1. Software overview.....	143
3.2. Access method .....	143
3.2.1 Web access .....	143
3.2.2 SNMP Access.....	417
3.2.3 Telnet Access.....	495
3.2.4. MODBUS Access .....	<b>Error! Bookmark not defined.</b> 4
4. Frequently Asked Questions .....	584
4.1. Forget IP address?.....	584
4.2. Fail to send email? .....	584
4.3. Lost IP.....	584
5. Technology Parameters .....	<b>Error! Bookmark not defined.</b> 5

## Sicherheit und Erdung:

**Lesen Sie die folgenden Informationen, bevor Sie Ihre DIGITUS Power Distribution Unit installieren oder betreiben:**

- Diese PDU ist nur für die Verwendung in Innenräumen vorgesehen.
- Diese PDU darf nicht hintereinander betrieben werden!
- Betrieb nur in trockenen und geschlossenen Räumen.
- Diese PDU darf nicht abgedeckt betrieben werden. Sorgen Sie immer für freie Zugänglichkeit.
- Die auf dem Typenschild angegebene maximale Leistung darf nicht überschritten werden.
- Schließen Sie diese PDU nur an eine dreipolige, geerdete Steckdose an. Die Steckdose muss mit einem geeigneten Abzweigstromkreis/Netzschutz (Sicherung oder Schutzschalter) verbunden sein. Der Anschluss an eine andere Art von Steckdose kann zu einem Stromschlag führen.
- Verwenden Sie nur die mitgelieferten Halterungen zur Befestigung.
- Prüfen Sie, ob das Netzkabel, der Netzstecker und die Steckdose in einwandfreiem Zustand sind.
- Das Gerät ist nur dann spannungsfrei, wenn der Netzstecker gezogen ist.
- Trennen Sie die PDU von der Steckdose, bevor Sie Geräte installieren oder anschließen, um die Gefahr eines Stromschlags zu verringern, wenn Sie die Erdung nicht überprüfen können. Schließen Sie die PDU erst wieder an die Steckdose an, nachdem Sie alle Anschlüsse vorgenommen haben.
- Der Betrieb unter ungünstigen Umgebungsbedingungen muss vermieden werden. (Luftfeuchtigkeit über 80 % relativ, Nässe, Umgebungstemperaturen über 50°C, Lösungsmittel, brennbare Gase, Staub, Dämpfe).
- Wenn äußere Schäden an dieser PDU festgestellt werden, darf diese PDU nicht betrieben werden. Nehmen Sie diese PDU sofort außer Betrieb, wenn eine äußere Beschädigung festgestellt wird.
- Schütten Sie keine Flüssigkeiten über die Steckdosenleiste. Es besteht ein hohes Risiko eines Brandes oder eines lebensgefährlichen Stromschlags.
- Beim Öffnen der Steckdosenleiste können stromführende Teile freigelegt werden. Es besteht die Gefahr eines elektrischen Schlages. Die Steckdosenleiste darf nur von einer Fachkraft geöffnet werden.

## 1. Smart PDU Einführung

Die Smart Power Distribution Unit ist ein über das Netzwerk verwaltbares Gerät, das die Stromüberwachung, -steuerung und -verwaltung für viele Geräte im Rack-Schrank eines Rechenzentrums auf der ganzen Welt über LAN oder WAN ermöglicht. Um den Einschränkungen und Anforderungen in verschiedenen Umgebungen gerecht zu werden, bietet die SMART PDU viele Verbindungsmethoden, die der Benutzer über die Web-Schnittstelle (HTTP oder HTTPS), die serielle Verbindung, Telnet oder SNMP verwalten kann.

### 1.1. Funktionsbeschreibung

1. Überwachungsfunktion: Überwachen Sie den Strom, die Spannung, die Leistung (kW) und den Energieverbrauch (kWh), den Umgebungsstatus wie Temperatur, Feuchtigkeit, Rauch, Tür und Wasserleckage über IP und lokalen LCD-Bildschirm.
2. Steuerungsfunktion: Schalten Sie einzelne Steckdosen ein/aus, stellen Sie das Intervall des sequenziellen Ein-/Ausschaltens ein
3. Beibehaltung des früheren Zustands: Beibehaltung des früheren Zustands jedes Ausgangs nach

dem Zurücksetzen.

4. Benutzerdefinierter Alarm: Benutzer kann den Schwellenwert von Strom, Temperatur und Feuchtigkeit einstellen.
5. Systemstandardalarm: Sie erhalten eine Warnung, wenn der Gesamtnennstrom, der individuelle Nennstrom (ohne A&C-Serie) überschritten wird; wenn Rauch, Wasser oder eine offene Tür erkannt wurde.
6. Alarmmethoden: Die Alarminformationen werden auf dem LCD-Bildschirm angezeigt und der Summer der SMART PDU ertönt. Der Problemwert blinkt auf der Weboberfläche und der PC-Summer-Alarm sendet automatisch eine E-Mail an den Systemadministrator; SNMP sendet Trap-Warnungen.
7. Daisy-Chain: schlägt Daisy-Chain von maximal 5 Einheiten vor (Master-Einheit eingeschlossen)
8. Benutzerverwaltung: Benutzerrechte konfigurierbar. Neu hinzugefügte Benutzer können in verschiedene Benutzergruppen mit unterschiedlichen Rechten aufgeteilt werden. Benutzergruppenrechte sind editierbar.
9. Zugriffsmethode: Web-Schnittstelle, HTTP, HTTPS, SNMP (v1 / v2c / v3), Telnet und serielle Konsole.
10. Unterstützung Mehrbenutzer-Betriebssystem und Software-Update.

Es gibt vier Serienfreigaben für die Smart PDU-Reihe.

A, B, C, D Funktionsvergleichstabelle:

	A-Serie	B-Serie	C-Serie	D-Serie
Messung auf Eingangsebene (A/V/VA/kWh/Leistungsfaktor)	Ja	Ja	Ja	Ja
Einzelne Ausgangsmessung	Nein	Ja	Nein	Ja
Einzelne Steckdose schalten	Nein	Nein	Ja	Ja

A-Serie: DN-95624/ DN-95625

B-Serie: DN-95628/ DN-95629

C-Serie: DN-95630/ DN-95631

D-Serie: DN-95632/ DN-95633/ DN-95634

Nummer	Funktion	Beschreibung & Reichweite
1	Überwachung	Überwachungsfunktion: Über den lokalen LCD-Bildschirm kann der Benutzer den Gesamtstrom und den Strom jeder einzelnen Steckdose (A&C-Serie nicht inbegriffen), den Ein/Aus-Status jeder einzelnen Steckdose (A&B-Serie nicht inbegriffen), den Umgebungsstatus wie Temperatur/ Luftfeuchtigkeit/ Rauch/ Wasserprotokollierung und Tür



2	Steuerung	Steuerungsfunktion (A&B-Serie nicht enthalten): Ein-/Ausschalten jedes einzelnen Ausgangs, Einrichten der Ein-/Ausschaltverzögerung, Rückkehr zum Nullpunkt für den gesamten oder individuellen Stromverbrauch, Konfigurieren des Zeitplanereignisses, Stromabschaltungseinstellungen bei Überlast, schnelles Einrichten von Massen-PDUs und Back-up sowie WIFI-Einstellungen.
3	Beibehalten des alten Zustands	Beibehalten des früheren Status (A&B-Serie nicht enthalten): Beibehalten des früheren Zustands jedes Ausgangs nach dem Neustart
4	Benutzerdefinierter Alarm	Benutzerdefinierter Alarm: wenn Schwellenwerte für Gesamtstrom, Einzelstrom (A&C-Serie nicht enthalten), Temperatur und Feuchtigkeit überschritten werden
5	System-Standardalarm	System-Standardalarm: wenn der Gesamtnennstrom, der individuelle Nennstrom (A&C-Serie nicht enthalten) überschritten wird; wenn Rauch, Wasser oder eine offene Tür erkannt wurde

## 1.2 Anwendungsbereich

1. SMART PDU kann in Serverracks, Netzwerkschränken usw. eingesetzt werden.
2. Ausgangstyp und -anzahl (8, 16 und 24) können entsprechend den tatsächlichen Bedürfnissen ausgewählt werden.
3. Erfüllt RoHS-Richtlinie, anwendbar für 110~220VAC, 380VAC Stromversorgung, kann die Anforderungen der Kunden auf der ganzen Welt erfüllen.

## 1.3 Produktbild und Beschreibung

### 1.3.1 Vertikale SMART PDU (0U)

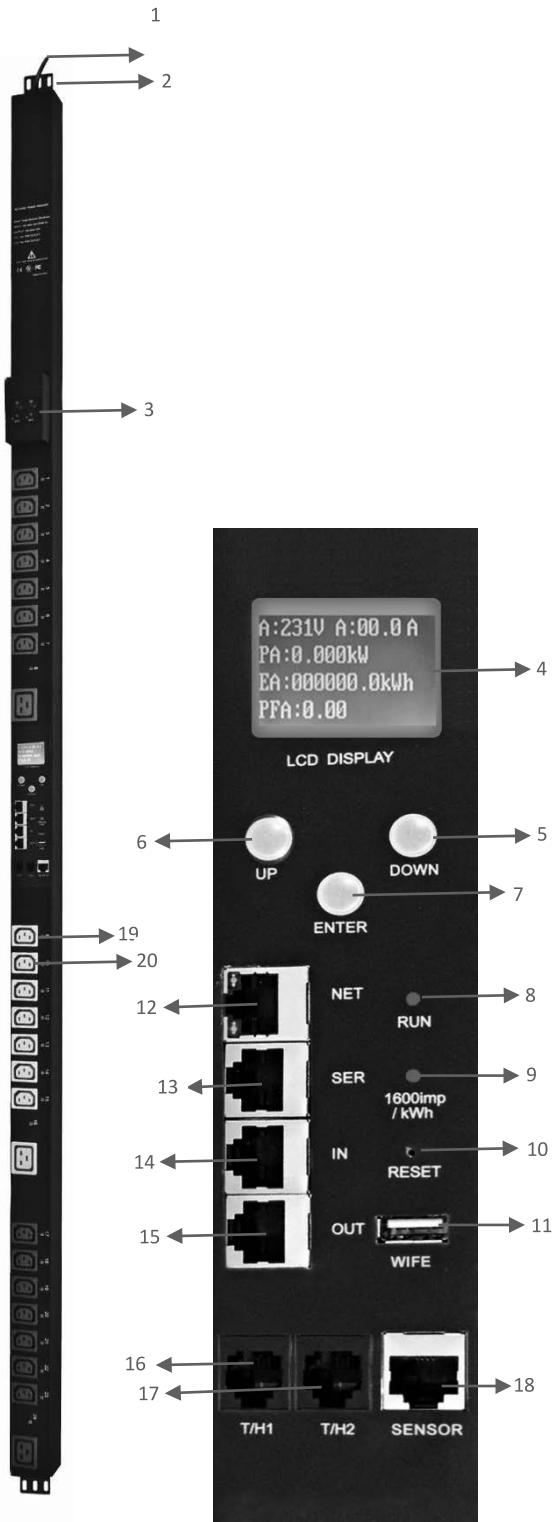

1. Eingangsnetz kabel;
2. Halterungen;
3. Hydraulischer Schutzschalter;
4. LCD-Bildschirm;
5. AB-Taste: Blättern zur nächsten Seite;
6. UP-Taste: Aufwärtsblättern zur vorherigen Seite;
7. ENTER: OK-Taste;
8. RUN-Anzeige
9. 1600imp/kWh Energieimpuls-Anzeige;
10. RESET-Taste;
11. USB-Anschluss für WIFI-Zugang oder Software-Upgrade;
12. NET: 10/100M-Ethernet-Kommunikationsanschluss
13. SER: Serieller Kommunikationsanschluss
14. (unterstützt MODBUS);
15. IN: für Daisy-Chain
16. OUT: für Daisy-Chain
17. T/H1: Temperatur- und Feuchtesensoranschluss 1
18. T/H1: Temperatur- und Luftfeuchtigkeitssensor Port 2
19. SENSOR: Erweiterung des Sensor-Hub-Kommunikationsanschlusses, Sensor-Hub unterstützt 2 Temperatur-/Luftfeuchtigkeitssensor, 2 Türsensoren, 1 Sensor zur Wasseraufzeichnung und 1 Rauchsensor
20. LED-Anzeige;
21. Ausgänge

## 1.4 Installation

Vertikale Montage (0U)

## 2. Hardware-Einführung

### 2.1. System-Initialisierung

Der Summer ertönt beim Einschalten der SMART PDU und stoppt nach 3 Sekunden. Dann leuchtet der LCD-Bildschirm nach 6 Sekunden auf und es werden folgende Informationen angezeigt:

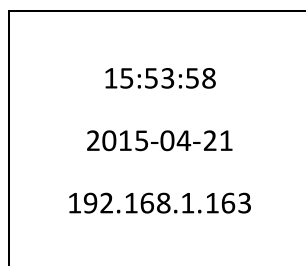

Vertical (0U)

(Device time)  
(Date)  
(IP address)

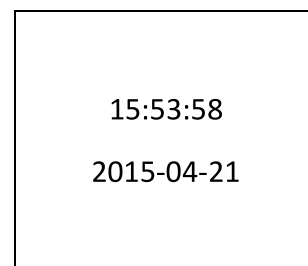

Horizontal (1U)

**Hinweis: 192.168.1.163 ist die Standard-IP-Adresse; und dies ist die erste Seite nach der Systeminitialisierung.**

### 2.2. Systeminformationen anzeigen

#### 2.2.1. Systeminformationen anzeigen (0U)

Drücken Sie **ENTER**, um zum Hauptmenü zu gelangen

(Die erste Seite im Menü)

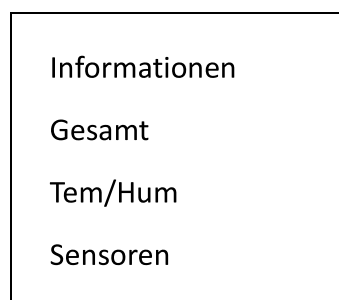

(Geräteinformationen)  
(Gesamtleistungsdaten)  
(Temperatur/Luftfeuchtigkeit)  
(Tür/Wasser)

(Die zweite Seite im Menü)

Ausgang	(Ausgangssteckdose)
Gruppe	(Steckdosengruppe)

Blättern Sie mit der Taste DOWN oder UP zur nächsten/vorherigen Seite, gehen Sie zum Hauptmenü und wählen Sie den ersten Punkt **Information** aus, drücken Sie dann **ENTER**, um zum Informationsmenü zu gelangen; die angezeigten Informationen sind wie unten dargestellt:

CPU: ARM926EJ-S	(CPU-Modell)
Version: 1.0.0	(Software-Version)
M/S: Master	(Master/Slave-Gerät)
Typ: 3 Phasen D	(Geräteserie)

**Hinweis: Die angezeigten Informationen können von der Geräte-Teilenummer abweichen.**

CPU: ARM926EJ-S bedeutet den Typ des Geräte-CPU-Chips; Version: 1.0.0 ist die Software-Versionsnummer; M/S: Master bedeutet die Master-Einheit und Slave 1 bedeutet die Slave-Einheit 1(1-4 bedeutet die Reihenfolge der Slave-Einheit); Typ: 3 Phase C bedeutet, dass es sich um ein Gerät der 3-Phasen-C-Serie handelt.

Blättern Sie mit den Tasten **DOWN** oder UP zur nächsten/vorherigen Seite, gehen Sie zum Hauptmenü und wählen Sie den zweiten Punkt **Total**, drücken Sie dann **ENTER**, um zum Total-Menü zu gelangen, und die angezeigten Informationen sind wie unten:

U: 214V I: 00.0A
P: 0.000kW
E: 000013.1kWh
PF: 0.00

Hinweis: Die obigen Informationen beziehen sich auf ein einphasiges Gerät; wenn es sich um ein dreiphasiges Gerät handelt, werden auch die Leistungsdaten jeder Phase angezeigt. U: 214V bedeutet die Eingangsspannung, I:00.0A bedeutet den gesamten Eingangsstrom, P:0.000KW bedeutet die Gesamtleistung, E:000013.1kWh bedeutet den gesamten Stromverbrauch, PF:0.00

bedeutet den Leistungsfaktor

Drücken Sie **ENTER**, um zum Hauptmenü zurückzukehren, und drücken Sie dann die Taste **DOWN**, um Temp/Hum auszuwählen und die **Temperatur/Luftfeuchtigkeit** wie unten dargestellt anzuzeigen:

T1: ---	H1: ---
T2: ---	H2: ---
T3: ---	H3: ---
T4: ---	H4: ---

Drücken Sie **ENTER**, um zum Hauptmenü zurückzukehren, und drücken Sie dann die **DOWN-Taste**, um **Sensoren** auszuwählen und den Status der Tür-, Wasseraufzeichnungs- und Rauchsensoren wie unten dargestellt anzuzeigen:

Tür1: Keine
Tür2: Keine
Rauchen: Keine
Wasser: Keine

Drücken Sie die Taste **ENTER**, um zum Hauptmenü zurückzukehren, und drücken Sie dann die Taste **DOWN**, um "**Output**" (Ausgang) auszuwählen, um den Strom jedes einzelnen Ausgangs wie unten dargestellt anzuzeigen:

Ausgang01: 00.0A
Ausgang02: 00.0A
Ausgang03: 00.0A
Ausgang04: 00.0A

Drücken Sie die Taste **DOWN** oder **UP**, um den Strom der Restausgänge anzuzeigen:

**Hinweis: Drücken Sie die Taste UP, um die vorherige Seite der Geräteinformationen anzuzeigen.**

Drücken Sie die Taste **ENTER**, um zum Hauptmenü zurückzukehren, und drücken Sie dann die Taste **DOWN**, um die **Gruppe** auszuwählen, um den Strom der einzelnen Gruppenausgänge wie unten dargestellt anzuzeigen:

Gruppe1: 00.0A	Gruppe5: 00.0A
Gruppe2: 00.0A	Gruppe6: 00.0A
Gruppe3: 00.0A	
Gruppe4: 00.0A	

### 2.2.2. Systeminformationen anzeigen (1U)

Blättern Sie mit den Tasten **DOWN** oder UP zur nächsten/vorherigen Seite, gehen Sie zum Hauptmenü und wählen Sie den ersten Punkt Information, dann drücken Sie **ENTER**, um zum Informationsmenü zu gelangen; die angezeigten Informationen sind wie unten:

Typ: SMART-PDU (D)	(Geräteserie)
192.168.1.163	(IP-Adresse)
Version: 1.0.0	(Software-Version)
M/S: Master	(Master/Slave-Gerät)

**Hinweis: Die angezeigten Informationen können von der Geräte-Teilenummer abweichen.**

Typ: SMART PDU (D) bedeutet, dass das Gerät Desires ist; 192.168.1.163 ist die IP-Adresse, Version: 1.0.0 ist die Software-Versionsnummer; M/S: Master bedeutet die Master-Einheit und Slave 1 bedeutet die Slave-Einheit 1 (1-4 bedeutet die Reihenfolge der Slave-Einheit); Drücken Sie die DOWN- oder UP-Taste, um zur nächsten/vorherigen Seite zu blättern, gehen Sie zum Hauptmenü und wählen Sie den zweiten Punkt **Total**, dann drücken Sie DOWM, um zum Total-Menü zu gelangen, und die angezeigten Informationen sind wie unten:

U: 214V I: 00.0A
P: 0.000kW
E: 000013.1kWh
PF: 0.00

**Hinweis: Die obigen Informationen beziehen sich auf ein einphasiges Gerät; wenn es sich um ein dreiphasiges Gerät handelt, wird auch das Leistungsdatum jeder Phase angezeigt.**

U: 214V bedeutet die Eingangsspannung, I: 00.0A bedeutet den gesamten Eingangsstrom, P: 0.000KW bedeutet die Gesamtleistung, E: 000013.1kWh bedeutet den gesamten Stromverbrauch, PF: 0.00 bedeutet den Leistungsfaktor;  
Drücken Sie die **DOWN**-Taste, um **Temp/Hum** auszuwählen, um die Temperatur/Luftfeuchtigkeit wie unten dargestellt anzuzeigen:

T1: ---	H1: ---
T2: ---	H2: ---
T3: ---	H3: ---
T4: ---	H4: ---

Drücken Sie die **DOWN**-Taste, um "**Output**" (Ausgang) auszuwählen, um jeden einzelnen Ausgangsstrom wie unten dargestellt anzuzeigen:

Ausgang 1: 00.0A	Ausgang 5: 00.0A
Ausgang 2: 00.0A	Ausgang 6: 00.0A
Ausgang 3: 00.0A	Ausgang 7: 00.0A
Ausgang 4: 00.0A	Ausgang 8: 00.0A

**Hinweis: Drücken Sie die Taste UP, um die vorherige Seite der Geräteinformationen anzuzeigen.**

## 2.3. Überlast-Überwachung

2.3.1. Wenn der Strom eines einzelnen Ausgangs den benutzerdefinierten Wert überschreitet, ertönt der Summer der SMART PDU; der LCD-Bildschirm leuchtet auf und schaltet automatisch auf die Alarmseite und der Stromwert blinkt.

2.3.2. Wenn der Gesamtstrom den benutzerdefinierten Wert überschreitet, ertönt der Summer der SMART PDU; der LCD-Bildschirm leuchtet auf und schaltet automatisch auf die Alarmseite um und der aktuelle Wert blinkt

## 2.4. Überwachung der Umgebung

Wenn der Schwellenwert der Temperatur oder Luftfeuchtigkeit überschritten wird, ertönt der Summer der SMART PDU, der LCD-Bildschirm leuchtet auf und schaltet automatisch auf die Alarmseite um. Der aktuelle Temperatur- oder Luftfeuchtigkeitswert blinkt.

## 2.5. Zurücksetzen der PDU

Halten Sie die AUF-Taste 6 Sekunden lang gedrückt, um einen Reset durchzuführen.

**Hinweis: Die Konfiguration der Ein-/Ausschaltverzögerung muss nach dem Zurücksetzen erneut vorgenommen werden.**

## 2.6. Konfiguration der Display-Hintergrundbeleuchtung "Always-on"

Drücken und halten Sie die DOWN-Taste für ca. 2 Sekunden, der Summer ertönt und der Bildschirm leuchtet immer, drücken und halten Sie die DOWN-Taste für weitere 2 Sekunden, der Bildschirm kehrt in den Normalmodus zurück

## 2.7. Umkehrung der Anzeige

Drücken Sie die AUF-Taste zweimal schnell, um den angezeigten Text umzukehren. (Horizontal keine Rollover-Funktion.)

## 2.8. Zurücksetzen auf Werkseinstellungen

Halten Sie die Reset-Taste 6 Sekunden lang gedrückt und lassen Sie sie los, bis der Signalton ertönt, um die Werkseinstellungen wiederherzustellen.

## 2.9. Master- oder Slave-Konfiguration

So konfigurieren Sie die SMART-PDU als Master oder Slave in der Webschnittstelle. Der aktuelle Master- oder Slave-Status wird auf der LCD-Startseite angezeigt, "M/S: Master" bedeutet Master, und "M/S: Slave1" bedeutet Slave 1



## 2.10. Daisy-Chain

Das Daisy-Chain-Schema ist wie folgt:

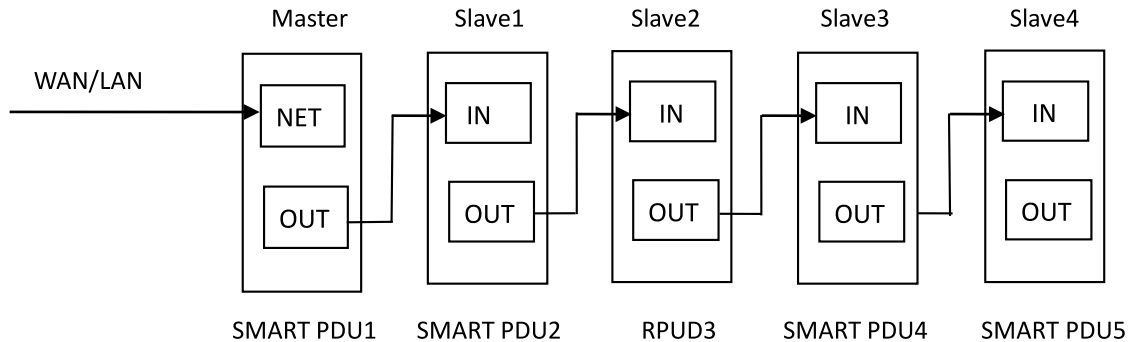

So wird die Verkettung durchgeführt

2.10.1. Melden Sie sich bei jeder SMART-PDU an; konfigurieren Sie den Arbeitsmodus auf der Seite "Device Manage" (Geräteverwaltung).

2.10.2. Verketteten Sie alle Geräte wie in der obigen Zeichnung, von OUT nach IN, maximal 5 Geräte inklusive Master.

2.10.3. Greifen Sie auf den Master zu und überprüfen Sie den Status aller Slaves. Wenn alle lesbar sind, ist die Verkettung erfolgreich.

Bemerkung:

1. Wenn das System normal läuft, wird ca. 10s später der LCD-Bildschirm normal angezeigt.
2. Gerät sequentiell einschalten, Intervallzeit zum Ausschalten ca. 30s. Schalten Sie das Gerät nicht häufig ein/aus, um Schäden am Gerät zu vermeiden.

## 3. SMART PDU Software-Einführung

### 3.1. Software-Übersicht

Die SMART PDU ist mit einem eingebetteten Softwaresystem ausgestattet, das eine Vielzahl von Netzwerkdiensten wie WEB-Server, SNMP, Telnet, SMTP und NTP bietet. Es ist einfach, zweite Entwicklung und Software-Integration zu tun.

### 3.2. Zugriffsverfahren

Webbasiert, kann über Browser wie Internet Explorer, Google Chrome und Firefox zugreifen; unterstützt WIFI (einschließlich mobiler Geräte wie Smartphone und Tablet), SNMP (v1 / v2c / v3), Telnet und serielle Konsole wie MODBUS.

#### 3.2.1 Web access

Öffnen Sie einen Browser und geben Sie die Standard-IP-Adresse ein; das Anmeldefenster erscheint wie unten, siehe Abbildung 1-1.

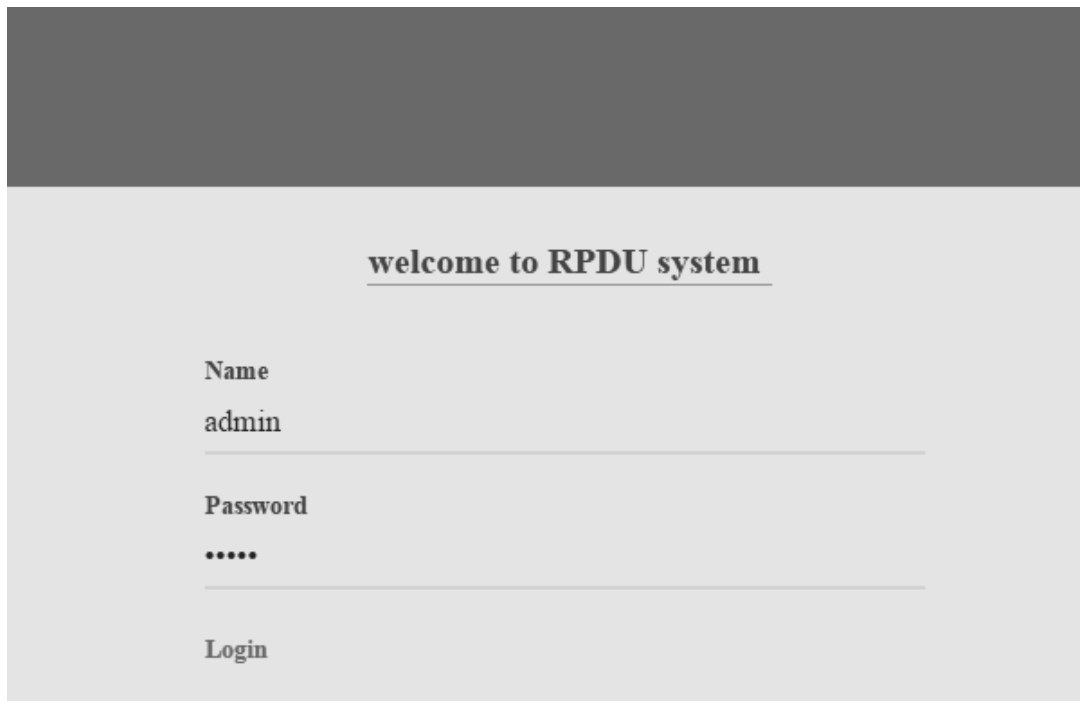

**welcome to RPDU system**

Name  
admin

Password  
\*\*\*\*\*

Login

Abbildung 1-1

Geben Sie den richtigen Benutzernamen und das richtige Passwort ein (**der werkseitig voreingestellte Login-Name ist admin, das Passwort ist admin**), um sich an der Hauptschnittstelle anzumelden, siehe Abbildung 1-2

The screenshot shows the RPDUI web interface. At the top right, there is a language selection menu with 'English' and '中文' options. Below this is a navigation menu with tabs for 'Overview', 'Device Settings', 'User Management', 'Network', 'Data Graphing', 'Logs', and 'System'. The main content area is divided into three sections: 'Device Information', 'Output Status', and 'Environment Status'. The 'Device Information' section on the left shows details for 'RPDU1', including its name, series, working status, and monitoring level. The 'Output Status' section in the center features a table with 24 rows, each representing an output. The 'Environment Status' section on the right shows overall device metrics like total load, voltage, power factor, and energy consumption. A dropdown menu at the top right of the table allows selecting a specific device (currently 'RPDU1').

Item	Name	State	Current(A)	Power(kW)	Power Factor	Critical
1	Output1	ON	0.0	0.000	0.00	Normal
2	Output2	ON	0.0	0.000	0.00	Normal
3	Output3	ON	0.0	0.000	0.00	Normal
4	Output4	ON	0.0	0.000	0.00	Normal
5	Output5	ON	0.0	0.000	0.00	Normal
6	Output6	ON	0.0	0.000	0.00	Normal
7	Output7	ON	0.0	0.000	0.00	Normal
8	Output8	ON	0.0	0.000	0.00	Normal
9	Output9	ON	0.0	0.000	0.00	Normal
10	Output10	ON	0.0	0.000	0.00	Normal
11	Output11	ON	0.0	0.000	0.00	Normal
12	Output12	ON	0.0	0.000	0.00	Normal
13	Output13	OFF	0.0	0.000	0.00	Normal
14	Output14	OFF	0.0	0.000	0.00	Normal
15	Output15	OFF	0.0	0.000	0.00	Normal
16	Output16	OFF	0.0	0.000	0.00	Normal
17	Output17	OFF	0.0	0.000	0.00	Normal
18	Output18	OFF	0.0	0.000	0.00	Normal
19	Output19	OFF	0.0	0.000	0.00	Normal
20	Output20	OFF	0.0	0.000	0.00	Normal
21	Output21	OFF	0.0	0.000	0.00	Normal
22	Output22	OFF	0.0	0.000	0.00	Normal
23	Output23	OFF	0.0	0.000	0.00	Normal
24	Output24	OFF	0.0	0.000	0.00	Normal

Abbildung 1-2

Hauptsächlich 3 Teile auf der Hauptschnittstelle: Navigationsmenü, Geräteinformationen und Ausgangsstatus.

Navigationsmenü: Anzeige des Firmenlogos und der Funktionsmenüs sowie der Sprachauswahl.

Geräteinformationen: Anzeige des Gerätenamens, der Geräteserie, des Gerätestatus und der Funktionsebene.

Ausgangsstatus: Anzeige von Ausgangsname, Ein/Aus-Zustand, individuellem Strom, individueller Leistung, Leistungsfaktor und Umgebungsstatus. Im Dropdown-Menü des Geräts können Sie die Informationen der Slaves überprüfen.

### 3.2.1.1 Geräteinformationen

Zu den **Geräteinformationen** gehören Gerätenamen, Geräteserie, Gerätestatus und Funktionsebene.

Der Ausgangsstatus umfasst Gesamtlast, Spannung, Leistungsfaktor, Gesamtleistung (kW) und Gesamtenergieverbrauch (kWh).

### 3.2.1.2. Geräteverwaltung: Klicken Sie im Menü auf Geräteverwaltung, um die Grundkonfiguration des Geräts vorzunehmen, wie in Abbildung 1-3 dargestellt

#### A. Grundeinstellungen

- a. **Einstellung des Arbeitsmodus:** Stellen Sie das Gerät im Dropdown-Menü als Master oder Slave (1-4) ein und speichern Sie.

- b. **Einstellung des Gerätenamens:** Benennen Sie die Geräte neu und speichern Sie.
- c. **Einheitsstromverzögerung:** Aktivieren oder deaktivieren Sie die Einheitsstromverzögerung. Wenn die Einheitsstromverzögerung aktiviert ist, schaltet sich die Steckdose entsprechend dem eingestellten Einheitsintervall (Bereich von 0 bis 15) nacheinander ein oder aus. Wenn die einheitliche Ein-/Ausschaltverzögerung deaktiviert wurde, schaltet sich der Ausgang entsprechend der individuellen internen Einstellung sequentiell ein/aus (siehe die Funktion "Outlet Settings" auf Seite 12, Abbildung 1-3-2).
- d. **Moduseinstellung:** Konfigurieren des Summerstatus, Aktivieren oder Deaktivieren des Gruppenausgangs, Aktivieren oder Deaktivieren des immer leuchtenden LCD-Bildschirms



Abbildung 1-3

B. Einstellung des Gruppenausgangs: Wenn der Gruppenausgang in den Grundeinstellungen aktiviert ist, kann der Benutzer jeden Ausgang nach dem Zufallsprinzip in 6 verschiedenen Gruppen abhaken und den Vorgang nach der Konfiguration speichern.

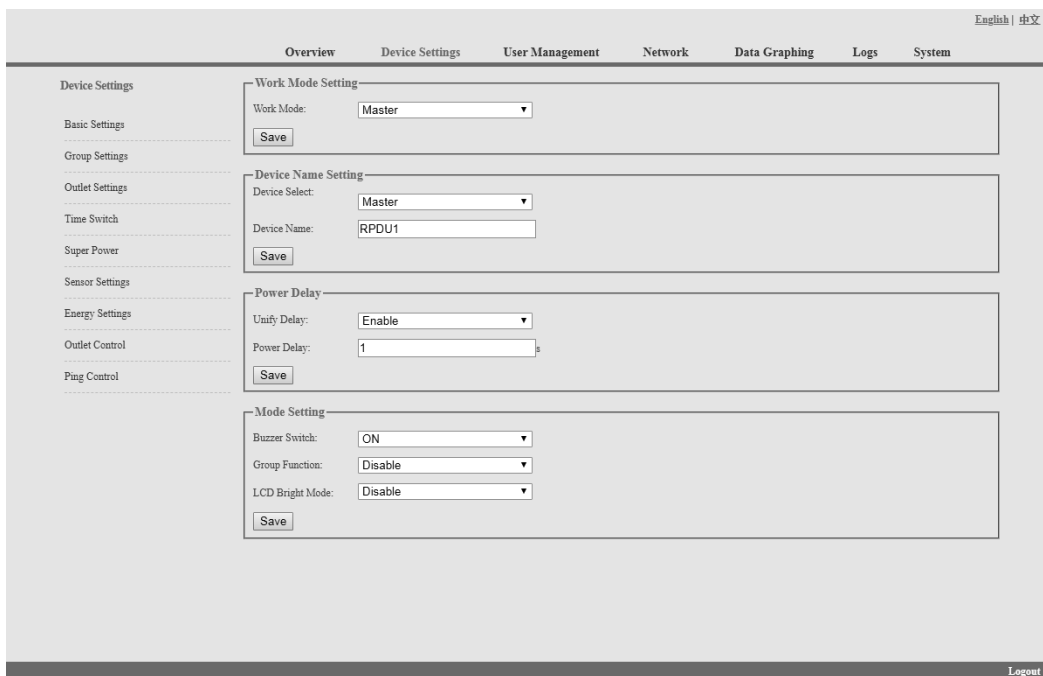

Abbildung1-3-1

C. Ausgangseinstellungen: Klicken Sie in der **Geräteverwaltung** auf **Ausgangseinstellung**, um die folgende Abbildung 1-3-2 aufzurufen

- Ausgangsname: Um jeden einzelnen Ausgang umzubenennen, und klicken Sie zum Abschluss auf "Speichern"
- Einstellung des Schwellenwerts für den einzelnen Ausgang: Geben Sie den benutzerdefinierten Schwellenwert für den Alarm ein
- Die Einstellung "near threshold of individual outlet": Konfigurieren Sie den Warnwert für die nahe Überlast für den einzelnen Ausgang
- Individuelle Einstellung der Stromverzögerung: Wenn die einheitliche Stromverzögerung deaktiviert wurde, wird der Ausgang entsprechend dem vom Benutzer eingestellten individuellen Intervall (Bereich von 0 bis 15 Sekunden) sequentiell ein- und ausgeschaltet

English | 中文

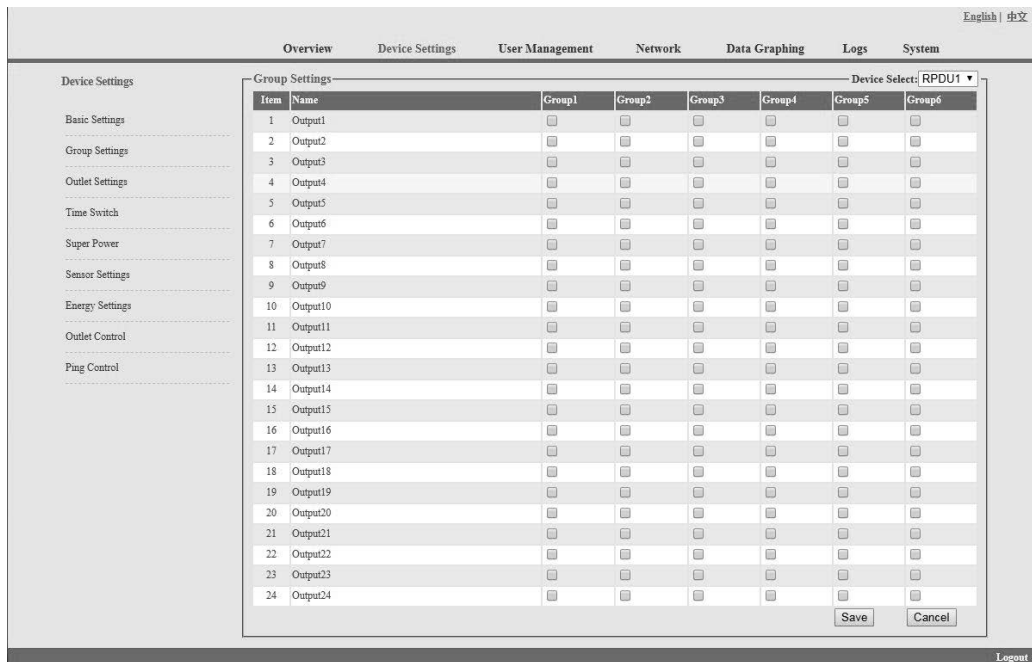
Overview    Device Settings    User Management    Network    Data Graphing    Logs    System

Device Settings

Basic Settings

Group Settings

Outlet Settings

Time Switch

Super Power

Sensor Settings

Energy Settings

Outlet Control

Ping Control

Outlet Settings Device Select: RPDU1 ▾

Item	Name	Current(A)	Min(A)	Lower(A)	upper(A)	Max(A)	Save
1	Output1	0.0	0.0	0.0	10.0	16.0	Save
2	Output2	0.1	0.0	0.0	10.0	16.0	Save
3	Output3	0.0	0.0	0.0	10.0	16.0	Save
4	Output4	0.1	0.0	0.0	10.0	16.0	Save
5	Output5	0.0	0.0	0.0	10.0	16.0	Save
6	Output6	0.0	0.0	0.0	10.0	16.0	Save
7	Output7	0.0	0.0	0.0	10.0	16.0	Save
8	Output8	0.0	0.0	0.0	10.0	16.0	Save
9	Output9	0.0	0.0	0.0	10.0	16.0	Save
10	Output10	0.0	0.0	0.0	10.0	16.0	Save
11	Output11	0.0	0.0	0.0	10.0	16.0	Save
12	Output12	0.0	0.0	0.0	10.0	16.0	Save
13	Output13	0.0	0.0	0.0	10.0	16.0	Save
14	Output14	0.0	0.0	0.0	10.0	16.0	Save
15	Output15	0.0	0.0	0.0	10.0	16.0	Save
16	Output16	0.0	0.0	0.0	10.0	16.0	Save
17	Output17	0.0	0.0	0.0	10.0	16.0	Save
18	Output18	0.0	0.0	0.0	10.0	16.0	Save
19	Output19	0.0	0.0	0.0	10.0	16.0	Save
20	Output20	0.0	0.0	0.0	10.0	16.0	Save
21	Output21	0.0	0.0	0.0	10.0	16.0	Save
22	Output22	0.0	0.0	0.0	10.0	16.0	Save
23	Output23	0.0	0.0	0.0	10.0	16.0	Save
24	Output24	0.0	0.0	0.0	10.0	16.0	Save

Logout

Abbildung 1-3-2

D. Aktion der Steckdose planen: Sie können eine bestimmte Zeit festlegen, zu der jede einzelne Steckdose automatisch ein- und ausgeschaltet wird. Das Zeitformat ist Jahr-Monat-Tag-Stunde: Minuten, z. B.: 2015-05-27 13:52, kreuzen Sie das Feld dahinter an, dann wird die Steckdose entsprechend der eingestellten Zeit ein- und ausgeschaltet;

**Hinweis: Bitte kalibrieren Sie die Gerätezeit, bevor Sie die Ausgangsaktion planen**

English | 中文

Overview    Device Settings    User Management    Network    Data Graphing    Logs    System

Device Settings

Basic Settings

Group Settings

Outlet Settings

Time Switch

Super Power

Sensor Settings

Energy Settings

Outlet Control

Ping Control

Time Switch Device Select: RPDU1 ▾

Item	Name	Power on time	Power off time	Cycle	Select
1	Output1	1970-01-01 00:00	1970-01-01 00:00	<input type="checkbox"/>	<input type="checkbox"/>
2	Output2	1970-01-01 00:00	1970-01-01 00:00	<input type="checkbox"/>	<input type="checkbox"/>
3	Output3	1970-01-01 00:00	1970-01-01 00:00	<input type="checkbox"/>	<input type="checkbox"/>
4	Output4	1970-01-01 00:00	1970-01-01 00:00	<input type="checkbox"/>	<input type="checkbox"/>
5	Output5	1970-01-01 00:00	1970-01-01 00:00	<input type="checkbox"/>	<input type="checkbox"/>
6	Output6	1970-01-01 00:00	1970-01-01 00:00	<input type="checkbox"/>	<input type="checkbox"/>
7	Output7	1970-01-01 00:00	1970-01-01 00:00	<input type="checkbox"/>	<input type="checkbox"/>
8	Output8	1970-01-01 00:00	1970-01-01 00:00	<input type="checkbox"/>	<input type="checkbox"/>
9	Output9	1970-01-01 00:00	1970-01-01 00:00	<input type="checkbox"/>	<input type="checkbox"/>
10	Output10	1970-01-01 00:00	1970-01-01 00:00	<input type="checkbox"/>	<input type="checkbox"/>
11	Output11	1970-01-01 00:00	1970-01-01 00:00	<input type="checkbox"/>	<input type="checkbox"/>
12	Output12	1970-01-01 00:00	1970-01-01 00:00	<input type="checkbox"/>	<input type="checkbox"/>
13	Output13	1970-01-01 00:00	1970-01-01 00:00	<input type="checkbox"/>	<input type="checkbox"/>
14	Output14	1970-01-01 00:00	1970-01-01 00:00	<input type="checkbox"/>	<input type="checkbox"/>
15	Output15	1970-01-01 00:00	1970-01-01 00:00	<input type="checkbox"/>	<input type="checkbox"/>
16	Output16	1970-01-01 00:00	1970-01-01 00:00	<input type="checkbox"/>	<input type="checkbox"/>
17	Output17	1970-01-01 00:00	1970-01-01 00:00	<input type="checkbox"/>	<input type="checkbox"/>
18	Output18	1970-01-01 00:00	1970-01-01 00:00	<input type="checkbox"/>	<input type="checkbox"/>
19	Output19	1970-01-01 00:00	1970-01-01 00:00	<input type="checkbox"/>	<input type="checkbox"/>
20	Output20	1970-01-01 00:00	1970-01-01 00:00	<input type="checkbox"/>	<input type="checkbox"/>
21	Output21	1970-01-01 00:00	1970-01-01 00:00	<input type="checkbox"/>	<input type="checkbox"/>
22	Output22	1970-01-01 00:00	1970-01-01 00:00	<input type="checkbox"/>	<input type="checkbox"/>
23	Output23	1970-01-01 00:00	1970-01-01 00:00	<input type="checkbox"/>	<input type="checkbox"/>
24	Output24	1970-01-01 00:00	1970-01-01 00:00	<input type="checkbox"/>	<input type="checkbox"/>

Logout

Abbildung 1-3-3

### E. Leistungsabschaltung bei Überlast

Der Benutzer kann die Stromabschaltfunktion entsprechend aktivieren. Die PDU schaltet den Überlastausgang automatisch ab, wenn diese Funktion aktiviert wurde, siehe Abbildung 1-3-4

English | 中文

Overview    Device Settings    User Management    Network    Data Graphing    Logs    System

Device Settings

Basic Settings

Group Settings

Outlet Settings

Time Switch

Super Power

Sensor Settings

Energy Settings

Outlet Control

Ping Control

Super Power Device Select: RPDU1 ▾

Item	Name	Current(A)	Min(A)	Max(A)	select
1	Output1	0.0	0.0	16.0	<input type="checkbox"/>
2	Output2	0.1	0.0	16.0	<input type="checkbox"/>
3	Output3	0.0	0.0	16.0	<input type="checkbox"/>
4	Output4	0.1	0.0	16.0	<input type="checkbox"/>
5	Output5	0.0	0.0	16.0	<input type="checkbox"/>
6	Output6	0.0	0.0	16.0	<input type="checkbox"/>
7	Output7	0.0	0.0	16.0	<input type="checkbox"/>
8	Output8	0.0	0.0	16.0	<input type="checkbox"/>
9	Output9	0.0	0.0	16.0	<input type="checkbox"/>
10	Output10	0.0	0.0	16.0	<input type="checkbox"/>
11	Output11	0.0	0.0	16.0	<input type="checkbox"/>
12	Output12	0.0	0.0	16.0	<input type="checkbox"/>
13	Output13	0.0	0.0	16.0	<input type="checkbox"/>
14	Output14	0.0	0.0	16.0	<input type="checkbox"/>
15	Output15	0.0	0.0	16.0	<input type="checkbox"/>
16	Output16	0.0	0.0	16.0	<input type="checkbox"/>
17	Output17	0.0	0.0	16.0	<input type="checkbox"/>
18	Output18	0.0	0.0	16.0	<input type="checkbox"/>
19	Output19	0.0	0.0	16.0	<input type="checkbox"/>
20	Output20	0.0	0.0	16.0	<input type="checkbox"/>
21	Output21	0.0	0.0	16.0	<input type="checkbox"/>
22	Output22	0.0	0.0	16.0	<input type="checkbox"/>
23	Output23	0.0	0.0	16.0	<input type="checkbox"/>
24	Output24	0.0	0.0	16.0	<input type="checkbox"/>

Logout

Abbildung 1-3-4

F. Sensoreinstellungen: Stellen Sie die Schwellenwerte für Temperatur und Luftfeuchtigkeit wie in Abbildung 1-3-5 ein

English | 中文

Overview Device Settings User Management Network Data Graphing Logs System

Device Settings

Device Select: RPDU1

Item	Name	Current value	Min	Max	Save
1	Temperature1	25	0	40	Save
2	Temperature2	25	0	40	Save
3	Temperature3	26	0	40	Save
4	Temperature4	0	0	40	Save
5	Humidity1	65	0	99	Save
6	Humidity2	63	0	99	Save
7	Humidity3	65	0	99	Save
8	Humidity4	0	0	99	Save
9	Total Load(L1)	0.2	0.0	32.0	Save
10	Total Load(L2)	0.0	0.0	32.0	Save

Logout

Abbildung 1-3-5

G. Energie-Einstellung: Klicken Sie auf die **Energieeinstellung** im **Geräteverwaltungsmenü** (Abbildung 1-3-6).

Der Benutzer kann den Stromverbrauch jedes einzelnen Geräts anzeigen und auf die Schaltfläche "Reset" (Zurücksetzen) klicken, um die Kilowattstunden auf Null zurückzusetzen; der Gesamtstromverbrauch wird auch von der Steckdose abgezogen.



English | 中文

Overview    Device Settings    User Management    Network    Data Graphing    Logs    System

Device Settings Device Select: RPDU1 ▾

Item	Name	Energy(kWh)	Reset
1	Output1	0.0	Energy reset
2	Output2	0.0	Energy reset
3	Output3	0.0	Energy reset
4	Output4	0.0	Energy reset
5	Output5	0.0	Energy reset
6	Output6	0.0	Energy reset
7	Output7	0.0	Energy reset
8	Output8	0.0	Energy reset
9	Output9	0.0	Energy reset
10	Output10	0.0	Energy reset
11	Output11	0.0	Energy reset
12	Output12	0.0	Energy reset
13	Output13	0.0	Energy reset
14	Output14	0.0	Energy reset
15	Output15	0.0	Energy reset
16	Output16	0.0	Energy reset
17	Output17	0.0	Energy reset
18	Output18	0.0	Energy reset
19	Output19	0.0	Energy reset
20	Output20	0.0	Energy reset
21	Output21	0.0	Energy reset
22	Output22	0.0	Energy reset
23	Output23	0.0	Energy reset
24	Output24	0.0	Energy reset
All Energy			Energy reset

Logout

Abbildung 1-3-6

H. Ausgangskontrolle: Klicken Sie auf die **Ausgangssteuerung** im Menü **Geräteverwaltung**, siehe Abbildung 1-3-6

- a. Der Benutzer kann jeden einzelnen Ausgang ein-/ausschalten/neustarten, indem er auf die entsprechenden;
- b. Außerdem kann der Benutzer alle Steckdosen auf einmal ein- oder ausschalten, indem er auf die Schaltfläche ALL on/off klickt

Overview    Device Settings    User Management    Network    Data Graphing    Logs    System

Device Settings

Basic Settings

Group Settings

Outlet Settings

Time Switch

Super Power

Sensor Settings

Energy Settings

Outlet Control

Ping Control

Outlet Control ————— Device Select: RPDU1 ▾

Item	Name	Status	On	Off	Cycle
1	Output1	ON	On	Off	Cycle
2	Output2	ON	On	Off	Cycle
3	Output3	ON	On	Off	Cycle
4	Output4	ON	On	Off	Cycle
5	Output5	ON	On	Off	Cycle
6	Output6	ON	On	Off	Cycle
7	Output7	ON	On	Off	Cycle
8	Output8	ON	On	Off	Cycle
9	Output9	ON	On	Off	Cycle
10	Output10	ON	On	Off	Cycle
11	Output11	ON	On	Off	Cycle
12	Output12	ON	On	Off	Cycle
13	Output13	ON	On	Off	Cycle
14	Output14	ON	On	Off	Cycle
15	Output15	ON	On	Off	Cycle
16	Output16	ON	On	Off	Cycle
17	Output17	ON	On	Off	Cycle
18	Output18	ON	On	Off	Cycle
19	Output19	ON	On	Off	Cycle
20	Output20	ON	On	Off	Cycle
21	Output21	ON	On	Off	Cycle
22	Output22	ON	On	Off	Cycle
23	Output23	ON	On	Off	Cycle
24	Output24	ON	On	Off	Cycle
	ALL		On	Off	

Logout

Abbildung 1-3-7

## I. Ping-Steuerung

Verwenden Sie den PING-Befehl, um die IP-Adresse des entsprechenden Netzwerkgeräts von der ersten bis zur achten Steckdose anzupingen. Wenn auf Ping keine Antwort erfolgt, wird die Stromversorgung der Steckdosen ein- und ausgeschaltet, um die Stromversorgung der Netzwerkgeräte zu gewährleisten.

- Geben Sie die entsprechende Eingangs-IP-Adresse in das IP-Eingabefeld ein, die vom Netzwerkgerät gesteuert wird.
- Wählen Sie die Dropdown-Box-Optionen von ACTION, der Standard-Systembefehl ist NONE, PING-keine Antwort, das System führt keine Operation der entsprechenden Ausgänge durch; Wenn Sie die Optionen ON / OFF / Once wählen, Ping- keine Antwort, führt das System die entsprechenden Ausgänge ein/aus oder startet eine Operation neu; Wenn Sie die Option Cycle wählen, Ping- keine Antwort, wiederholen die entsprechenden Ausgänge die Neustart-Operation in Zeitabständen.
- Die Intervallzeit des Neustartbefehls für die Ausgänge beträgt 3s (Systemvorgabe), der Bereich sollte nicht kleiner als 3s sein. Klicken Sie auf die Schaltfläche "Übernehmen", um die Ping-Funktion zu aktivieren. Wenn die Ping-Funktion aktiviert ist, werden die Protokolle des Betriebs der Ping-Funktion erstellt.

**Hinweis: Wenn Ping normal läuft, führen die Ausgänge keine Betriebsbefehle aus. Die anderen Ausgänge, die die Netzwerkgeräte-IP verbinden, können diese Funktion nicht nutzen.**



Abbildung 1-3-8

**3.2.1.3. Benutzerverwaltung: Klicken Sie auf die Benutzerverwaltung in der Navigationsleiste (Abbildung 1-4), um Benutzer, Benutzergruppen und Zugriffsrechte zu verwalten**

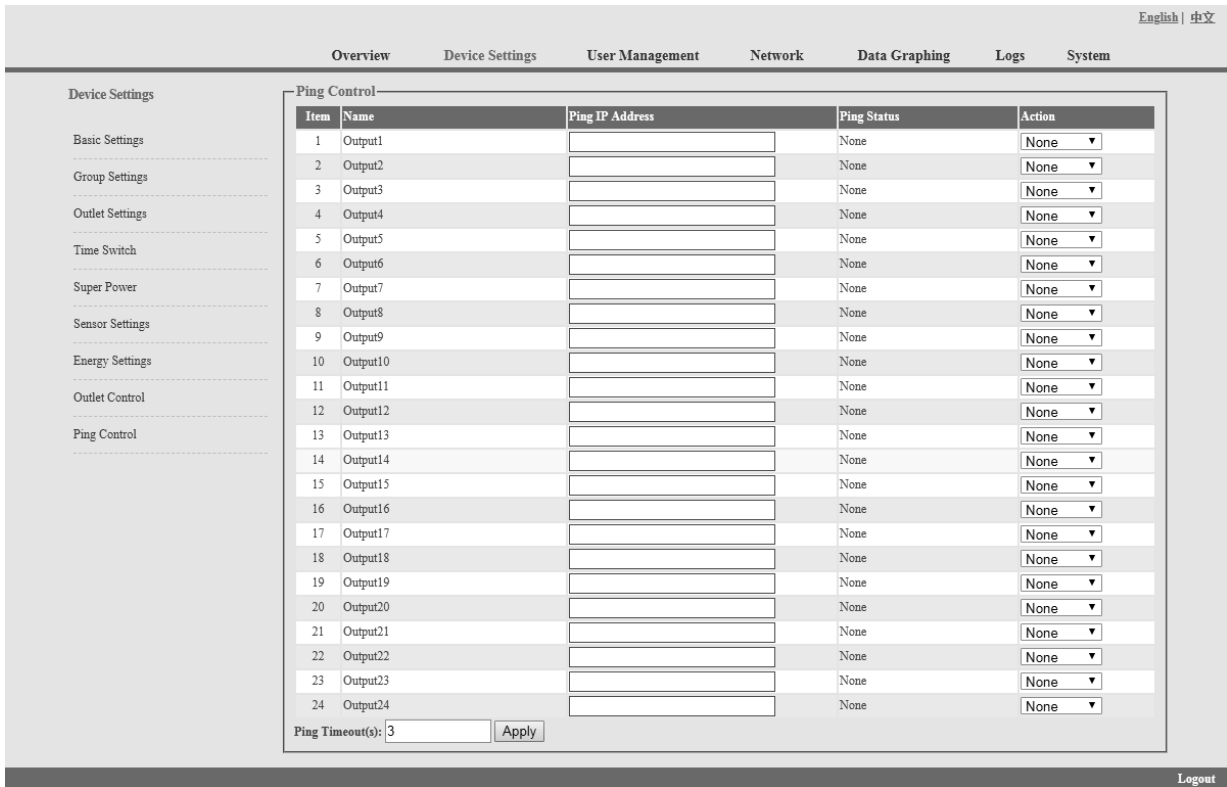

Abbildung 1-4

A. Benutzereinstellungen: Klicken Sie auf die Benutzereinstellungen im Menü Benutzerverwaltung wie in Abbildung 1-4 dargestellt

1. Neues Konto erstellen: Klicken Sie auf Benutzereinstellungen und geben Sie den neuen Benutzernamen und das Passwort ein, Klicken Sie zum Abschluss auf Hinzufügen
2. Konto bearbeiten: Klicken Sie auf Benutzereinstellungen, geben Sie den geänderten Benutzernamen und das Passwort auf der rechten Seite ein und klicken Sie auf Ändern, um die Bearbeitung abzuschließen.
3. Konto löschen: Klicken Sie auf Benutzereinstellungen und wählen Sie das Konto aus der Dropdown-Liste aus, dann klicken Sie auf **Löschen**, um zu beenden
4. Neue Benutzergruppe erstellen: Klicken Sie auf "User Group Settings" (Benutzergruppeneinstellungen), geben Sie den Namen der neuen Benutzergruppe ein und konfigurieren Sie die entsprechenden Rechte, und klicken Sie dann auf "Save" (Speichern)

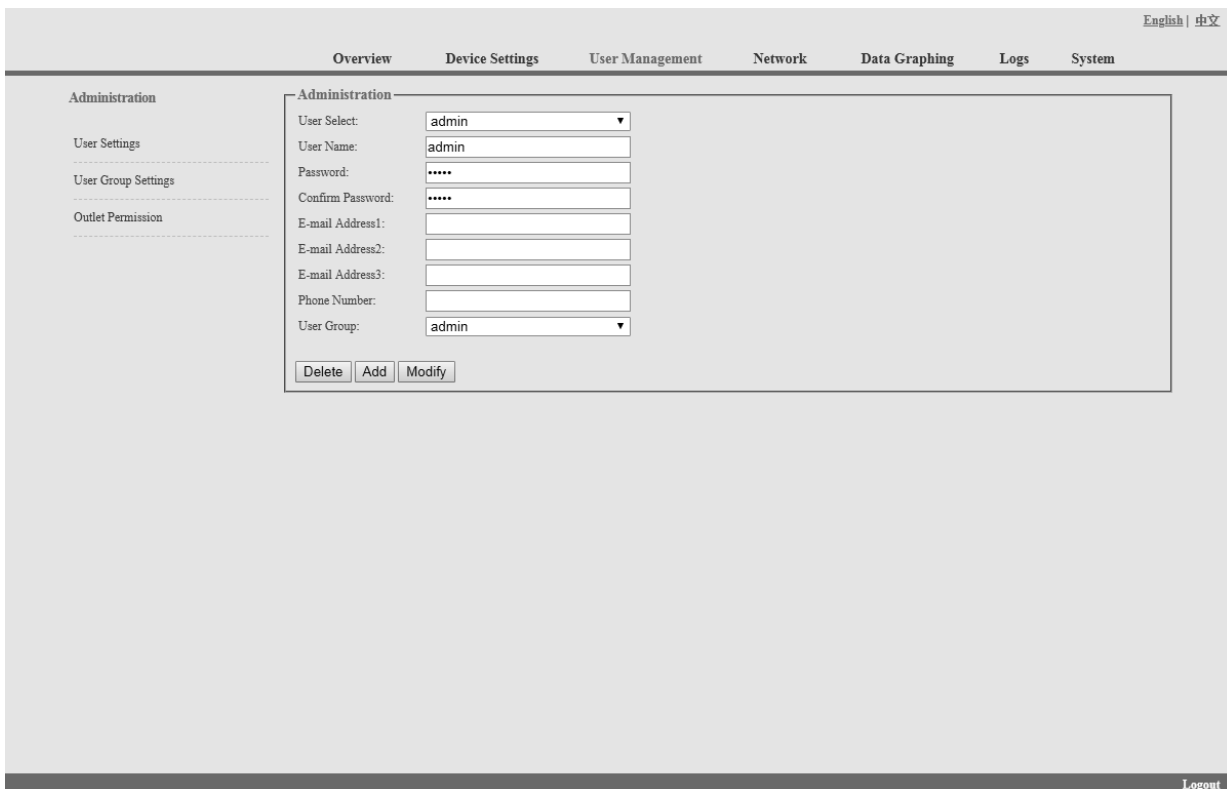

Abbildung 1-4-1

5. Bearbeiten Sie die Benutzergruppe: Klicken Sie auf die Einstellungen der Benutzergruppe, geben Sie dann den geänderten Benutzergruppennamen ein und klicken Sie zum Abschluss auf Speichern
6. Benutzergruppe löschen: Klicken Sie auf die Einstellungen der Benutzergruppe, wählen Sie die Benutzergruppe aus der Dropdown-Liste und klicken Sie zum Abschluss auf die Schaltfläche Löschen
7. Bearbeiten Sie die Rechte der Benutzergruppe: Wählen Sie die Benutzergruppe aus der Dropdown-Liste und haken Sie die Rechte entsprechend ab, klicken Sie zum Abschluss auf Speichern

Der Benutzer kann verschiedenen Benutzergruppen unterschiedliche Zugriffsrechte für den Ausgang zuweisen, klicken Sie zum Abschluss auf Speichern oder Löschen. Siehe Abbildung 1-4-2

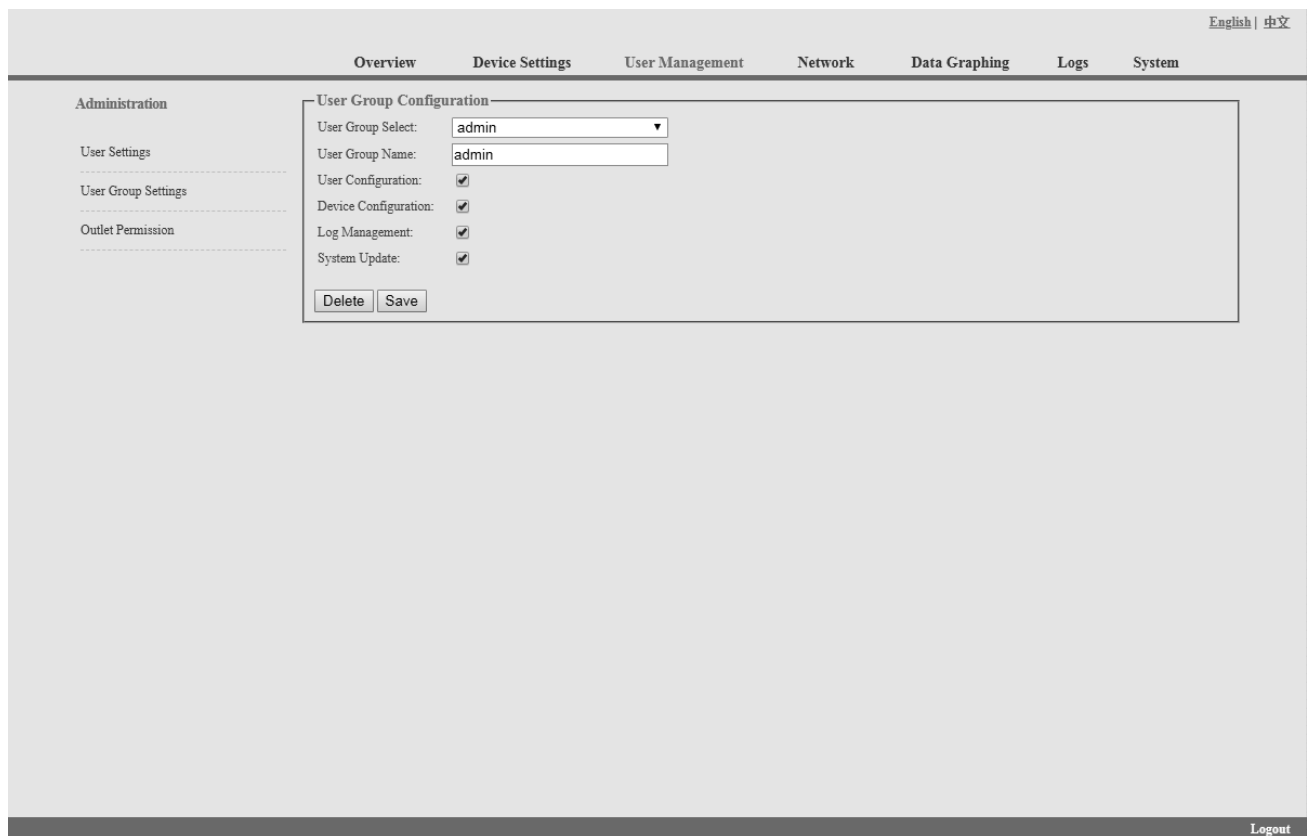

Abbildung 1-4-2

**3.2.1.4 Netzwerkeinstellungen: Klicken Sie in der Navigationsleiste auf die Netzwerkeinstellungen, siehe Abbildung 1-5**

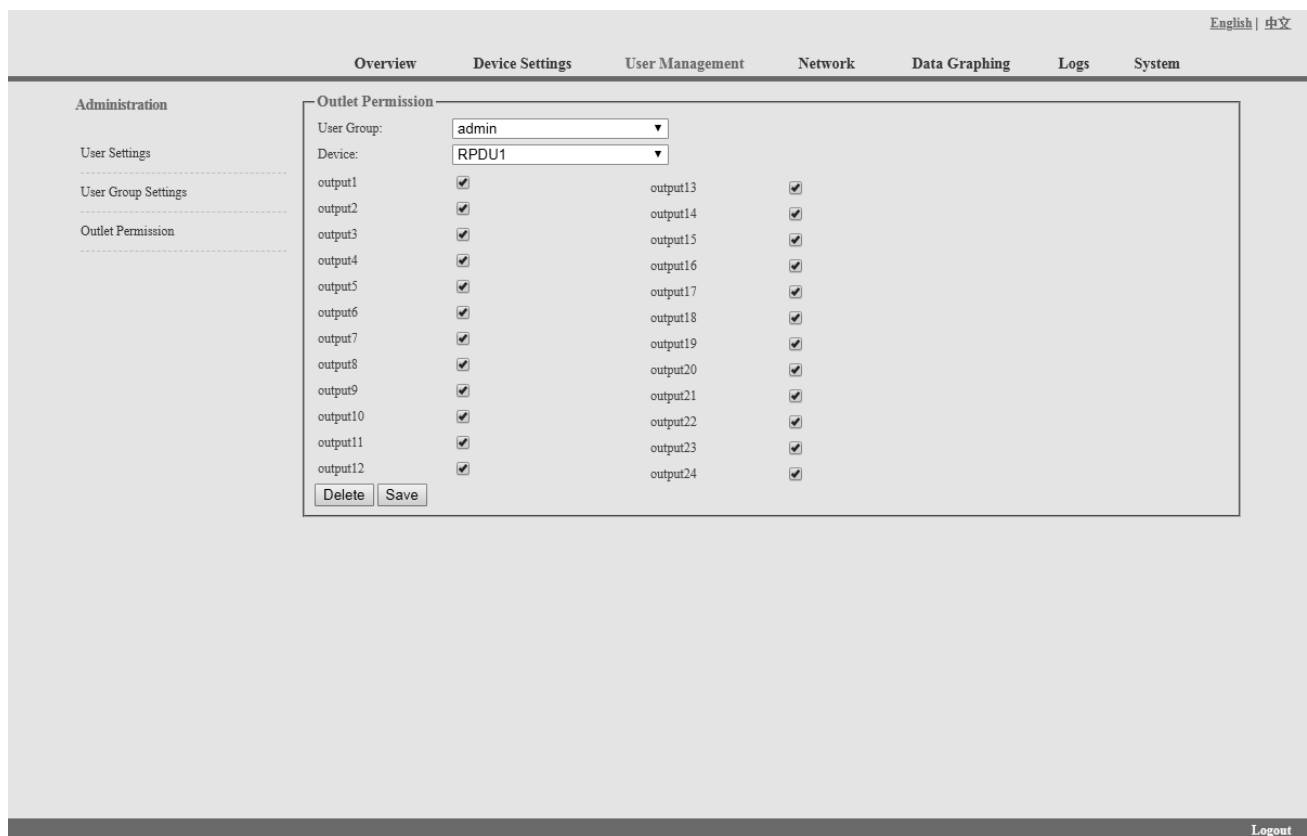

Abbildung 1-5

**Hinweis: Die Netzwerkeinstellungen umfassen die Bereiche Netzwerk, WIFI, HTTP, SSH, FTP, Modbus, SNMP, Telnet, SMTP, NTP, Radius und SYSOLOG**

- A. Netzwerk: Der Benutzer kann das Netzwerk durch manuelle oder automatische Erfassung konfigurieren.
- a. Manuelle Einstellung:
    - IP: 192.168.1.163 (Werkseitige Standard-IP);
    - Subnetzmaske: 255.255.255.0
    - Gateway: 192.168.1.1
    - DNS: Standardmäßig 0.0.0.0;
 Sie sollten den richtigen DNS eingeben, um den E-Mail-Versand zu gewährleisten.

**Hinweis: Bitte starten Sie die Software neu, nachdem Sie die Netzwerkeinstellungen geändert haben.**

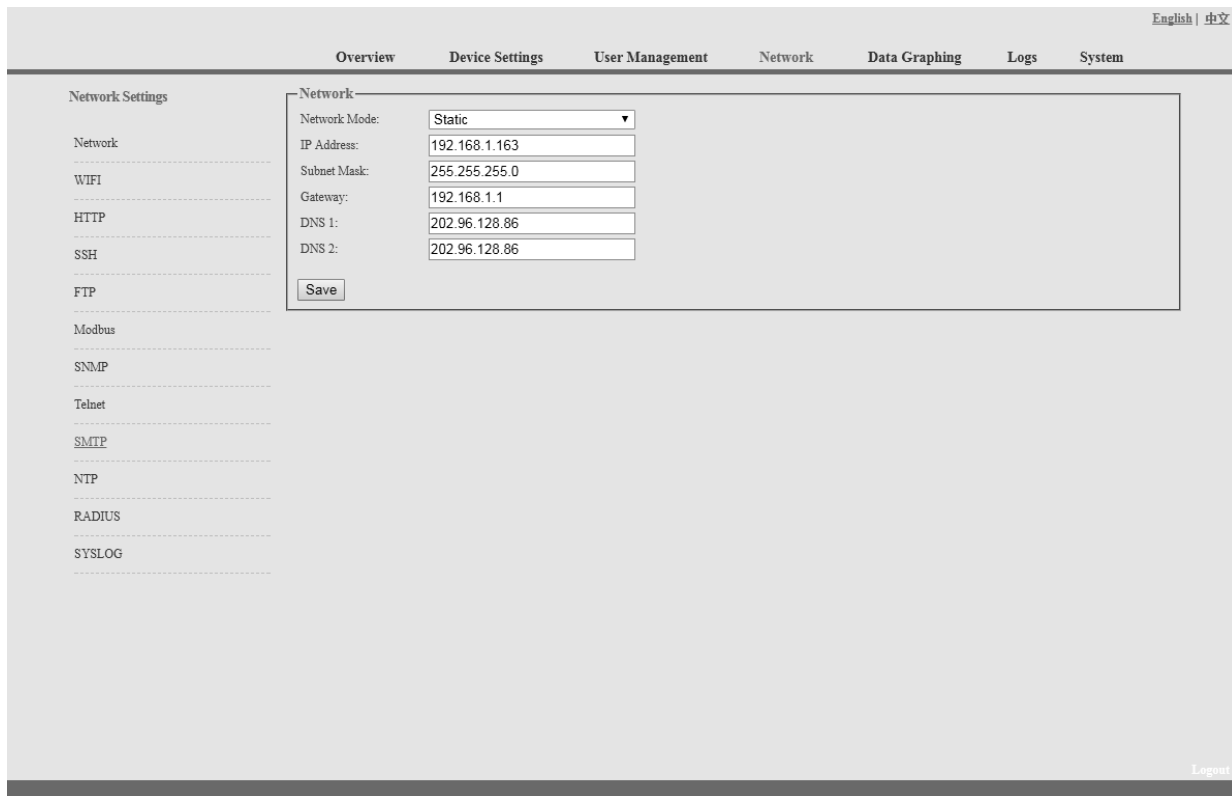
- b. Automatische Erfassung:
  - Wählen Sie "Automatische Erfassung" und klicken Sie auf "Speichern", dann starten Sie die Software neu, das Gerät erhält die IP automatisch. Die IP kann auf dem LCD angezeigt werden.

## B. WIFI-Einstellungen:

Stecken Sie die drahtlose Netzwerkkarte in den USB-Anschluss

### 1. WIFI-Signal-Suche:

Klicken Sie auf "Netzwerk suchen", um alle drahtlosen Netzwerke in der Nähe zu finden.

### 2. Enable WIFI: Wählen Sie "Enable", geben Sie SSID und Passwort ein und speichern Sie.

### 3. WIFI-Netzwerkeinstellungen

Netzwerkmodus kann manuelle oder automatische Erfassung sein

Manuelle Einstellungen wie unten:

IP-Adresse: Stellen Sie die WIFI-IP im LAN ein wie 192.168.1.191

Subnetzmaske: entspricht der IP-Adresse, z. B. 255.255.255.0

Gateway: entspricht der IP-Adresse, z. B. 192.168.1.1

DNS: Standardmäßig ist DNS 0.0.0.0

Automatische Erfassung

Füllen Sie die WIFI-Verbindungseinstellungen aus und speichern Sie, wählen Sie die automatische Erfassung aus der Dropdown-Liste der WIFI-Netzwerkeinstellungen und speichern Sie. Dann starten Sie das Gerät neu und das System wird die IP-Adresse innerhalb des LANs erfassen und die Adresse kann auf dem LCD-Bildschirm angezeigt werden.

The screenshot displays the 'Network Settings' page of a device's web management interface. The page has a top navigation bar with tabs for 'Overview', 'Device Settings', 'User Management', 'Network', 'Data Graphing', 'Logs', and 'System'. The 'Network' tab is selected. On the left side, there is a vertical menu with options: Network Settings, Network, WIFI, HTTP, SSH, FTP, Modbus, SNMP, Telnet, SMTP, NTP, RADIUS, and SYSLOG. The main content area is divided into three sections:

- WIFI Connection Setting:** Contains a 'Network Mode' dropdown menu set to 'Disable', an 'SSID' text input field with 'link' entered, and a 'Password' text input field with masked characters. A 'Save' button is located below these fields.
- WIFI Network Setting:** Contains a 'Network Mode' dropdown menu set to 'Manual', an 'IP address' text input field with '192.168.1.191' entered, a 'Subnet Mask' text input field with '255.255.255.0' entered, a 'Gateway' text input field with '192.168.1.1' entered, a 'DNS 1' text input field with '202.96.128.86' entered, and a 'DNS 2' text input field with '202.96.128.86' entered. A 'Save' button is located below these fields.
- WIFI Signal Searching:** Contains a single 'Search Network' button.

The interface also includes a language selector 'English | 中文' in the top right corner and a 'Logout' link in the bottom right corner.

Abbildung 1-6

C. HTTP: Geben Sie den richtigen HTTP-Port ein und speichern Sie; im normalen Arbeitsmodus ist der Standardport 80. HTTPS (SSL)-Modus-Port: standardmäßig als 443.

**Hinweis: Bitte starten Sie die Software neu, nachdem Sie die HTTP-Einstellungen geändert haben. Siehe Abbildung 1-7**



Abbildung 1-7



#### D. SSH-Einstellung:

Der Benutzer kann SSH aktivieren oder deaktivieren. Nach dem Speichern der Konfiguration muss das Gerät neu gestartet werden. Das SSH-Konto und -Passwort ist das Konto und das Passwort für die Anmeldung am SSH, der SSH-Port ist 22, siehe Abbildung 1-8:

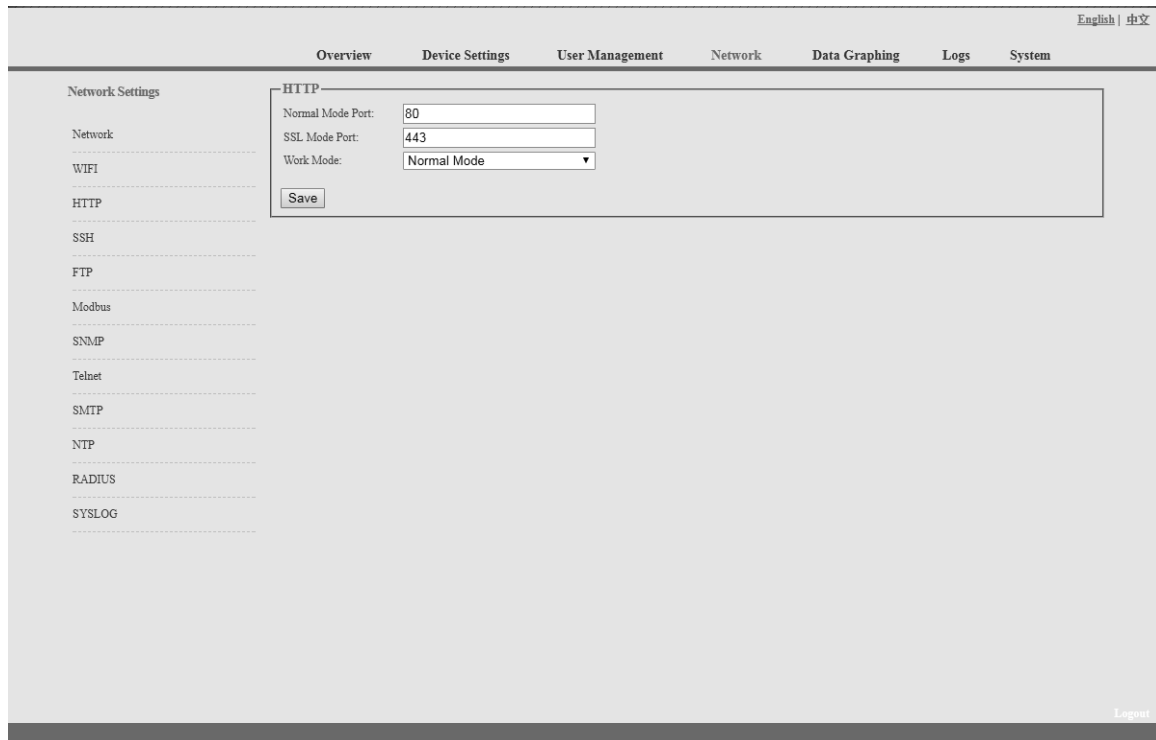
**Hinweis: Für den SSH-Befehlszeilenzugang lesen Sie bitte die Anleitung für den Telnet-Zugang.**



Abbildung 1-8

#### E. FTP

Der Benutzer kann FTP aktivieren oder deaktivieren, dazu muss das Gerät nach dem Speichern der Konfiguration neu gestartet werden. Das Konto und Passwort für FTP ist das Konto und Passwort für die Anmeldung bei SSH, der FTP-Port ist 21, siehe Abbildung 1-9:

**Hinweis: Der Benutzer kann ein Remote-Upgrade durchführen, indem er den FTP-Dienst aktiviert**

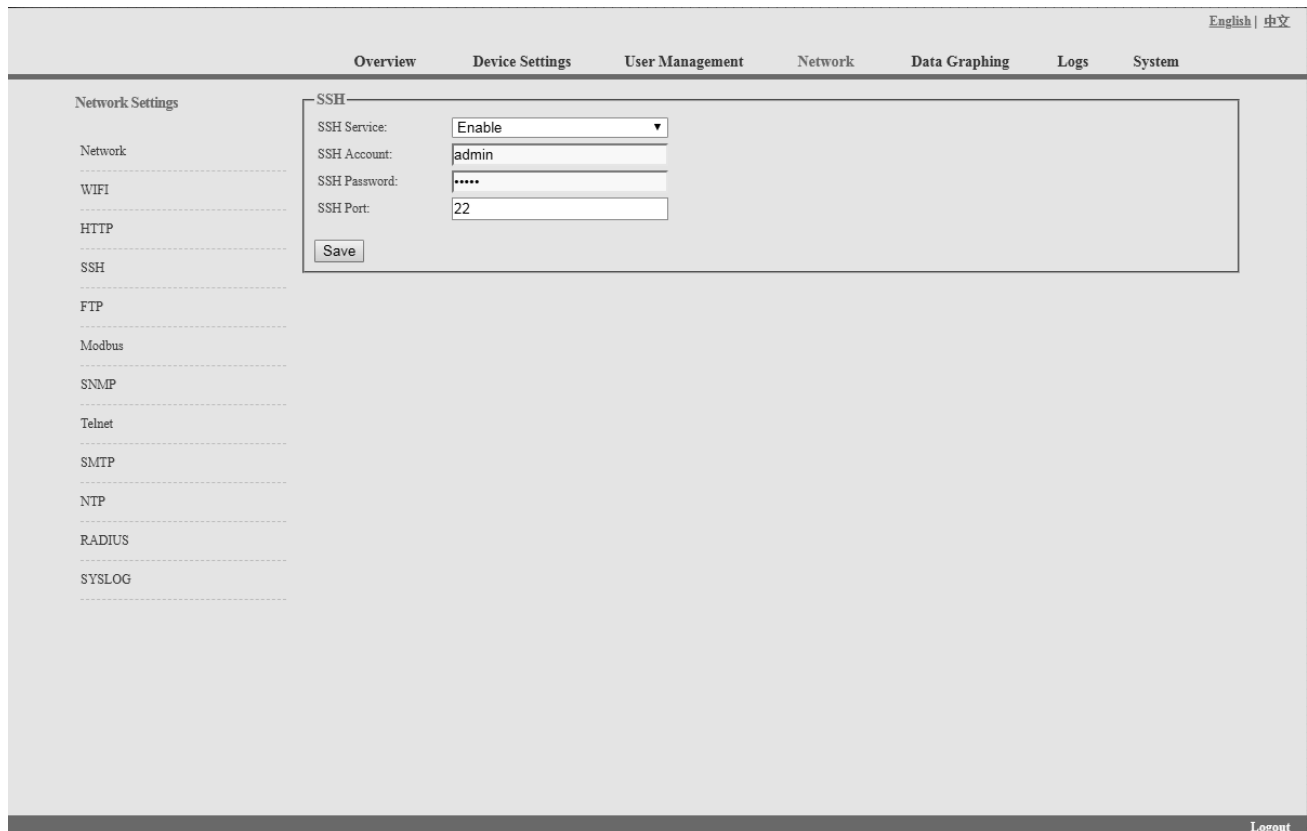

Abbildung 1-9

## F. MODBUS

Die Konfiguration des MODBUS-Protokolls umfasst MODBUS-Kommunikationsadresse (1-255), Baudrate (9600, 19200, 38400, 57600, 115200), Datenbit (6, 7, 8), Parität (N/A, gerade Zahl, ungerade Zahl), Stoppbit (1, 2)

**Hinweis: Das Master-Gerät sammelt die Daten von der SER-Schnittstelle; bitte beachten Sie die Details des MODBUS-Protokolls als Referenz.**

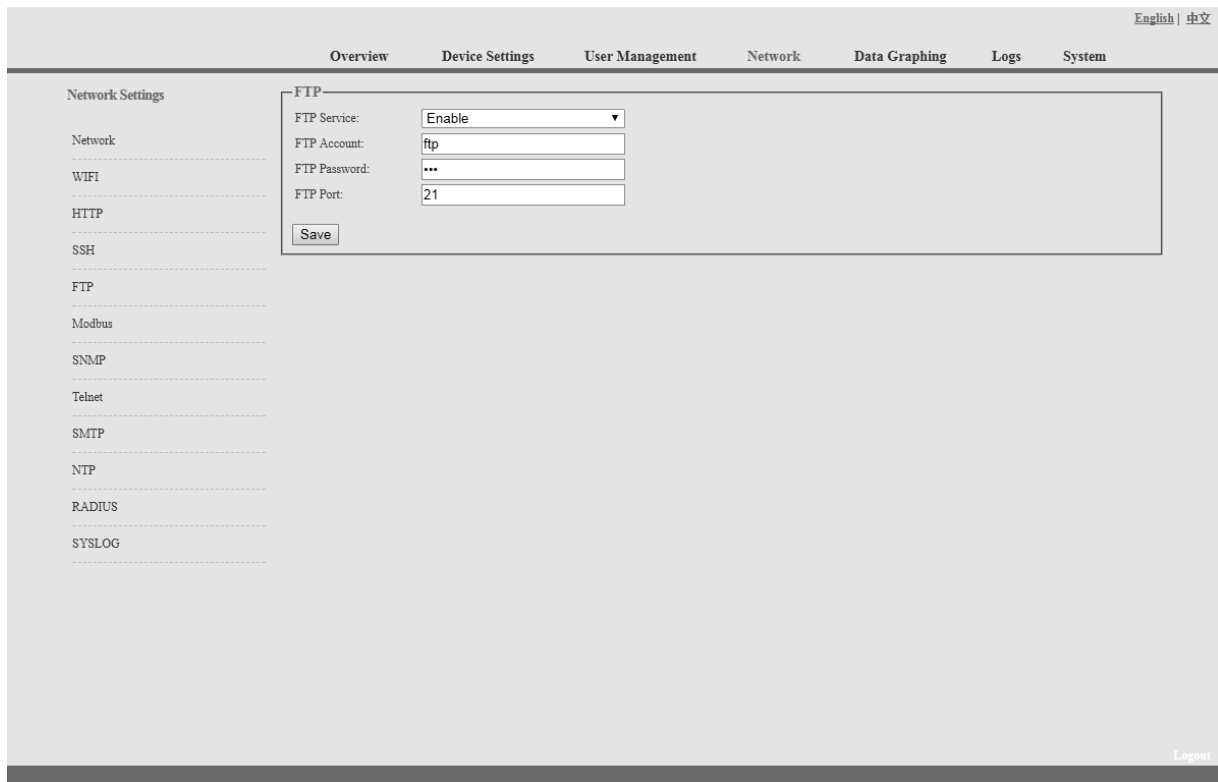
**Die SER-Schnittstelle der horizontalen SMART-PDU unterstützt entweder die Funktion des seriellen Modbus-Anschlusses oder die Funktion der externen erweiterten Sensorbox.**



Abbildung 1-10

## G. SNMP:

### NMP V1/V2c:

Der Benutzer kann entscheiden, ob er den SNMP-Zugriff über die Weboberfläche aktivieren oder deaktivieren möchte.

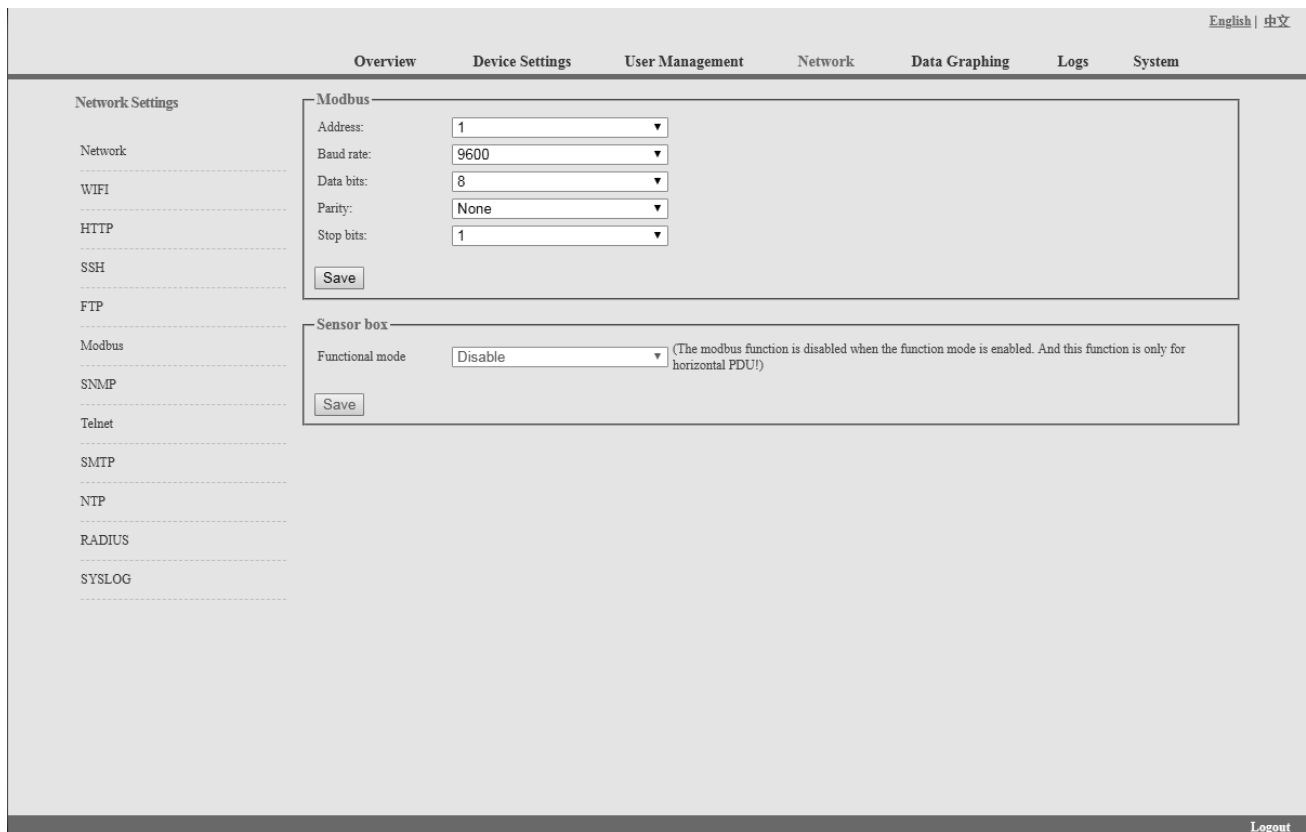
Die Aktivierung von SNMP V1 und V2C erfordert die Konfiguration von "Read Community" und "Write Community".

Die Standardeinstellungen für "Lese-Community" und "Schreib-Community" sind öffentlich und privat.

Der Benutzer kann sie entsprechend der Situation ändern.

Trap-Adresse: Es können 2 Trap-Adressen eingestellt werden. Geben Sie die Trap-Adresse der SNMP-Verwaltungsplattform ein, Trap-Informationen werden direkt an die Adressen gesendet.

SNMP-Server-Position: Aufzeichnung der Server-Positionsinformationen

SNMP v3-Einstellungen:

Wählen Sie "Aktivieren" und geben Sie Konto, Passwort und privaten Schlüssel ein.

**Hinweis: Nach dem Speichern der SNMP-Einstellungen muss die Software neu gestartet werden. Informationen zum SNMP-Zugriff finden Sie auf Seite 24.**



Abbildung 1-11

#### H. Telnet:

Telnet: Wählen Sie "Aktivieren" oder "Deaktivieren" und speichern Sie, stellen Sie sicher, dass Sie die Software nach der Änderung neu starten. Geben Sie Telnet-Konto und -Passwort wie in Abbildung 1-12 gezeigt ein, Telnet-Port ist 23.

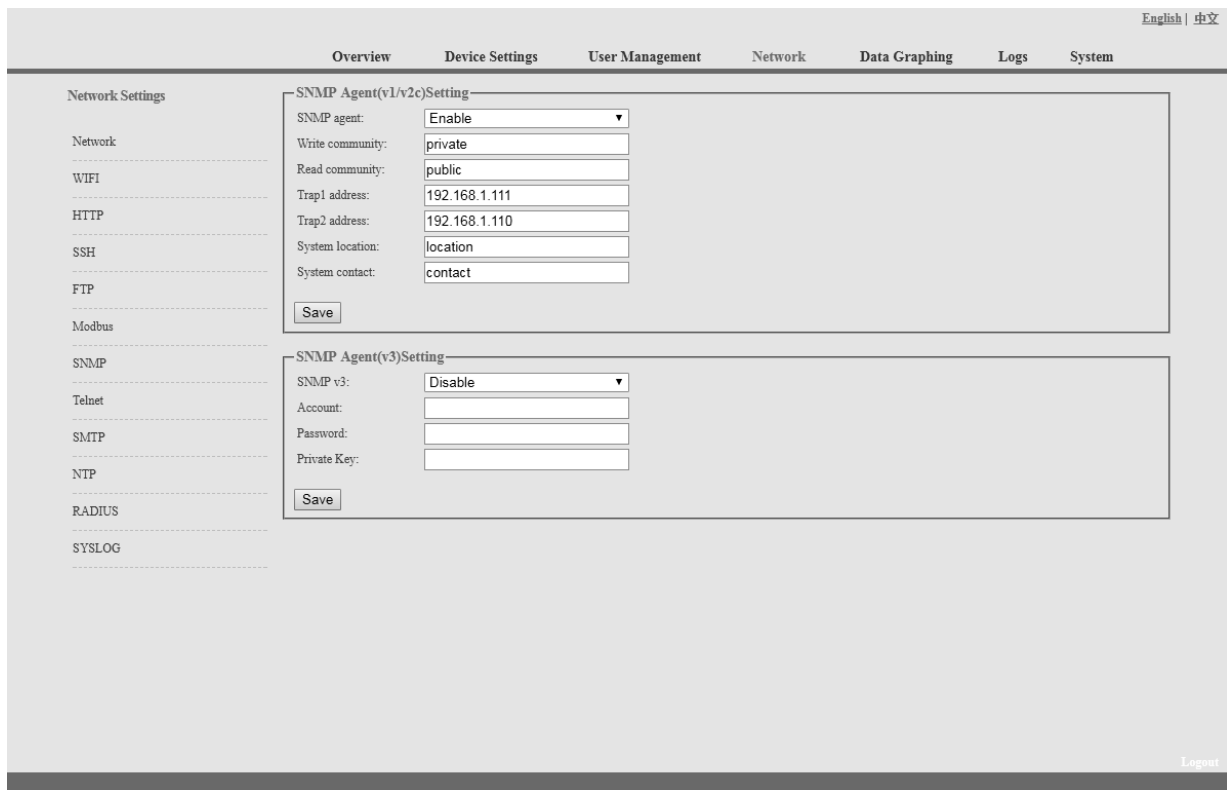

Abbildung 1-12

I. SMTP: Klicken Sie in der Netzwerkeinstellung auf SMTP, um die SMTP-Einstellung zu öffnen (siehe Abbildung 1-13).

Geben Sie die Parameter des SMTP-Dienstes ein, einschließlich SMTP-Konto, Passwort, SMTP-Server, Port und Authentifizierungsmodus. Nach dem Speichern müssen Sie die Software neu starten, damit sie wirksam wird.

SMTP-Test: Geben Sie das Empfängerkonto ein, klicken Sie auf "Test" und prüfen Sie dann das Testempfängerkonto. Wenn die Test-E-Mail empfangen wird, ist die SMTP-Einstellung erfolgreich; wenn sie nicht empfangen wird, setzen Sie bitte das SMTP zurück.

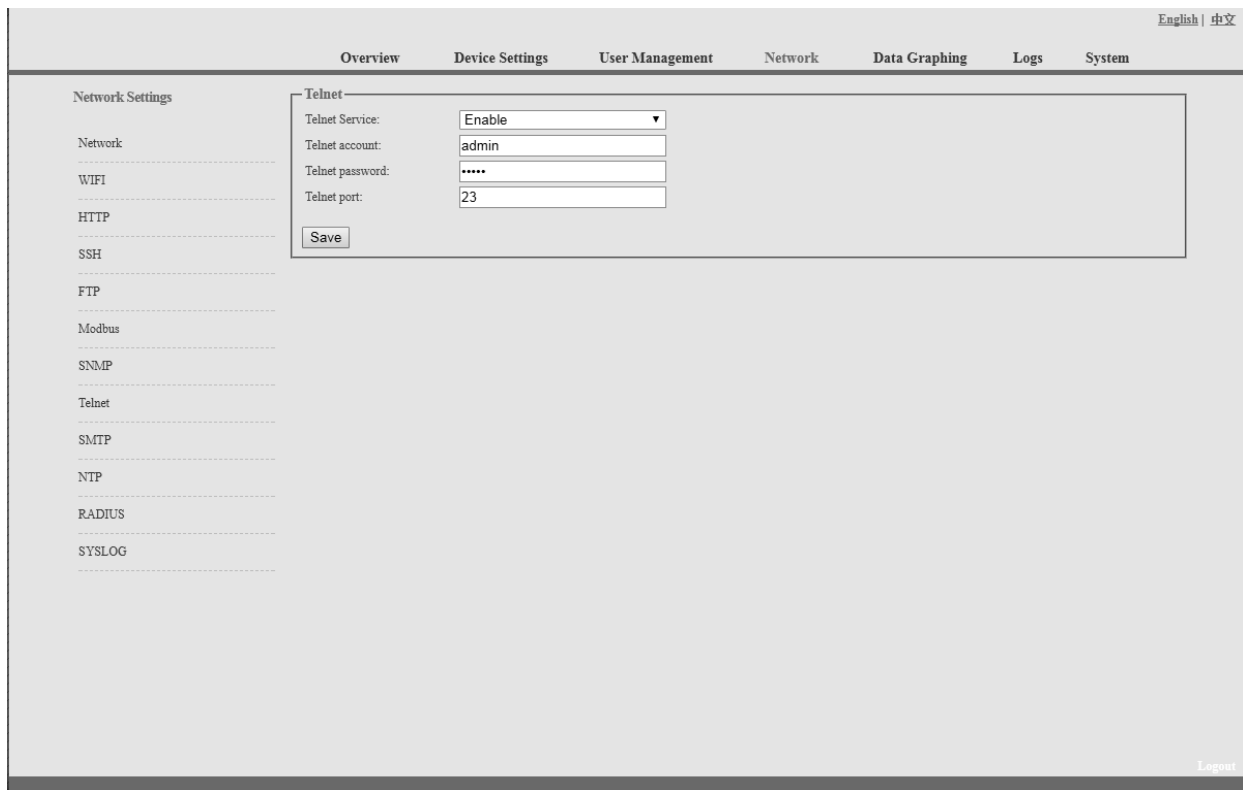

Abbildung 1-13

J. NTP-Einstellungen: Klicken Sie in den Netzwerkeinstellungen auf NTP, wie in Abbildung 1-14 dargestellt.

Die lokale Zeit ist die aktuelle Zeit des Geräteservers.

Aktivieren oder deaktivieren Sie den NTP-Dienst und klicken Sie auf Speichern. Starten Sie dann das Gerät neu.

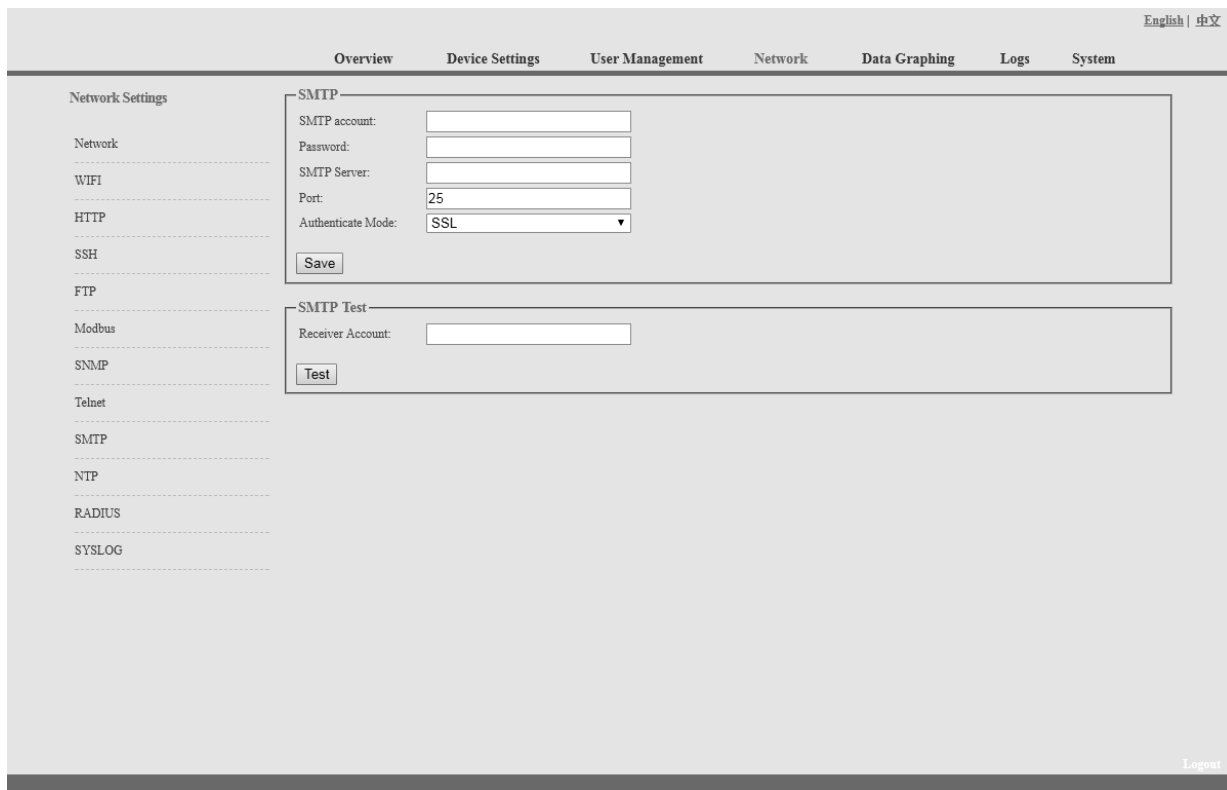
Aktivieren Sie NTP; geben Sie den NTP-Server und den Port ein und wählen Sie die Zeitzone, klicken Sie auf "Speichern".

Klicken Sie auf "Synchronisation", das Gerät wird auf die lokale Systemzeit gemäß der aktuellen Zeitzone und Datum aus dem Internet

Benutzerdefinierte Einstellung: Sie müssen zuerst das NTP deaktivieren und dann Datum und Uhrzeit eingeben.



Abbildung 1-14

## K. RADIUS

Der Benutzer kann zwischen Basisauthentifizierung und Radius-Authentifizierung wählen. Wählen Sie Radius-Authentifizierung, wird das Gerät das Benutzerkonto vom Radius-Server authentifizieren.

Server-Adresse: Geben Sie die Adresse des Radius-Servers ein.

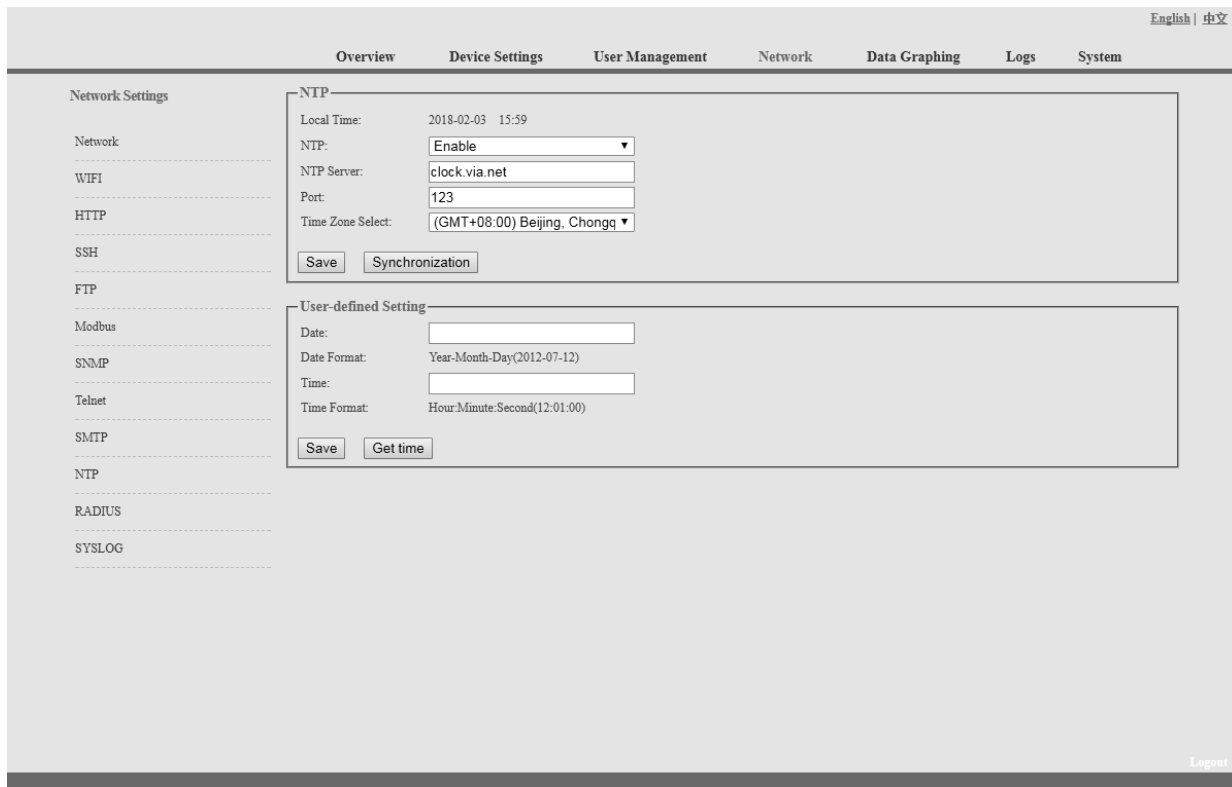
Gemeinsames Geheimnis: Geben Sie den erforderlichen öffentlichen Schlüssel des Radius-Servers ein.

**Hinweis: Bitte starten Sie die Software nach der Konfiguration neu. Geben Sie dann das angeforderte Konto und Kennwort des Radius-Servers ein; nach der Authentifizierung kann der Benutzer auf das Gerät zugreifen.**



Abbildung 1-15

L. SYSLOG: Geben Sie die IP-Adresse des SYSLOG-Servers ein, wie in Abbildung 1-16 gezeigt

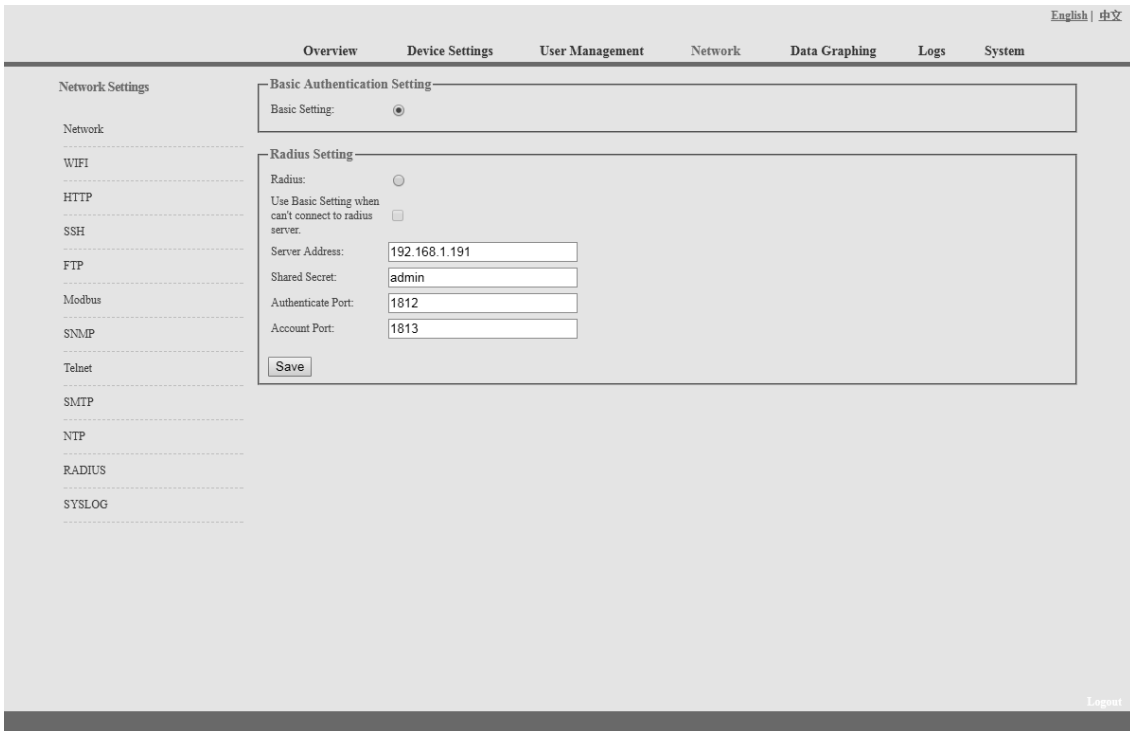

Abbildung 1-16

**Hinweis: SYSLOG enthält Informationen über den Systemstart, Servicefehler während des Betriebs und Befehlsfehler. Starten Sie die Software nach dem Speichern der SYSLOG-Serveradresse neu, damit sie wirksam wird.**



### 2.1.5. Datengrafik

Wählen Sie das Gerät aus und prüfen Sie die relativen Informationen der letzten 24 Stunden, einschließlich Gesamtleistung (kW), Strom (Ampere), Spannung, Durchschnittstemperatur und Luftfeuchtigkeit, wie in Abbildung 1-17 dargestellt



Abbildung 1-17

### 3.2.1.6. Protokolle

Klicken Sie in der Navigationsleiste auf "**Logs**", um die Logs-Oberfläche zu öffnen (siehe Abbildung 1-18). Siehe auch Abbildung 1-19 und 1-20

Logs Record: zeigt die Betriebszeit, den Log-Typ, den Benutzernamen und die Log-Details. Speicherkapazität 100M.

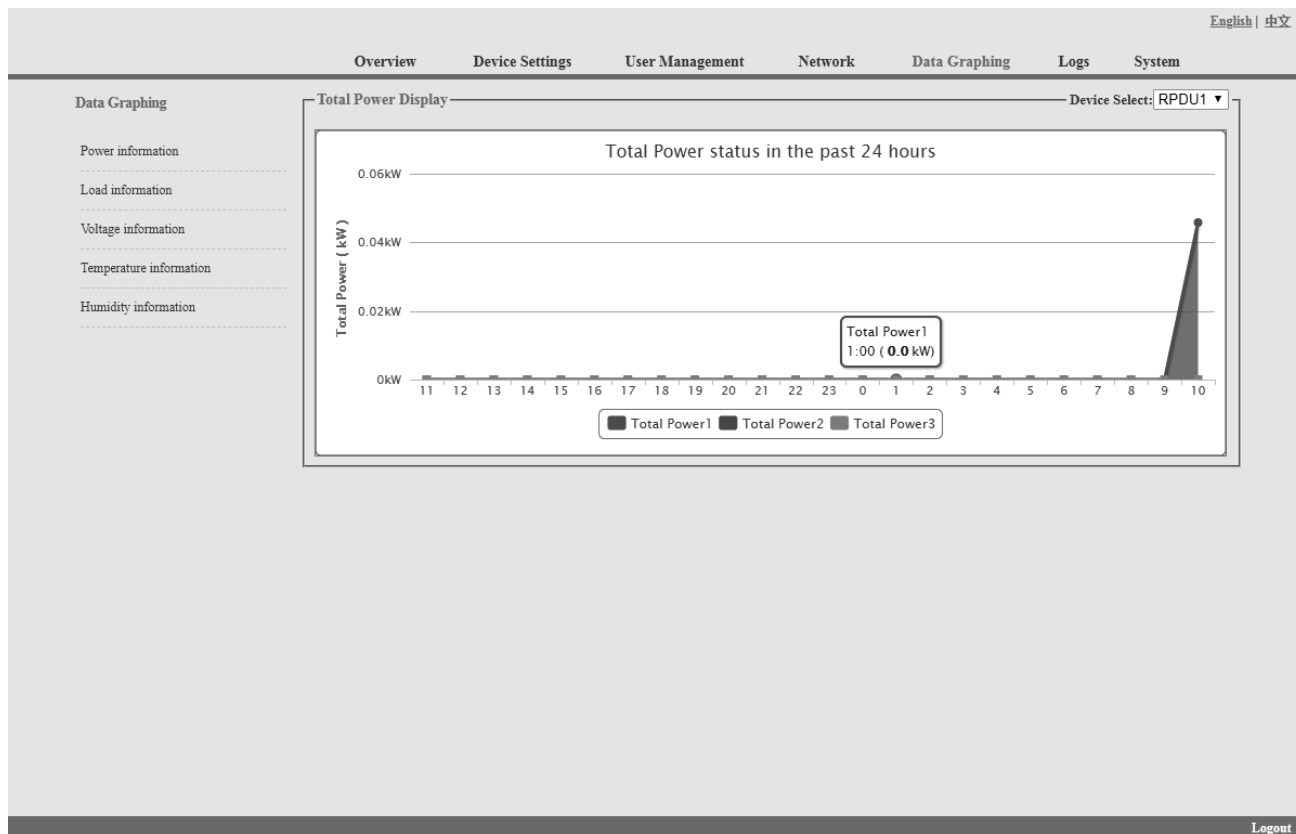
So zeigen Sie die Daten an:

Springen: Geben Sie die Seite ein, die Sie ansehen möchten, und es wird auf die entsprechende Seite umgeschaltet.

Blättern: durch Klicken auf Weiter oder Zurück, um die Protokolle anzuzeigen

Löschen der Protokolle:

Klicken Sie auf "**Protokolle löschen**", das Gerät gibt eine Bestätigung zurück und klickt auf OK, um alle Protokolle zu löschen.

## Logs

Logs Record

History Data

Energy Record

## Logs

Item	Time	Type	Name	Details
1	2018-02-03 15:46	User Login	admin	Login Success.
2	2018-02-03 15:45	User Login	admin	Login Success.
3	2018-02-03 15:45	System Command	admin	Restore to default setting.
4	2018-02-03 15:44	User Login	admin	Login Success.
5	2018-02-03 15:43	User Login	admin	Login Success.
6	2018-02-03 15:43	System Command	admin	Restart Device.
7	2018-02-03 15:43	Device configuration	admin	Network configuration was successfully modified.
8	2018-02-03 15:42	User Login	admin	Login Success.
9	2018-02-03 14:34	User Login	admin	Login Success.
10	2018-02-03 14:32	User Login	admin	Login Success.
11	2018-02-02 13:05	Timing switch	admin	RPDU1->Output1 Timing switch setting.
12	2018-02-02 13:05	Timing switch	admin	RPDU1->Output1 Timing switch setting.
13	2018-02-02 13:00	Timing switch	admin	RPDU1->Output1 Timing switch setting.
14	2018-02-02 13:00	Timing switch	admin	RPDU1->Output1 Timing switch setting.
15	2018-02-02 12:59	Timing switch	admin	RPDU1->Output1 Timing switch setting.

Logs size:12KB Page  of 12

Logout

Abbildung 1-18

Verlaufsdaten: Wählen Sie das Datum, das Gerät und den Informationstyp (Gesamtleistung, Spannung, Leistung, Temperatur und Luftfeuchtigkeit) aus, den Sie anzeigen möchten, und klicken Sie dann auf "Anzeigen", um die Verlaufsdaten zu sehen. Abbildung 1-19 zeigt den Spannungsstatus von 24 Stunden:



Abbildung 1-19

Energieaufzeichnung: Wählen Sie das Gerät, das Start- und Enddatum und klicken Sie auf "Anzeigen". Das System zeigt den akkumulierten kWh-Wert an den beiden Daten an und berechnet den kWh-Wert während dieses Zeitraums, wie in Abbildung 1-20 gezeigt:

English | 中文

Overview    Device Settings    User Management    Network    Data Graphing    Logs    System

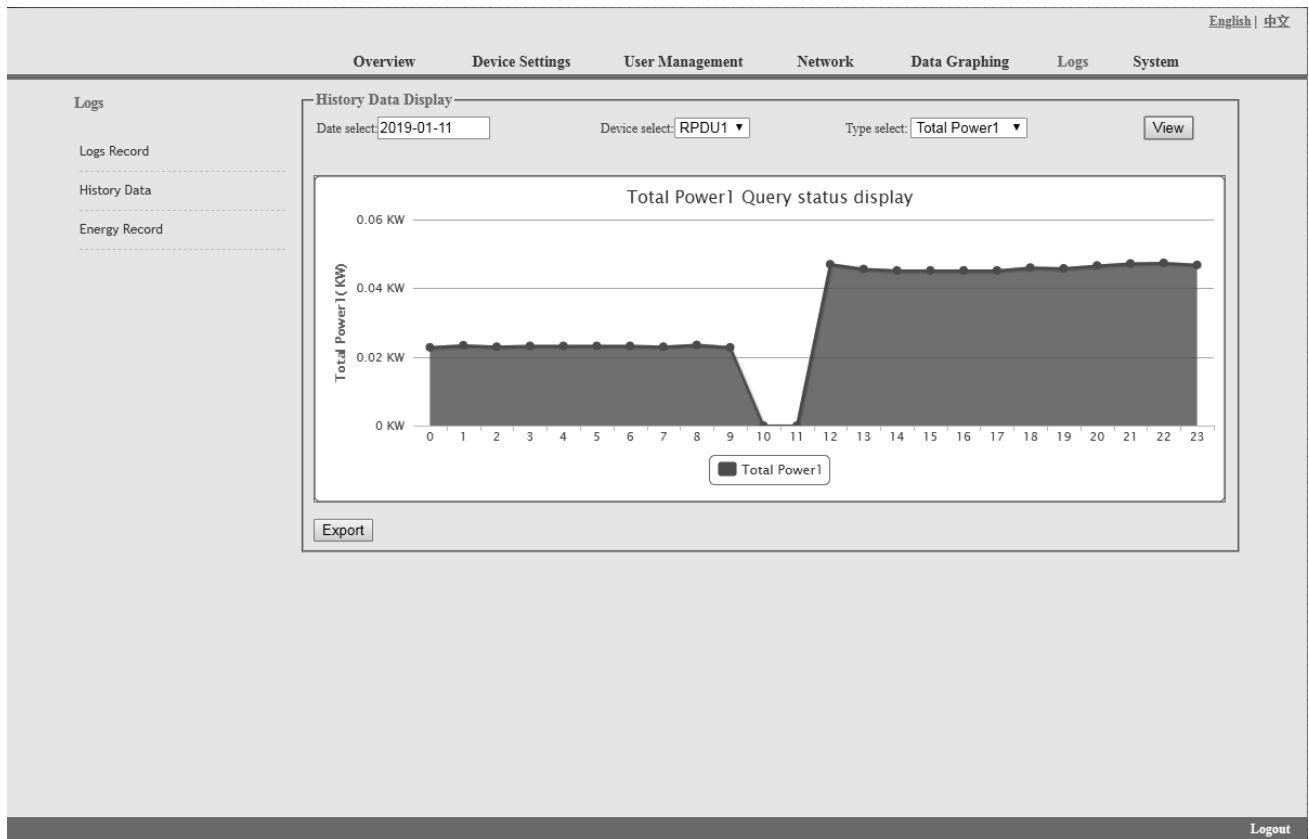
Logs

Logs Record

History Data

Energy Record

Energy Recording Display

Start:     End:     Device select: RPDU1 ▼       

Item	Name	Start recording(kWh)	End of record(kWh)	Electric energy consumption(kWh)
1	Output1	0.0	0.0	0
2	Output2	0.0	0.0	0
3	Output3	0.0	0.0	0
4	Output4	0.0	0.0	0
5	Output5	0.0	0.0	0
6	Output6	0.0	0.0	0
7	Output7	0.0	0.0	0
8	Output8	0.0	0.0	0
9	Output9	0.0	0.0	0
10	Output10	0.0	0.0	0
11	Output11	0.0	0.0	0
12	Output12	0.0	0.0	0
13	Output13	0.0	0.0	0
14	Output14	0.0	0.0	0
15	Output15	0.0	0.0	0
16	Output16	0.0	0.0	0
17	Output17	0.0	0.0	0
18	Output18	0.0	0.0	0
19	Output19	0.0	0.0	0
20	Output20	0.0	0.0	0
21	Output21	0.0	0.0	0
22	Output22	0.0	0.0	0
23	Output23	0.0	0.0	0
24	Output24	0.0	0.0	0

Logout

Abbildung 1-20

### 3.2.1.7. System

Klicken Sie in der Navigationsleiste auf **System**, um die Systemoberfläche aufzurufen, wie in Abbildung 1-21 dargestellt

1. Zeigt Systeminformationen an: Der Benutzer kann die Systemversion, das Datum der letzten Aktualisierung, die Flash-Größe und so weiter überprüfen;
2. Update-Tool herunterladen, um die mitgelieferte Software aus der Ferne zu aktualisieren;
3. Herunterladen des Benutzerhandbuchs und der MIB-Datei ;
4. Massive Datensicherung und schnelle Einrichtung von Massen-PDUs: Klicken Sie auf "Einstellungen", um die Geräteeinstellungen, Benutzereinstellungen und Netzwerkeinstellungen per Batch-Download zu sichern.
5. Benutzer können die Softwareversion einfach über die mitgelieferte Rootfs.bin-Datei aktualisieren, indem sie die Anweisungen zum Hochladen der Software befolgen.  
**Hinweis: Bitte stellen Sie sicher, dass die PDU direkt mit dem PC verbunden ist. Stellen Sie sicher, dass während des Upgrades kein Strom abgeschaltet, keine Netzwerkverbindung unterbrochen und kein Betrieb durchgeführt wird.**
6. Starten Sie die Software neu oder stellen Sie die Werkskonfiguration über die **Systembefehle** wieder her.



Abbildung 1-21

### 3.2.2 SNMP-Zugriff

Diese Software unterstützt SNMP V1, V2C und V3, eine MIB-Datei kann auf Wunsch des Kunden bereitgestellt werden. Der Benutzer kann die Stromversorgungsinformationen und den Umgebungsstatus anzeigen und die Alarmmeldungen vom Gerät empfangen.

Nach der Aktivierung der SNMP-Funktion über die Weboberfläche, muss eine SNMP-Verwaltungssoftware installiert werden (das erste Gerät kann das Master-Gerät oder das Slave-Gerät sein, und die anderen sind alle Slave-Geräte).

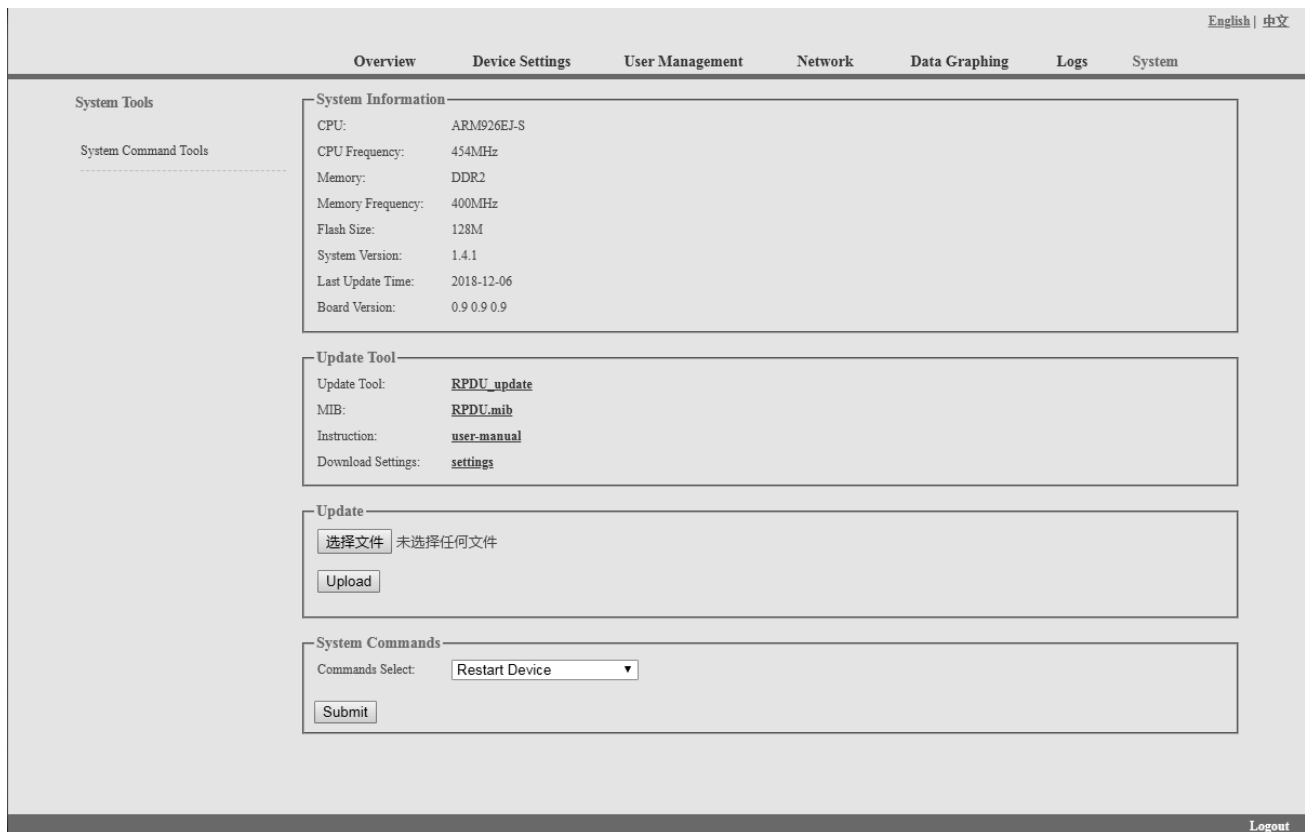
Bitte beachten Sie die OID-Tabelle wie unten:

	OID	Beschreibung
SMART PDUSlave X	1.3.6.1.4.1.30966.6.X	Device X
slave X Name	1.3.6.1.4.1.30966.6.X.1.1	Name of device X
slave X Type	1.3.6.1.4.1.30966.6.X.1.2	Type of device X
slave X Line One	1.3.6.1.4.1.30966.6.X.1.3	Phase one of device X
slave X Line One Power	1.3.6.1.4.1.30966.6.X.1.3.1	Power of phase one of device X
slave X Line One PF	1.3.6.1.4.1.30966.6.X.1.3.2	Power factor of the phase one of device X
slave X Line One Energy	1.3.6.1.4.1.30966.6.X.1.3.3	Energy of phase one of device X
slave X Line One Current	1.3.6.1.4.1.30966.6.X.1.3.4	Current of phase one of device X
slave X Line One Voltage	1.3.6.1.4.1.30966.6.X.1.3.5	voltage of phase one of device X

slave X Line One Current Min	1.3.6.1.4.1.30966.6.X.1.3.6	Minimum Current of phase one of device X
slave X Line One Current Max	1.3.6.1.4.1.30966.6.X.1.3.7	Maximum Current of phase one of device X
slave X Line One Voltage Min	1.3.6.1.4.1.30966.6.X.1.3.8	Minimum voltage of phase one of device X
slave X Line One Voltage Max	1.3.6.1.4.1.30966.6.X.1.3.9	Maximum voltage of phase one of device X
slave X Line Two	1.3.6.1.4.1.30966.6.X.1.4	Phase two of device X
slave X Line Two Power	1.3.6.1.4.1.30966.6.X.1.4.1	Power of phase two of device X
slave X Line Two PF	1.3.6.1.4.1.30966.6.X.1.4.2	Power factor of the phase two of device X
slave X Line Two Energy	1.3.6.1.4.1.30966.6.X.1.4.3	Energy of phase two of device X
slave X Line Two Current	1.3.6.1.4.1.30966.6.X.1.4.4	Current of phase two of device X
slave X Line Two Voltage	1.3.6.1.4.1.30966.6.X.1.4.5	voltage of phase two of device X
slave X Line Two Current Min	1.3.6.1.4.1.30966.6.X.1.4.6	Minimum Current of phase two of device X
slave X Line Two Current Max	1.3.6.1.4.1.30966.6.X.1.4.7	Maximum Current of phase two of device X
slave X Line Two Voltage Min	1.3.6.1.4.1.30966.6.X.1.4.8	Minimum voltage of phase two of device X
slave X Line Two Voltage Max	1.3.6.1.4.1.30966.6.X.1.4.9	Maximum voltage of phase two of device X
slave X Line Three	1.3.6.1.4.1.30966.6.X.1.5	Phase three of device X
slave X Line Three Power	1.3.6.1.4.1.30966.6.X.1.5.1	Power of phase three of device X
slave X Line Three PF	1.3.6.1.4.1.30966.6.X.1.5.2	Power factor of the phase three of device X
slave X Line Three Energy	1.3.6.1.4.1.30966.6.X.1.5.3	Energy of phase three of device X
slave X Line Three Current	1.3.6.1.4.1.30966.6.X.1.5.4	Current of phase three of device X
slave X Line Three Voltage	1.3.6.1.4.1.30966.6.X.1.5.5	voltage of phase three of device X
slave X Line Three Current Min	1.3.6.1.4.1.30966.6.X.1.5.6	Minimum Current of phase three of device X
slave X Line Three Current Max	1.3.6.1.4.1.30966.6.X.1.5.7	Maximum Current of phase three of device X
slave X Line Three Voltage Min	1.3.6.1.4.1.30966.6.X.1.5.8	Minimum voltage of phase three of device X
slave X Line Three Voltage Max	1.3.6.1.4.1.30966.6.X.1.5.9	Maximum voltage of phase three of device X
slave X Temp Hum	1.3.6.1.4.1.30966.6.X.1.6	The temperature and humidity of device X
slave X Temp One	1.3.6.1.4.1.30966.6.X.1.6.1	The temperature one of device X
slave X Temp Two	1.3.6.1.4.1.30966.6.X.1.6.2	The temperature two of device X
slave X Temp Three	1.3.6.1.4.1.30966.6.X.1.6.3	The temperature three of device X

slave X Temp Four	1.3.6.1.4.1.30966.6.X.1.6.4	The temperature four of device X
slave X Hum One	1.3.6.1.4.1.30966.6.X.1.6.5	The humidity one of device X
slave X Hum Two	1.3.6.1.4.1.30966.6.X.1.6.6	The humidity two of device X
slave X Hum Three	1.3.6.1.4.1.30966.6.X.1.6.7	The humidity three of device X
slave X Hum Four	1.3.6.1.4.1.30966.6.X.1.6.8	The humidity four of device X
slave X Door One	1.3.6.1.4.1.30966.6.X.1.6.9	The door one of device X
slave X Door Two	1.3.6.1.4.1.30966.6.X.1.6.10	The door two of device X
slave X Smoke	1.3.6.1.4.1.30966.6.X.1.6.11	The smoke of device X
slave X Water	1.3.6.1.4.1.30966.6.X.1.6.12	The water of device X
slave X Output Number	1.3.6.1.4.1.30966.6.X.1.7	The outlet quantity of device X
slave X Output Name	1.3.6.1.4.1.30966.6.X.1.8	The outlet name of device X
slave X Output Name One	1.3.6.1.4.1.30966.6.X.1.8.1	The name of outlet 1 of device X
slave X Output Name Two	1.3.6.1.4.1.30966.6.X.1.8.2	The name of outlet 2 of device X
slave X Output Name Three	1.3.6.1.4.1.30966.6.X.1.8.3	The name of outlet 3 of device X
slave X Output Name Four	1.3.6.1.4.1.30966.6.X.1.8.4	The name of outlet 4 of device X
slave X Output Name Five	1.3.6.1.4.1.30966.6.X.1.8.5	The name of outlet 5 of device X
slave X Output Name Six	1.3.6.1.4.1.30966.6.X.1.8.6	The name of outlet 6 of device X
slave X Output Name Seven	1.3.6.1.4.1.30966.6.X.1.8.7	The name of outlet 7 of device X
slave X Output Name Eight	1.3.6.1.4.1.30966.6.X.1.8.8	The name of outlet 8 of device X
slave X Output Name Nine	1.3.6.1.4.1.30966.6.X.1.8.9	The name of outlet 9 of device X
slave X Output Name Ten	1.3.6.1.4.1.30966.6.X.1.8.10	The name of outlet 10 of device X
slave X Output Name Eleven	1.3.6.1.4.1.30966.6.X.1.8.11	The name of outlet 11 of device X
slave X Output Name Twelve	1.3.6.1.4.1.30966.6.X.1.8.12	The name of outlet 12 of device X
slave X Output Name Thirteen	1.3.6.1.4.1.30966.6.X.1.8.13	The name of outlet 13 of device X
slave X Output Name Fourteen	1.3.6.1.4.1.30966.6.X.1.8.14	The name of outlet 14 of device X
slave X Output Name Fifteen	1.3.6.1.4.1.30966.6.X.1.8.15	The name of outlet 15 of device X
slave X Output Name Sixteen	1.3.6.1.4.1.30966.6.X.1.8.16	The name of outlet 16 of device X
slave X Output Name Seventeen	1.3.6.1.4.1.30966.6.X.1.8.17	The name of outlet 17 of device X
slave X Output Name Eighteen	1.3.6.1.4.1.30966.6.X.1.8.18	The name of outlet 18 of device X
slave X Output Name Nineteen	1.3.6.1.4.1.30966.6.X.1.8.19	The name of outlet 19 of device X
slave X Output Name Twenty	1.3.6.1.4.1.30966.6.X.1.8.20	The name of outlet 20 of device X
slave X Output Name Twenty One	1.3.6.1.4.1.30966.6.X.1.8.21	The name of outlet 21 of device X
slave X Output Name Twenty Two	1.3.6.1.4.1.30966.6.X.1.8.22	The name of outlet 22 of device X
slave X Output Name Twenty Three	1.3.6.1.4.1.30966.6.X.1.8.23	The name of outlet 23 of device X
slave X Output Name Twenty Four	1.3.6.1.4.1.30966.6.X.1.8.24	The name of outlet 24 of device X
slave X Output Status	1.3.6.1.4.1.30966.6.X.1.9	The outlet status of device X
slave X Output Status One	1.3.6.1.4.1.30966.6.X.1.9.1	The outlet 1 status of device X
slave X Output Status Two	1.3.6.1.4.1.30966.6.X.1.9.2	The outlet 2 status of device X
slave X Output Status Three	1.3.6.1.4.1.30966.6.X.1.9.3	The outlet 3 status of device X
slave X Output Status Four	1.3.6.1.4.1.30966.6.X.1.9.4	The outlet 4 status of device X
slave X Output Status Five	1.3.6.1.4.1.30966.6.X.1.9.5	The outlet 5 status of device X
slave X Output Status Six	1.3.6.1.4.1.30966.6.X.1.9.6	The outlet 6 status of device X
slave X Output Status Seven	1.3.6.1.4.1.30966.6.X.1.9.7	The outlet 7 status of device X

slave X Output Status Eight	1.3.6.1.4.1.30966.6.X.1.9.8	The outlet 8 status of device X
slave X Output Status Nine	1.3.6.1.4.1.30966.6.X.1.9.9	The outlet 9 status of device X
slave X Output Status Ten	1.3.6.1.4.1.30966.6.X.1.9.10	The outlet 10status of device X
slave X Output Status Eleven	1.3.6.1.4.1.30966.6.X.1.9.11	The outlet 11 status of device X
slave X Output Status Twelve	1.3.6.1.4.1.30966.6.X.1.9.12	The outlet 12 status of device X
slave X Output Status Thirteen	1.3.6.1.4.1.30966.6.X.1.9.13	The outlet 13 status of device X
slave X Output Status Fourteen	1.3.6.1.4.1.30966.6.X.1.9.14	The outlet 14 status of device X
slave X Output Status Fifteen	1.3.6.1.4.1.30966.6.X.1.9.15	The outlet 15 status of device X
slave X Output Status Sixteen	1.3.6.1.4.1.30966.6.X.1.9.16	The outlet 16 status of device X
slave X Output Status Seventeen	1.3.6.1.4.1.30966.6.X.1.9.17	The outlet 17 status of device X
slave X Output Status Eighteen	1.3.6.1.4.1.30966.6.X.1.9.18	The outlet 18 status of device X
slave X Output Status Nineteen	1.3.6.1.4.1.30966.6.X.1.9.19	The outlet 19 status of device X
slave X Output Status Twenty	1.3.6.1.4.1.30966.6.X.1.9.20	The outlet 20 status of device X
slave X Output Status Twenty One	1.3.6.1.4.1.30966.6.X.1.9.21	The outlet 21 status of device X
slave X Output Status Twenty Two	1.3.6.1.4.1.30966.6.X.1.9.22	The outlet 22 status of device X
slave X Output Status Twenty Three	1.3.6.1.4.1.30966.6.X.1.9.23	The outlet 23 status of device X
slave X Output Current	1.3.6.1.4.1.30966.6.X.1.10	The outlet current of device X
slave X Output Current One	1.3.6.1.4.1.30966.6.X.1.10.1	The current of outlet 1 of device X
slave X Output Current Two	1.3.6.1.4.1.30966.6.X.1.10.2	The current of outlet 2 of device X
slave X Output Current Three	1.3.6.1.4.1.30966.6.X.1.10.3	The current of outlet 3 of device X
slave X Output Current Four	1.3.6.1.4.1.30966.6.X.1.10.4	The current of outlet 4 of device X
slave X Output Current Five	1.3.6.1.4.1.30966.6.X.1.10.5	The current of outlet 5 of device X
slave X Output Current Six	1.3.6.1.4.1.30966.6.X.1.10.6	The current of outlet 6 of device X
slave X Output Current Seven	1.3.6.1.4.1.30966.6.X.1.10.7	The current of outlet 7 of device X
slave X Output Current Eight	1.3.6.1.4.1.30966.6.X.1.10.8	The current of outlet 8 of device X
slave X Output Current Nine	1.3.6.1.4.1.30966.6.X.1.10.9	The current of outlet 9 of device X
slave X Output Current Ten	1.3.6.1.4.1.30966.6.X.1.10.10	The current of outlet 10 of device X
slave X Output Current Eleven	1.3.6.1.4.1.30966.6.X.1.10.11	The current of outlet 11 of device X
slave X Output Current Twelve	1.3.6.1.4.1.30966.6.X.1.10.12	The current of outlet 12 of device X
slave X Output Current Thirteen	1.3.6.1.4.1.30966.6.X.1.10.13	The current of outlet 13 of device X
slave X Output Current Fourteen	1.3.6.1.4.1.30966.6.X.1.10.14	The current of outlet 14 of device X
slave X Output Current Fifteen	1.3.6.1.4.1.30966.6.X.1.10.15	The current of outlet 15 of device X
slave X Output Current Sixteen	1.3.6.1.4.1.30966.6.X.1.10.16	The current of outlet 16 of device X
slave X Output Current Seventeen	1.3.6.1.4.1.30966.6.X.1.10.17	The current of outlet 17 of device X



slave X Output Current Eighteen	1.3.6.1.4.1.30966.6.X.1.10.18	The current of outlet 18 of device X
slave X Output Current Nineteen	1.3.6.1.4.1.30966.6.X.1.10.19	The current of outlet 19 of device X
slave X Output Current Twenty	1.3.6.1.4.1.30966.6.X.1.10.20	The current of outlet 20 of device X
slave X Output Current Twenty One	1.3.6.1.4.1.30966.6.X.1.10.21	The current of outlet 21 of device X
slave X Output Current Twenty Two	1.3.6.1.4.1.30966.6.X.1.10.22	The current of outlet 22 of device X
slave X Output Current Twenty Three	1.3.6.1.4.1.30966.6.X.1.10.23	The current of outlet 23 of device X
slave X Output Current Twenty Four	1.3.6.1.4.1.30966.6.X.1.10.24	The current of outlet 24 of device X
slave X Output Current Min	1.3.6.1.4.1.30966.6.X.1.11	The outlet Minimum current of device X
slave X Output Current Min One	1.3.6.1.4.1.30966.6.X.1.11.1	The Minimum current of outlet 1 of device X
slave X Output Current Min Two	1.3.6.1.4.1.30966.6.X.1.11.2	The Minimum current of outlet 2 of device X
slave X Output Current Min Three	1.3.6.1.4.1.30966.6.X.1.11.3	The Minimum current of outlet 3 of device X
slave X Output Current Min Four	1.3.6.1.4.1.30966.6.X.1.11.4	The Minimum current of outlet 4 of device X
slave X Output Current Min Five	1.3.6.1.4.1.30966.6.X.1.11.5	The Minimum current of outlet 5 of device X
slave X Output Current Min Six	1.3.6.1.4.1.30966.6.X.1.11.6	The Minimum current of outlet 6 of device X
slave X Output Current Min Seven	1.3.6.1.4.1.30966.6.X.1.11.7	The Minimum current of outlet 7 of device X
slave X Output Current Min Eight	1.3.6.1.4.1.30966.6.X.1.11.8	The Minimum current of outlet 8 of device X
slave X Output Current Min Nine	1.3.6.1.4.1.30966.6.X.1.11.9	The Minimum current of outlet 9 of device X
slave X Output Current Min Ten	1.3.6.1.4.1.30966.6.X.1.11.10	The Minimum current of outlet 10 of device X
slave X Output Current Min Eleven	1.3.6.1.4.1.30966.6.X.1.11.11	The Minimum current of outlet 11 of device X
slave X Output Current Min Twelve	1.3.6.1.4.1.30966.6.X.1.11.12	The Minimum current of outlet 12 of device X
slave X Output Current Min Thirteen	1.3.6.1.4.1.30966.6.X.1.11.13	The Minimum current of outlet 13 of device X
slave X Output Current Min Fourteen	1.3.6.1.4.1.30966.6.X.1.11.14	The Minimum current of outlet 14 of device X

slave X Output Current Min Fifteen	1.3.6.1.4.1.30966.6.X.1.11.15	The Minimum current of outlet 15 of device X
slave X Output Current Min Sixteen	1.3.6.1.4.1.30966.6.X.1.11.16	The Minimum current of outlet 16 of device X
slave X Output Current Min Seventeen	1.3.6.1.4.1.30966.6.X.1.11.17	The Minimum current of outlet 17 of device X
slave X Output Current Min Eighteen	1.3.6.1.4.1.30966.6.X.1.11.18	The Minimum current of outlet 18 of device X
slave X Output Current Min Nineteen	1.3.6.1.4.1.30966.6.X.1.11.19	The Minimum current of outlet 19 of device X
slave X Output Current Min Twenty	1.3.6.1.4.1.30966.6.X.1.11.20	The Minimum current of outlet 20 of device X
slave X Output Current Min Twenty One	1.3.6.1.4.1.30966.6.X.1.11.21	The Minimum current of outlet 21 of device X
slave X Output Current Min Twenty Two	1.3.6.1.4.1.30966.6.X.1.11.22	The Minimum current of outlet 22 of device X
slave X Output Current Min Twenty Three	1.3.6.1.4.1.30966.6.X.1.11.23	The Minimum current of outlet 23 of device X
slave X Output Current Min Twenty Four	1.3.6.1.4.1.30966.6.X.1.11.24	The Minimum current of outlet 24 of device X
slave X Output Current Max	1.3.6.1.4.1.30966.6.X.1.12	The Minimum outlet current of device X
slave X Output Current Max One	1.3.6.1.4.1.30966.6.X.1.12.1	The Maximum current of outlet 1 of device X
slave X Output Current Max Two	1.3.6.1.4.1.30966.6.X.1.12.2	The Maximum current of outlet 2 of device X
slave X Output Current Max Three	1.3.6.1.4.1.30966.6.X.1.12.3	The Maximum current of outlet 3 of device X
slave X Output Current Max Four	1.3.6.1.4.1.30966.6.X.1.12.4	The Maximum current of outlet 4 of device X
slave X Output Current Max Five	1.3.6.1.4.1.30966.6.X.1.12.5	The Maximum current of outlet 5 of device X
slave X Output Current Max Six	1.3.6.1.4.1.30966.6.X.1.12.6	The Maximum current of outlet 6 of device X
slave X Output Current Max Seven	1.3.6.1.4.1.30966.6.X.1.12.7	The Maximum current of outlet 7 of device X
slave X Output Current Max Eight	1.3.6.1.4.1.30966.6.X.1.12.8	The Maximum current of outlet 8 of device X
slave X Output Current Max Nine	1.3.6.1.4.1.30966.6.X.1.12.9	The Maximum current of outlet 9 of device X
slave X Output Current Max Ten	1.3.6.1.4.1.30966.6.X.1.12.10	The Maximum current of outlet 10 of device X
slave X Output Current Max Eleven	1.3.6.1.4.1.30966.6.X.1.12.11	The Maximum current of outlet 11 of device X

slave X Output Current Max Twelve	1.3.6.1.4.1.30966.6.X.1.12.12	The Maximum current of outlet 12 of device X
slave X Output Current Max Thirteen	1.3.6.1.4.1.30966.6.X.1.12.13	The Maximum current of outlet 13 of device X
slave X Output Current Max Fourteen	1.3.6.1.4.1.30966.6.X.1.12.14	The Maximum current of outlet 14 of device X
slave X Output Current Max Fifteen	1.3.6.1.4.1.30966.6.X.1.12.15	The Maximum current of outlet 15 of device X
slave X Output Current Max Sixteen	1.3.6.1.4.1.30966.6.X.1.12.16	The Maximum current of outlet 16 of device X
slave X Output Current Max Seventeen	1.3.6.1.4.1.30966.6.X.1.12.17	The Maximum current of outlet 17 of device X
slave X Output Current Max Eighteen	1.3.6.1.4.1.30966.6.X.1.12.18	The Maximum current of outlet 18 of device X
slave X Output Current Max Nineteen	1.3.6.1.4.1.30966.6.X.1.12.19	The Maximum current of outlet 19 of device X
slave X Output Current Max Twenty	1.3.6.1.4.1.30966.6.X.1.12.20	The Maximum current of outlet 20 of device X
slave X Output Current Max Twenty One	1.3.6.1.4.1.30966.6.X.1.12.21	The Maximum current of outlet 21 of device X
slave X Output Current Max Twenty Two	1.3.6.1.4.1.30966.6.X.1.12.22	The Maximum current of outlet 22 of device X
slave X Output Current Max Twenty Three	1.3.6.1.4.1.30966.6.X.1.12.23	The Maximum current of outlet 23 of device X
slave X Output Current Max Twenty Four	1.3.6.1.4.1.30966.6.X.1.12.24	The Maximum current of outlet 24 of device X
slave X Output Current Energy	1.3.6.1.4.1.30966.6.X.1.13	The energy of device X
slave X Output Current Energy One	1.3.6.1.4.1.30966.6.X.1.13.1	The energy of outlet 1 of device X
slave X Output Current Energy Two	1.3.6.1.4.1.30966.6.X.1.13.2	The energy of outlet 2 of device X
slave X Output Current Energy Three	1.3.6.1.4.1.30966.6.X.1.13.3	The energy of outlet 3 of device X
slave X Output Current Energy Four	1.3.6.1.4.1.30966.6.X.1.13.4	The energy of outlet 4 of device X
slave X Output Current Energy Five	1.3.6.1.4.1.30966.6.X.1.13.5	The energy of outlet 5 of device X
slave X Output Current Energy Six	1.3.6.1.4.1.30966.6.X.1.13.6	The energy of outlet 6 of device X
slave X Output Current Energy Seven	1.3.6.1.4.1.30966.6.X.1.13.7	The energy of outlet 7 of device X
slave X Output Current Energy Eight	1.3.6.1.4.1.30966.6.X.1.13.8	The energy of outlet 8 of device X
slave X Output Current Energy Nine	1.3.6.1.4.1.30966.6.X.1.13.9	The energy of outlet 9 of device X
slave X Output Current Energy Ten	1.3.6.1.4.1.30966.6.X.1.13.10	The energy of outlet 10 of device X
slave X Output Current Energy Eleven	1.3.6.1.4.1.30966.6.X.1.13.11	The energy of outlet 11 of device X
slave X Output Current Energy Twelve	1.3.6.1.4.1.30966.6.X.1.13.12	The energy of outlet 12 of device X
slave X Output Current Energy Thirteen	1.3.6.1.4.1.30966.6.X.1.13.13	The energy of outlet 13 of device X
slave X Output Current Energy Fourteen	1.3.6.1.4.1.30966.6.X.1.13.14	The energy of outlet 14 of device X
slave X Output Current Energy Fifteen	1.3.6.1.4.1.30966.6.X.1.13.15	The energy of outlet 15 of device X
slave X Output Current Energy Sixteen	1.3.6.1.4.1.30966.6.X.1.13.16	The energy of outlet 16 of device X

slave X Output Current Energy Seventeen	1.3.6.1.4.1.30966.6.X.1.13.17	The energy of outlet 17 of device X
slave X Output Current Energy Eighteen	1.3.6.1.4.1.30966.6.X.1.13.18	The energy of outlet 18 of device X
slave X Output Current Energy Nineteen	1.3.6.1.4.1.30966.6.X.1.13.19	The energy of outlet 19 of device X
slave X Output Current Energy Twenty	1.3.6.1.4.1.30966.6.X.1.13.20	The energy of outlet 20 of device X
slave X Output Current Energy Twenty One	1.3.6.1.4.1.30966.6.X.1.13.21	The energy of outlet 21 of device X
slave X Output Current Energy Twenty Two	1.3.6.1.4.1.30966.6.X.1.13.22	The energy of outlet 22 of device X
slave X Output Current Energy Twenty Three	1.3.6.1.4.1.30966.6.X.1.13.23	The energy of outlet 23 of device X
slave X Output Current Energy Twenty Four	1.3.6.1.4.1.30966.6.X.1.13.24	The energy of outlet 24 of device X

B. Zum Anzeigen des Geräte- und Sensorstatus im Tabellenformat über die SNMP-Software:  
Tabelle 2-1 Die Tabelle der Ausgangsstatusinformationen

Menü	Beschreibung
SMART PDU Device xx	Device xx
Slave xx line xx	Phase xx of device xx
Slave xx line xx Power	Power of phase xx of device xx
Slave xx line xx PF	Power Factor of phase xx of device xx
Slave xx line xx Energy	Energy of phase xx of device xx
Slave xx line xx Current	Current of phase xx of device xx
Slave xx line xx Voltage	Voltage of phase xx of device xx
Slave xx line xx Current MIN	The Minimum current of phase xx of device xx
Slave xx line xx Current Max	The Maximum current of phase xx of device xx
Slave xx line xx Voltage Min	The Minimum voltage of phase xx of device xx
Slave xx line xx Voltage Max	The Maximum voltage of phase xx of device xx
Slave xx temp	The temperature of device xx
Slave xx hum	The humidity of device xx
Slave xx temp Min	The Minimum temperature value of device xx
Slave xx temp Max	The Maximum temperature value of device xx
Slave xx hum Min	The Minimum humidity value of device xx
Slave xx hum Max	The Maximum humidity value of device xx
Slave xx output name xx	The outlet name of outlet xx of device xx
Slave xx output status xx	The on/off status of outlet xx of device xx
Slave xx output current xx	The current of outlet xx of device xx

Slave xx output current Min xx	The Minimum current of outlet xx of device xx
Slave xx output current Max xx	The Maximum current of outlet xx of device
Slave xx output current Energy xx	The energy of outlet xx of device xx
Slave xx name	The name of device xx
Slave xx Type	The type of device xx
Slave xx output number	The outlet quantity of device xx

### 3.2.3 Telnet-Zugang

Das Gerät unterstützt den Telnet-Zugang. Nach Eingabe des Benutzernamens und des Passworts kann der Benutzer das Gerät aus der Ferne überwachen und verwalten. Der Telnet-Zugang unterstützt auch Daisy-Chain, damit der Benutzer bis zu 5 Geräte verwalten kann.

**3.2.3.1. So öffnen Sie den Telnet-Client**  über Start → Befehl ausführen → "Telnet" in das Eingabefeld eingeben und auf OK klicken

**3.2.3.2. Geben Sie die IP-Adresse wie in Abbildung 2-4 dargestellt ein**



Abbildung 2-4

Geben Sie den Benutzernamen und das Passwort ein, die in Abbildung 2-5 gezeigte Oberfläche wird eingeblendet

```
192.168.1.163 - PuTTY
Welcome to RPDU cmd!
-----
Device Name      : RPDU1
System Version  : 1.4.1
Last Update Time : 2018-12-06
The Current Time : 2019-01-12 10:52
-----
login:admin
password:
-----
order list: status on off set network reboot reset quit
-----
input order:
```

Abbildung 2-5

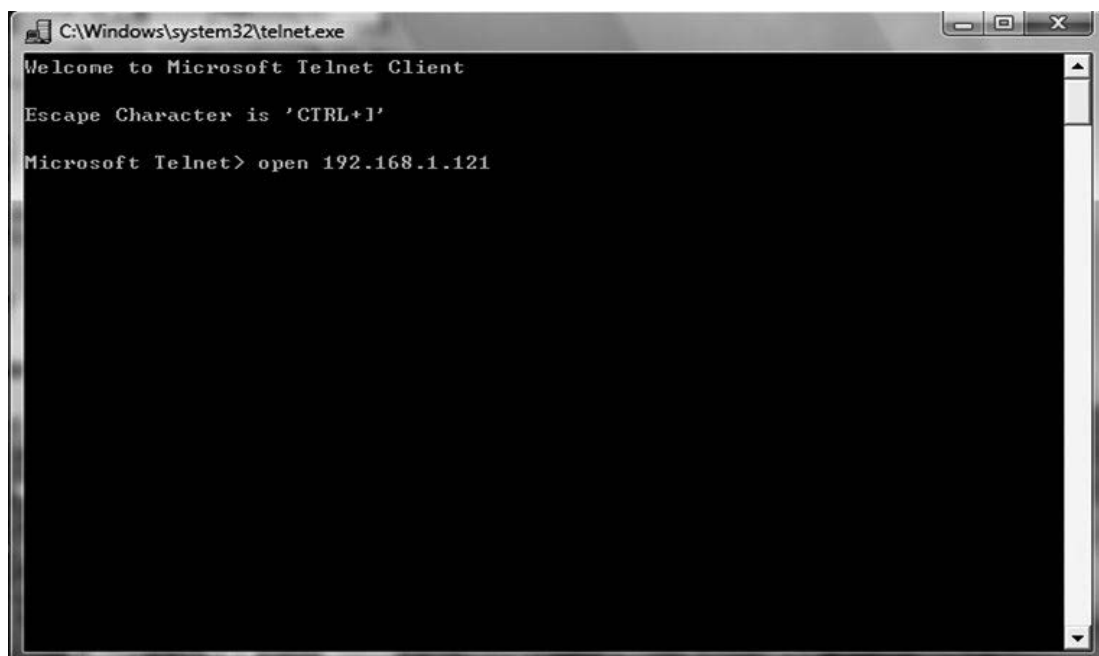
### 3.2.3.3 "STATUS"-Befehl

Geben Sie den Befehl "STATUS" ein, um den Status der einzelnen Ausgänge (einschließlich Strom, Ein-/Aus-Zustand, Max. und Min. Stromwert, kW und kWh) und den Gesamtstatus (einschließlich Gesamtstrom, Spannung, kW und kWh) anzuzeigen.

Befehlszeilenformat: STATUS **【index】** **【operation】** wie in Abbildung 2-6 dargestellt:

```
192.168.1.163 - PuTTY
Welcome to RPDU cmd!
-----
Device Name      : RPDU1
System Version  : 1.4.1
Last Update Time : 2018-12-06
The Current Time : 2019-01-12 10:52
-----
login:admin
password:
-----
order list: status on off set network reboot reset quit
-----
input order:status

status [index] [operation]
index:RPDU slave number,'0' is the master, '1' is the slave one...
operation:'total' is the total status
operation:'sensor' is the sensor status
operation:'all' To view all the output state
operation:'1' is the output1 status ...

input order:
```

Abbildung 2-6

【index】 : Gerätemodus (0-9, 0 ist Master, 1-4 ist Slave) ;

【operation】 : Anzeige der Geräteinformationen, Details wie unten:

【operation】	Beschreibung
Total	<p>Zum Beispiel:</p>  <pre> 192.168.1.239 - PuTTY input order:status 0 total  Device Series:NPM-V(D) Device output bits:24 L1 total current:0.0A L1 total voltage:225V power:0.000kW energy:0.0kWh L2 total current:0.0A L2 total voltage:226V power:0.000kW energy:0.0kWh L3 total current:0.0A L3 total voltage:0V power:0.000kW energy:0.0kWh  input order: </pre> <p>Befehlszeile eingeben---<b>Status 0 gesamt</b>: 0 bedeutet den Master (1-4 bedeutet Slave 1 bis Slave 4), total bedeutet den Gesamtstatus, die obige Abbildung zeigt nach Eingabe von "status 0 total". Die Rückgabeinformationen sind wie oben abgebildet</p>
sensor	 <pre> 192.168.1.239 - PuTTY input order:status 0 sensor  temperature1:--  [--,--]'C      humidity1:--  [--,--]% temperature2:--  [--,--]'C      humidity2:--  [--,--]% temperature3:--  [--,--]'C      humidity3:--  [--,--]% temperature4:--  [--,--]'C      humidity4:--  [--,--]% door1:-- water:-- smoke:--  input order: </pre> <p>Befehlszeile eingeben---<b>Status 0 Sensor</b>: 0 bedeutet das Master-Gerät; 1-4 bedeutet die Slave-Geräte. Die Rückgabeinformationen sind wie oben abgebildet</p>

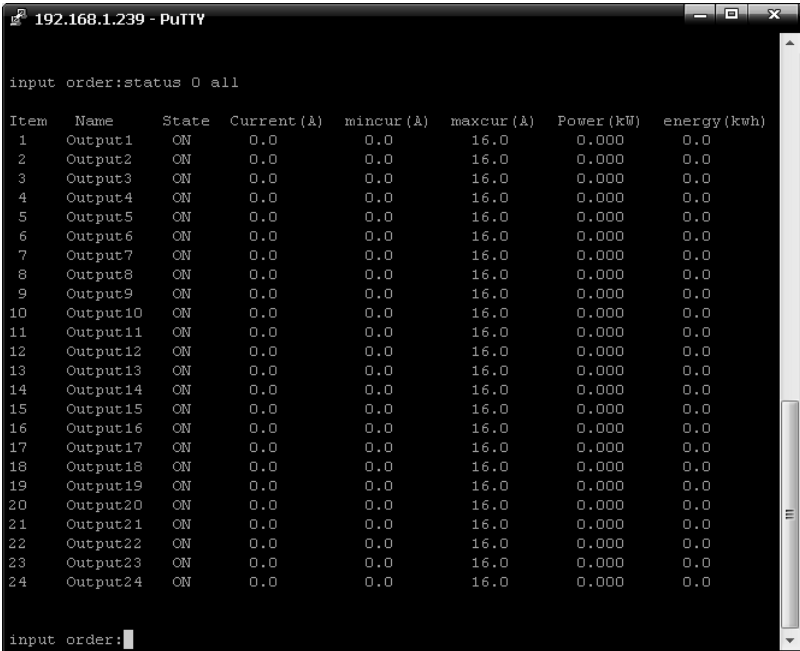
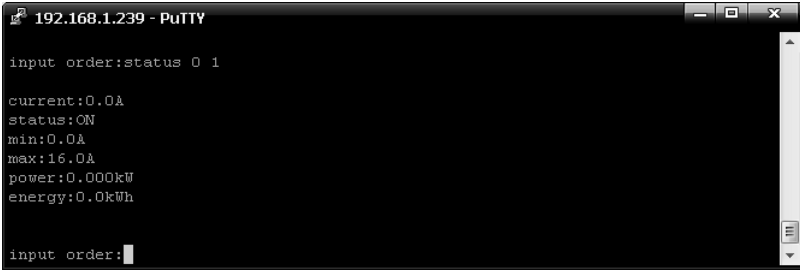
<p style="text-align: center;">all</p>	 <pre> 192.168.1.239 - PuTTY input order:status 0 all  Item  Name      State  Current (A)  mincur (A)  maxcur (A)  Power (kW)  energy (kwh) 1     Output1    ON     0.0          0.0         16.0        0.000      0.0 2     Output2    ON     0.0          0.0         16.0        0.000      0.0 3     Output3    ON     0.0          0.0         16.0        0.000      0.0 4     Output4    ON     0.0          0.0         16.0        0.000      0.0 5     Output5    ON     0.0          0.0         16.0        0.000      0.0 6     Output6    ON     0.0          0.0         16.0        0.000      0.0 7     Output7    ON     0.0          0.0         16.0        0.000      0.0 8     Output8    ON     0.0          0.0         16.0        0.000      0.0 9     Output9    ON     0.0          0.0         16.0        0.000      0.0 10    Output10   ON     0.0          0.0         16.0        0.000      0.0 11    Output11   ON     0.0          0.0         16.0        0.000      0.0 12    Output12   ON     0.0          0.0         16.0        0.000      0.0 13    Output13   ON     0.0          0.0         16.0        0.000      0.0 14    Output14   ON     0.0          0.0         16.0        0.000      0.0 15    Output15   ON     0.0          0.0         16.0        0.000      0.0 16    Output16   ON     0.0          0.0         16.0        0.000      0.0 17    Output17   ON     0.0          0.0         16.0        0.000      0.0 18    Output18   ON     0.0          0.0         16.0        0.000      0.0 19    Output19   ON     0.0          0.0         16.0        0.000      0.0 20    Output20   ON     0.0          0.0         16.0        0.000      0.0 21    Output21   ON     0.0          0.0         16.0        0.000      0.0 22    Output22   ON     0.0          0.0         16.0        0.000      0.0 23    Output23   ON     0.0          0.0         16.0        0.000      0.0 24    Output24   ON     0.0          0.0         16.0        0.000      0.0  input order: </pre> <p>Geben Sie die Befehlszeile---<b>Status 0 all</b> ein, 0 bedeutet das Master-Gerät; 1-4 bedeutet die Slave-Geräte. Die Rückgabeinformationen sind wie oben abgebildet</p>
<p style="text-align: center;">Output</p>	<p>Zum Beispiel:</p>  <pre> 192.168.1.239 - PuTTY input order:status 0 1  current:0.0A status:ON min:0.0A max:16.0A power:0.000kW energy:0.0kWh  input order: </pre> <p>Befehlszeile---<b>Status 0 1</b>: 0 bedeutet den Master (1-4 bedeutet Slave 1 bis Slave 4), 1 bedeutet den Status des ersten Ausgangs, die obige Abbildung wird nach Eingabe von "Status 0 1" angezeigt</p>

### 3.2.3.4 Befehl "ON/OFF"

Der "ON/OFF"-Befehl ermöglicht es dem Benutzer, den einzelnen Ausgang oder das gesamte Gerät ein- bzw. auszuschalten

Befehlsformat: ON/OFF **【index】【operation】** wie in Abbildung 2-7 gezeigt





Abbildung 2-7

【index】 :device mode (0-9, 0 ist Master, 1-4 ist Slave) ;

【operation】 :Anzeige der Geräteinformationen, Details wie unten:

【operation】	Beschreibung
ALL	 <p>Befehlszeile---<b>on 0 all</b> bedeutet, dass alle Ausgänge vom Master-Gerät aus eingeschaltet werden</p>
Output	 <p>Befehlszeile---<b>off 0 1</b> on bedeutet, den ersten Ausgang des Master-Geräts auszuschalten</p>

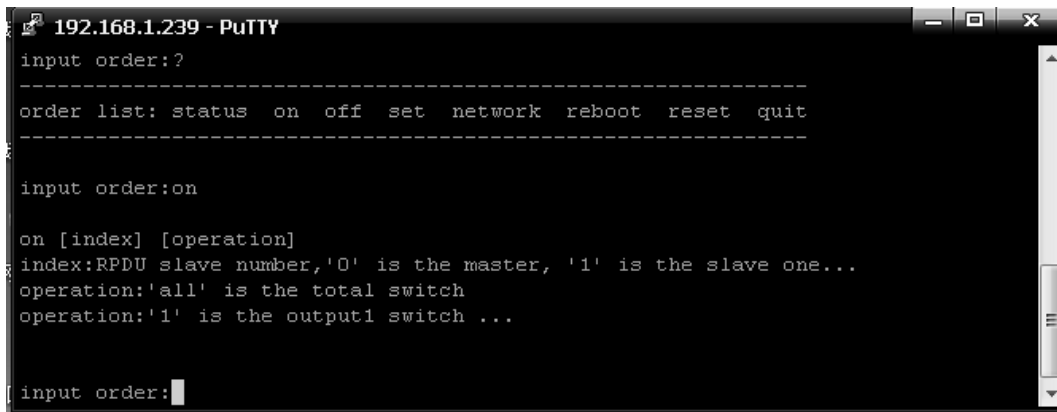
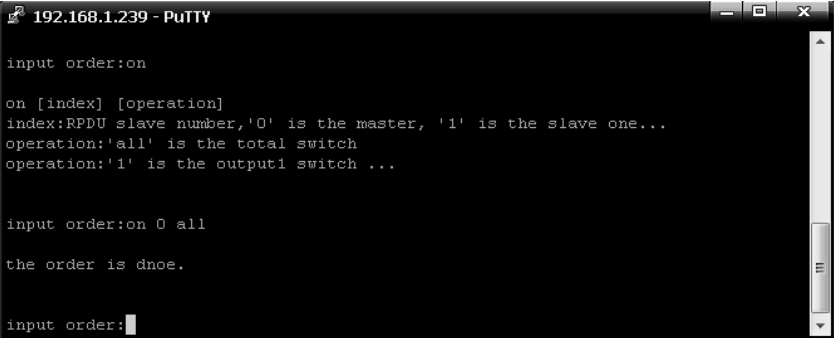
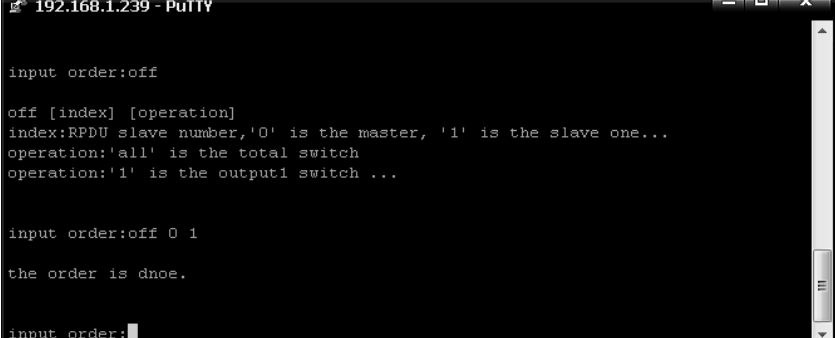
### 3.2.3.5 Befehl "set":

Der Befehl "set" ermöglicht das Einstellen des Stroms der Steckdose, der minimalen und maximalen Temperatur- und Feuchtigkeitsschwelle, das Ändern der IP, Maske, des Gateways, dns, dns1;  
 Befehlsformat: set **【index】** **【operation】** wie in Abbildung 2-8 gezeigt



Abbildung 2-8

**【index】** : Gerätemodus (0-9, 0 ist Master, 1-4 ist Slave);

**【operation】** : Anzeige der Geräteinformationen, Details wie unten:

<b>【operation】</b>	<b>Beschreibung</b>
output	 <p>Befehlszeile---<b>set 0 output1 a1</b> bedeutet, den Ausgang 1 in a1 umzubenennen</p>

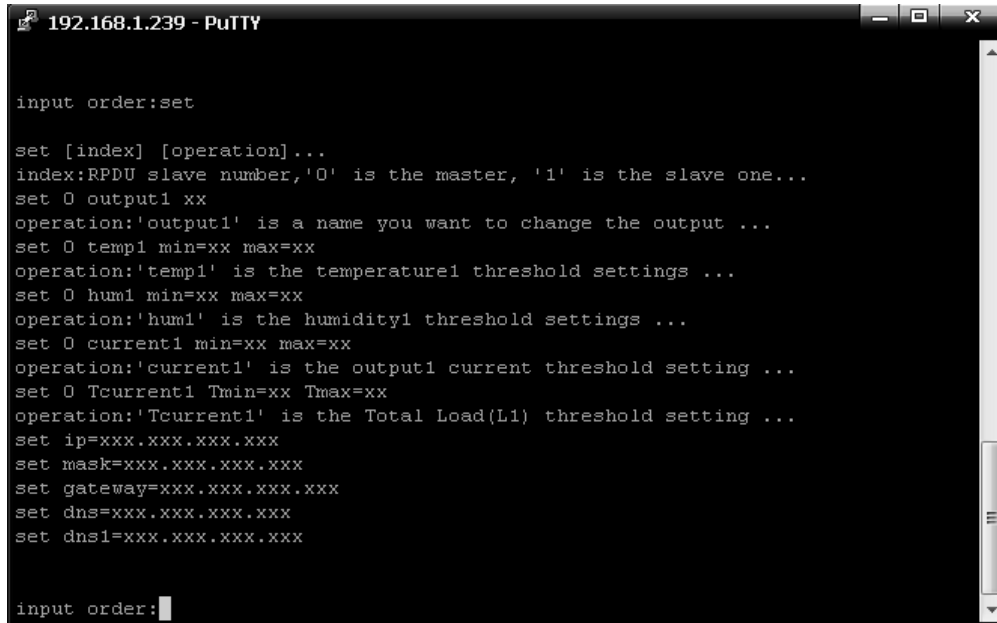
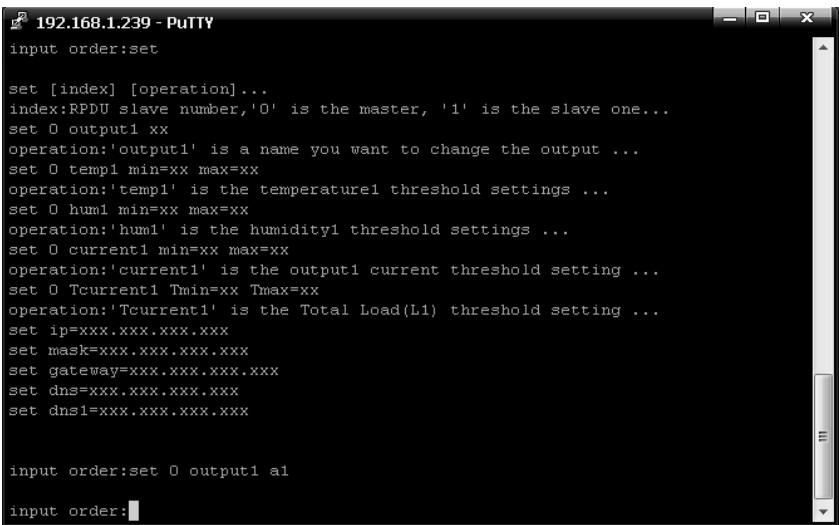
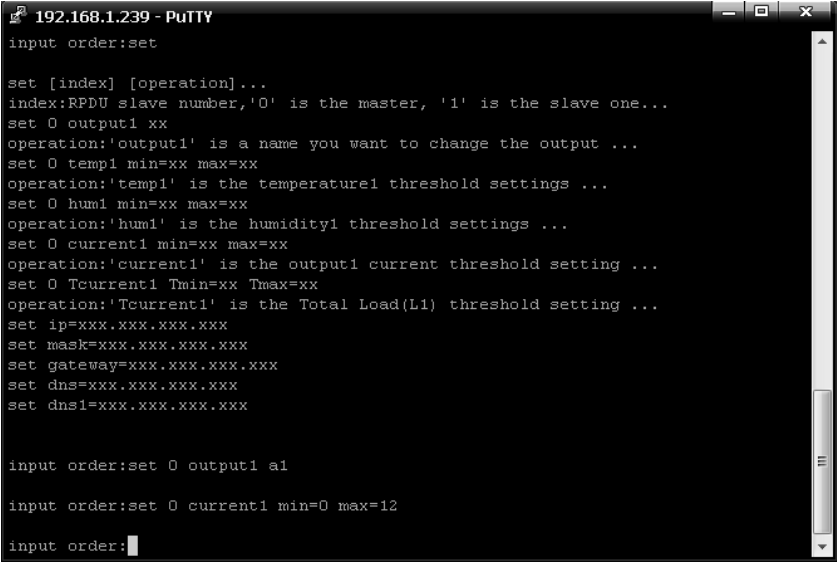
<p>current</p>	 <pre> 192.168.1.239 - PuTTY input order:set  set [index] [operation]... index:RPDU slave number,'0' is the master, '1' is the slave one... set 0 output1 xx operation:'output1' is a name you want to change the output ... set 0 temp1 min=xx max=xx operation:'temp1' is the temperature1 threshold settings ... set 0 hum1 min=xx max=xx operation:'hum1' is the humidity1 threshold settings ... set 0 current1 min=xx max=xx operation:'current1' is the output1 current threshold setting ... set 0 Tcurrent1 Tmin=xx Tmax=xx operation:'Tcurrent1' is the Total Load(L1) threshold setting ... set ip=xxx.xxx.xxx.xxx set mask=xxx.xxx.xxx.xxx set gateway=xxx.xxx.xxx.xxx set dns=xxx.xxx.xxx.xxx set dns1=xxx.xxx.xxx.xxx  input order:set 0 output1 a1  input order:set 0 current1 min=0 max=12  input order: </pre> <p>Befehlszeile--- <b>set 0 current1 min=0 max=12</b> bedeutet, dass der minimale Strom als 0 und der maximale Strom als 12 für Ausgang 1 vom Mastergerät eingestellt wird</p>
----------------	--

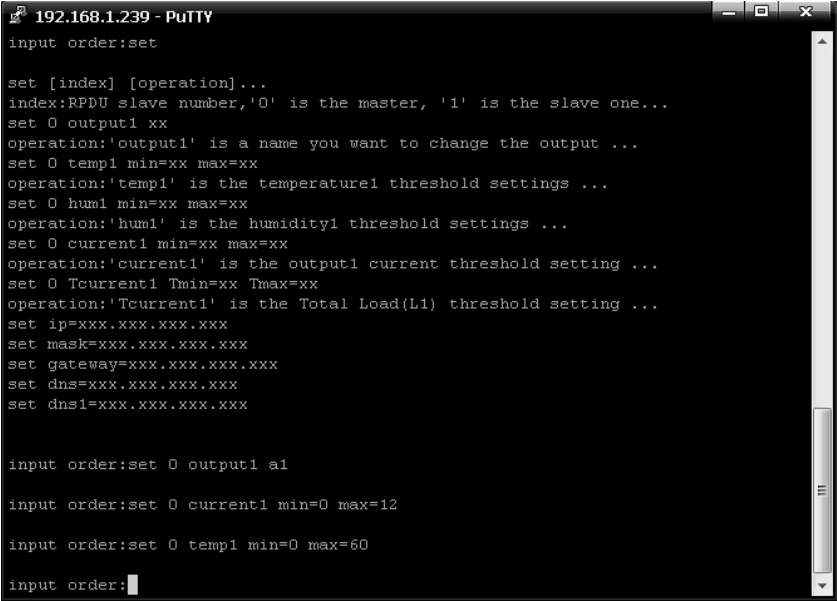
<p>temperature</p>	 <pre> 192.168.1.239 - PuTTY input order:set  set [index] [operation]... index:RPDU slave number,'0' is the master, '1' is the slave one... set 0 output1 xx operation:'output1' is a name you want to change the output ... set 0 temp1 min=xx max=xx operation:'temp1' is the temperature1 threshold settings ... set 0 hum1 min=xx max=xx operation:'hum1' is the humidity1 threshold settings ... set 0 current1 min=xx max=xx operation:'current1' is the output1 current threshold setting ... set 0 Tcurrent1 Tmin=xx Tmax=xx operation:'Tcurrent1' is the Total Load(L1) threshold setting ... set ip=xxx.xxx.xxx.xxx set mask=xxx.xxx.xxx.xxx set gateway=xxx.xxx.xxx.xxx set dns=xxx.xxx.xxx.xxx set dns1=xxx.xxx.xxx.xxx  input order:set 0 output1 a1  input order:set 0 current1 min=0 max=12  input order:set 0 temp1 min=0 max=60  input order: </pre> <p>Befehlszeile--- <b>set 0 temp1 min=0 max=60</b> bedeutet, dass die minimale Temperatur auf 0 Grad und die maximale Temperatur auf 60 Grad für Temperatursensor 1 vom Mastergerät eingestellt wird</p>
--------------------	---

humidity

```
192.168.1.239 - PuTTY
input order:set

set [index] [operation]...
index:RPDU slave number,'0' is the master, '1' is the slave one...
set 0 output1 xx
operation:'output1' is a name you want to change the output ...
set 0 temp1 min=xx max=xx
operation:'temp1' is the temperature1 threshold settings ...
set 0 hum1 min=xx max=xx
operation:'hum1' is the humidity1 threshold settings ...
set 0 current1 min=xx max=xx
operation:'current1' is the output1 current threshold setting ...
set 0 Tcurrent1 Tmin=xx Tmax=xx
operation:'Tcurrent1' is the Total Load(L1) threshold setting ...
set ip=xxx.xxx.xxx.xxx
set mask=xxx.xxx.xxx.xxx
set gateway=xxx.xxx.xxx.xxx
set dns=xxx.xxx.xxx.xxx
set dns1=xxx.xxx.xxx.xxx

input order:set 0 output1 a1

input order:set 0 temp1 min=0 max=60

input order:set 0 hum1 min=0 max=90

input order:set 0 current1 min=0 max=12

input order:set 0 Tcurrent1 Tmin=0 Tmax=16

input order:
```

Befehlszeile--- **set 0 hum1 min=0 max=90** bedeutet, dass die minimale Luftfeuchtigkeit auf 0% und die maximale Luftfeuchtigkeit auf 90% für den Feuchtesensor 1 vom Mastergerät eingestellt wird

Tcurrent

```
192.168.1.239 - PuTTY
input order:set

set [index] [operation]...
index:RPDU slave number,'0' is the master, '1' is the slave one...
set 0 output1 xx
operation:'output1' is a name you want to change the output ...
set 0 temp1 min=xx max=xx
operation:'temp1' is the temperature1 threshold settings ...
set 0 hum1 min=xx max=xx
operation:'hum1' is the humidity1 threshold settings ...
set 0 current1 min=xx max=xx
operation:'current1' is the output1 current threshold setting ...
set 0 Tcurrent1 Tmin=xx Tmax=xx
operation:'Tcurrent1' is the Total Load(L1) threshold setting ...
set ip=xxx.xxx.xxx.xxx
set mask=xxx.xxx.xxx.xxx
set gateway=xxx.xxx.xxx.xxx
set dns=xxx.xxx.xxx.xxx
set dns1=xxx.xxx.xxx.xxx

input order:set 0 output1 a1

input order:set 0 temp1 min=0 max=60

input order:set 0 hum1 min=0 max=90

input order:set 0 current1 min=0 max=12

input order:set 0 Tcurrent1 Tmin=0 Tmax=16

input order:
```

Befehlszeile---**set 0 Tcurrent1 Tmin=0 Tmax=16** bedeutet, dass der minimale Strom als 0A und der maximale Strom als 16A für den Gesamtstrom der Phase A vom Mastergerät eingestellt wird

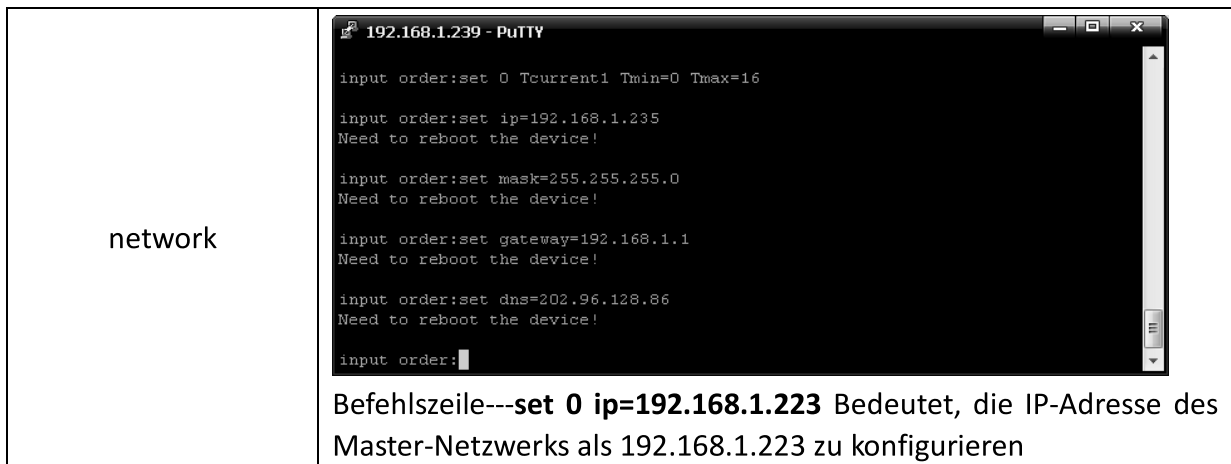

3.2.3.6 Netzwerk-Befehl: Prüfen Sie die Netzwerkkonfigurationsinformationen, wie IP-Adresse, Subnetzmaske, Standard-Gateway, Haupt-DNS, Ersatz-DNS



Abbildung 2-9

3.2.3.7 Reboot-Befehl: um das Gerät neu zu starten, wie in Abbildung 2-10 gezeigt

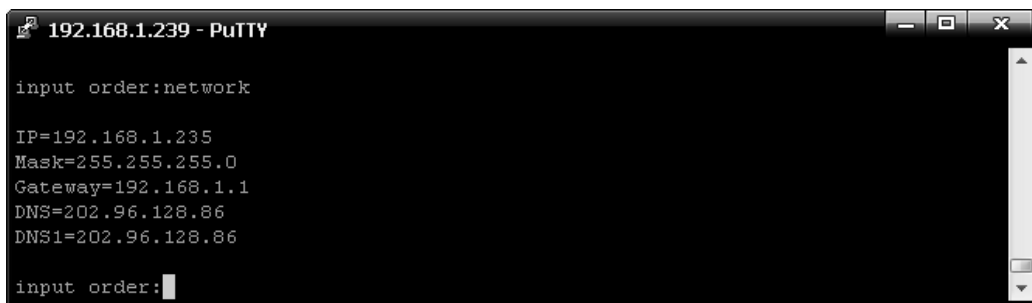

Abbildung 2-10

After type Y and press Enter, exit the telnet interface, and restart device system;  
Type n and press Enter to exit the telnet interface

### 3.2.3.8: RESET-Befehl zum Wiederherstellen der Werkseinstellungen wie in Abbildung 2-11

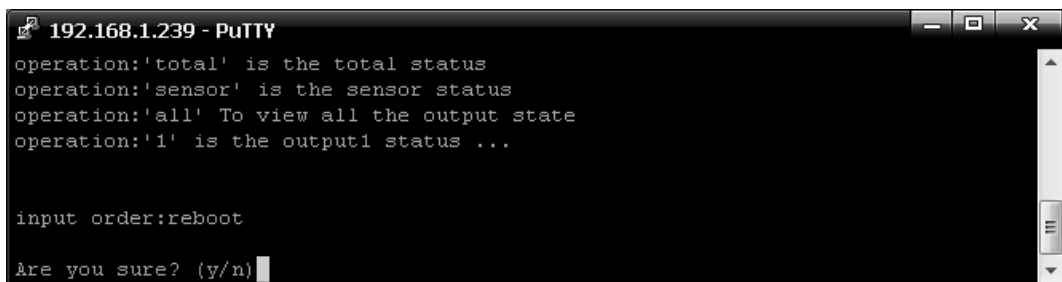
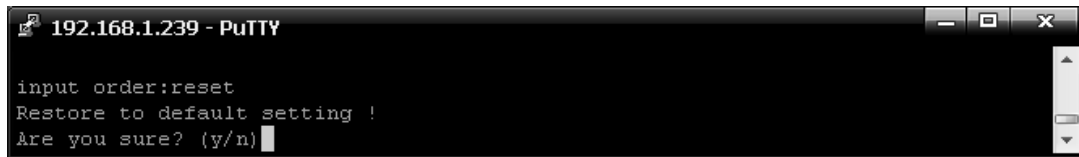

```
192.168.1.239 - PuTTY
input order:reset
Restore to default setting !
Are you sure? (y/n)
```

Abbildung 2-11

### 3.2.3.9: QUIT-Befehl, um den Telnet-Client zu beenden, wie in Abbildung 2-12 gezeigt



```
192.168.1.239 - PuTTY
input order:reset
Restore to default setting !
Are you sure? (y/n) n

input order:quit
Are you sure? (y/n)
```

Abbildung 2-12

Geben Sie y ein, und drücken Sie die Eingabetaste, um die Telnet-Schnittstelle zu beenden. Geben Sie n ein, und drücken Sie die Eingabetaste, um den Vorgang abzubrechen.

## 3.2.4 MODBUS-Zugriff

Für den MODBUS-Zugriff beachten Sie bitte die 《SMART PDU MODBUS RTU Protokollanweisung》

## 4. Häufig gestellte Fragen

### 4.1. Haben Sie die IP-Adresse vergessen?

A: Prüfen Sie auf dem LCD-Bildschirm, auf der ersten Seite wird die IP-Adresse angezeigt

### 4.2. Scheitert das Senden von E-Mails?

- A: 1) Prüfen und bestätigen Sie, dass das Gerät mit dem Netzwerk verbunden ist und das Netzwerk normal funktioniert.
- 2) Überprüfen Sie die DNS-Konfiguration und bestätigen Sie, ob sie erfolgreich ist.
- 3) Prüfen und bestätigen Sie, dass der POP- und SMTP-Server korrekt ist und mit dem Absender-Mailbox-Server übereinstimmt.  
Bitte bestätigen Sie, dass der SMTP-Port korrekt ist.

### 4.3. Verlorene IP

A. Drücken und halten Sie die RESET-Taste für 6 Sekunden, lassen Sie die RESET-Taste los, wenn das Gerät summt, das Gerät wird neu gestartet.

## 5. Technologie-Parameter

No.	Leistungsparameter		Technical parameter
1	Eingang	Nenneingangsspannung	110/220VAC 50/60 Hz; 380 VAC 50/60 Hz;
		Nenneingangsstecker	IEC60309 Standard
		Kabel-Spezifikation	16A:3×2.5mm <sup>2</sup> 32A:3×6.0mm <sup>2</sup> ; 3×16A:5×2.5mm <sup>2</sup> 3×32A:5×6.0mm <sup>2</sup>
		Kabellänge	2.5M
		Max. Laststrom	16A, 32A 3×16A, 3×32A
		Überlastschutz	1P Schutzschalter 3P Schutzschalter
2	Ausgang	Steckdosen-Standard	Standard IEC320 C13, C19
		Anzahl Steckdosen	A Series: 8, 16, 24, 36way; B Series: 8, 16, 24way; C Series: 8, 16, 24way; D Series: 8, 16, 24way;
		Ausgangsspannung	110/220VAC 50/60 Hz
		Ausgangsstrom	16A, 32A 3*16A,3*32A
3	Steuer- anschlüsse	Netzanschluss	1×RJ45 Port
		Daisy-Chain-Anschluss	2×RJ45 Port
		Software-Update-Anschluss	1×RJ45 Port
		Anschluss für Temperatur und Luftfeuchtigkeit	Max 2×RJ11 Port (kann weitere hinzufügen)
		Anschluss für Rauchsensor	Max 1×RJ11 Port (optional)
		Anschluss für Wassersensor	Max 1×RJ11 Port (optional)
		Anschluss für Türsensor	Max 1×RJ11 Port (optional)
4	Anzeige	Arbeitszustand	1×LED
		Leistungsimpuls	1×LED
		IP-Adresse, M/S SMART PDU- Status, Messwert, Alarmstatus	LCD Bildschirm (Auflösung: 128×64)
5	Leistungs- anzeige	Gesamtstrom	Vollskala: 16A/32A, Genauigkeit: ±1%+0,2 Auflösung: 200mA, Ansprechzeit: 400ms

	Technologieanforderung	Individueller Laststrom	Vollskala: 10A/16A, Genauigkeit: $\pm 1\%+0,1$ , Auflösung: 100mA, Ansprechzeit: 400ms
6	Temperatur/ Feuchtigkeit Technologieanforderung	Temperatur	Genauigkeit: $\pm 1^\circ\text{C}$ , Antwort: 400ms
		Luftfeuchtigkeit	Genauigkeit: $\pm 5\%\text{RH}$ , Antwort: 400ms
7	Produktgröße	Produktgröße (L x B x H)	$X^2 \times 56 \times 52\text{mm}$
		Montageloch	$X^3$
8	Gehäusefarbe	Farbe	Black
9	Ausstattung	Montagewinkel	1 set
		Netzwerk-Anschlusskabel	2M blaues Netzwerkkabel*1
		Daisy-Chain-Verbindungskabel	2M gelbes Netzwerkkabel *1
		Serielles Verbindungskabel	2M Elfenbeinfarbenes serielles Kabel *1
		Benutzerhandbuch	1 Set (CD)
10	Optionale Ausstattung	Sensor	Temperatur-/Feuchtigkeitssensor
			Rauchsensor
			Tür-Sensor
			Sensor für Wasseransammlungen
11	Umgebung	Arbeitsumgebung	Temperatur: $0^\circ\text{C} \sim +45^\circ\text{C}$ Relative Feuchtigkeit: 30%~90%
		Lagerumgebung	Temperatur: $-20^\circ\text{C} \sim +70^\circ\text{C}$ Relative Feuchtigkeit: 0%~95%
12	ROHS	Konformität	

Dies ist ein Produkt der Klasse A. Im Wohnbereich kann dieses Produkt Funkstörungen verursachen. In diesem Fall kann vom Benutzer verlangt werden, angemessene Maßnahmen zu ergreifen.

Hiermit erklärt die Assmann Electronic GmbH, dass die gedruckte Konformitätserklärung dem Produkt beiliegt. Sollte die Konformitätserklärung fehlen, kann diese postalisch unter der unten genannten Herstelleradresse angefordert werden.

**www.assmann.com**

Assmann Electronic GmbH  
Auf dem Schüffel 3  
58513 Lüdenscheid  
Germany

