

DIGITUS®

4/8-port 10/100/1000BASE-TX+1000Base-FX Industrial Ethernet (PoE) Switch



Quick Installation Guide

DN-651148, DN-651149

DN-651150, DN-651151

DN-651152, DN-651153

Table of content

1. Overview	2
2. Features.....	3
3. Specification	3
4. Packages	7
5. Internal storage and forwarding mechanismSwitch Panel.....	8
6. Interface Definition.....	10
7. LED Indicator	13
8. Installation caution	13

1. Overview

Industrial Ethernet switch with 4/8-Port 10/100/1000Mbps RJ45 + 1000Mbps SFP, the Product meet CE, FCC, RoHS standards. Network switch has the operating temperature of -40°C ~ 80°C, has the super firmness can adapt to all kinds of harsh environment, can also be conveniently placed in the compact space of the control box. The installation characteristics of the guide rail, wide temperature operation, IP40 protection class housing and LED indicator light make the switch a plug and play industrial grade device, providing a reliable and convenient solution for users to network their Ethernet devices.

2. Features

- Support long range transmission by fiber optical port.
- Full working temp. $-40\sim 80\text{ }^{\circ}\text{C}$ to ensure reliable data and long working life
- In line with industrial operating standards, the average trouble-free work in more than 300,000 hours
- Dual power input
- Lightning Surge Protection (Power): 5000A (8/20 μs)
- DIN Rail
- Max. PoE 30W per port (DN-651149, DN-651151, DN-651153)
- Support full duplex or half duplex mode, with automatic negotiation capability
- Network port support automatic cross identification

3. Specification

3.1 Standard:

IEEE802.3i 10Base-T;

IEEE802.3u 100Base-TX;

IEEE802.3ab 1000Base-T;

IEEE802.3z 1000Base-X; IEEE802.3x;

IEEE802.3af, IEEE802.3at (PoE Version)

3.2 Interface:

10/100/1000Mbps RJ45

1000Mbps SFP

3.3 Work environment:

Working: $-40\sim 80\text{ }^{\circ}\text{C}$

Storage: $-40\sim 80\text{ }^{\circ}\text{C}$

Relative Humidity: 5%~95 % (No condensation)

3.4 Spec table:

Model No	DN-651148	DN-651149
Network port	4x1000Mbps	4x1000Mbps
SFP slot	2x 1000Mbps	2x 1000Mbps
PoE Spec.	NA	IEEE802.3af/ IEEE802.3at
Power Pin Assignment	NA	1/2+;3/6-
Bandwidth	14G	14G
Packet Buffer Memory	1.2Mbit	1.2Mbit
Forwarding rate	10.5Mbps	10.5Mbps
Mac address table	2K	2K
Max. Frame Size	9000bytes	9000bytes
Power consumption	< 5 watts	< 5 watts (Excluded PoE)
ESD protection	contact 8KV, air 12KV	
Surge protection	CM±4KV, DM±2KV	
Enclosure	IP40	
Power Supply	DC12-48V	DC48-57V
MTBF	300,000 hours	
Working Temp.	-40 to 80C	
Dimension (mm)	142.5x107.1x53	142.5x107.1x53
Weight (kg)	0.53	0.54

Model No	DN-651150	DN-651151
Network port	8x 1000Mbps	8x 1000Mbps
SFP slot	2x 1000Mbps	2x 1000Mbps
PoE Spec.	NA	IEEE802.3af/ IEEE802.3at
Power Pin Assignment	NA	1/2+;3/6-
Bandwidth	20G	20G
Packet Buffer Memory	2Mbit	2Mbit
Forwarding rate	15Mbps	15Mbps
Mac address table	4K	4K
Max. Frame Size	9000bytes	9000bytes
Power consumption	< 8 watts	< 8 watts (Excluded PoE)
ESD protection	contact 8KV, air 12KV	
Surge protection	CM±4KV, DM±2KV	
Enclosure	IP40	
Power Supply	DC12-48V	DC48-57V
MTBF	300,000 hours	
Working Temp.	-40 to 80C	
Dimension (mm)	142.5x107.1x53	142.5x107.1x53
Weight (kg)	0.6	0.62

Model No	DN-651152	DN-651153
Network port	8x 1000Mbps	8x 1000Mbps
SFP slot	4x 1000Mbps	4x 1000Mbps
PoE Spec.	NA	IEEE802.3af/ IEEE802.3at
Power Pin Assignment	NA	1/2+;3/6-
Bandwidth	52Gbps	52Gbps
Packet Buffer Memory	4.1Mbit	4.1Mbit
Forwarding rate	38.7Mbps	38.7Mbps
Mac address table	8K	8K
Max. Frame Size	9000bytes	9000bytes
Power consumption	< 10 watts	< 10 watts (Excluded PoE)
ESD protection	contact 8KV, air 12KV	
Surge protection	CM±4KV, DM±2KV	
Enclosure	IP40	
Power Supply	DC12-48V	DC48-57V
MTBF	300,000 hours	
Working Temp.	-40 to 80C	
Dimension (mm)	143.7x125x47.7	143.7x125x47.7
Weight (kg)	0.7	0.7

3.5 Power supply:

Input voltage:

DC12-48V (DN-651148, DN-651150, DN-651152)

DC48-57V (DN-651159, DN-651151, DN-651153)

Two-way power redundancy backup)

Access terminal: Rackmount kit

Support dual power redundancy

Support built-in over current 4.0A protection

Support reverse connection protection

3.6 Mechanical characteristic:

IP40 aluminum housing

DIN rail install

Natural cooling, no fan

3.7 Industrial standard:

IEC61000-4-2 (ESD): $\pm 8\text{kV}$ (contact), $\pm 12\text{kV}$ (air)

IEC61000-4-3 (RS): 10V/m ($80\sim 1000\text{MHz}$)

IEC61000-4-4 (EFT): Power Port: $\pm 2\text{kV}$; Data Port: $\pm 1\text{kV}$

IEC61000-4-5 (Surge): Power Port: $\pm 2\text{kV/CM}$, $\pm 1\text{kV/DC}$;

Data Port: $\pm 4\text{kV/CM}$, $\pm 2\text{kV/DM}$

IEC61000-4-6 (CS): 3V ($10\text{ kHz}\sim 150\text{ kHz}$); 10V ($150\text{ kHz}\sim 80\text{MHz}$)

IEC61000-4-16 (Common mode conduction): 30V (cont.), 300V (1s)

Frequency range: $150\text{kHz}\sim 80\text{MHz}$

Impact: IEC 60068-2-27

Free Fall: IEC 60068-2-32

Vibration: IEC 60068-2-6

4. Packages

- Industrial switch 1pcs
- User manual 1pcs
- Rackmount kit 1set
- Terminal block 1pcs

5. Internal storage and forwarding mechanism Switch Panel



Side panel: P1 and P2 are the number of connecting terminals, P+1 and P-1 are respectively to the positive and negative poles to be connected; Earthing screw, used for earthing equipment.



Front panel: The yellow light on the port is the LINK light, which is on when the connection is established and the data transmission is flashing.

The green light is PoE light, which is only on when the switch port is supplying power to the PD devices. Power indicator light is on when connecting with Power.

Switch size (mm)

DN-651148 / DN-651149

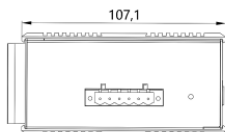
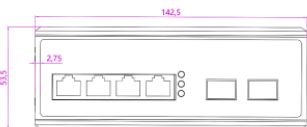
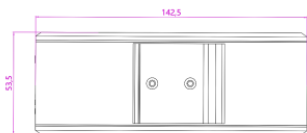
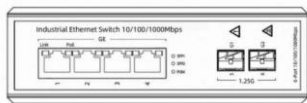

DN-651150 / DN-651151

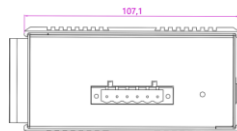
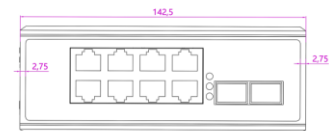
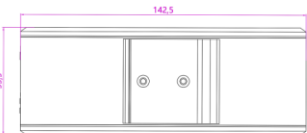
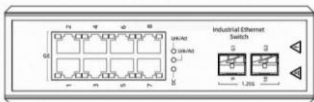

DN-651152 / DN-651153

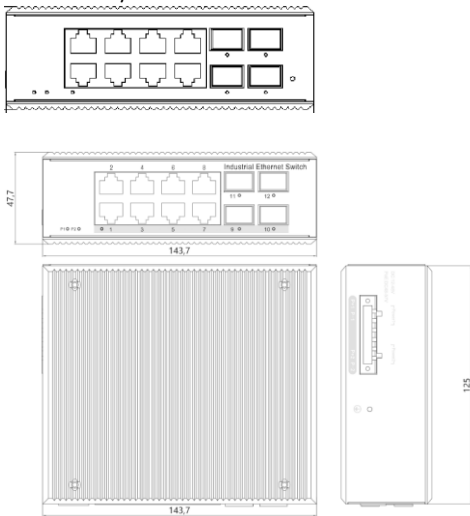

6. Interface Definition

6.1 10/100/1000Base-TX Ethernet interface:

This series of switches provides MDI/MDI-X self-identification with cable support on all 10/100/1000Base-TX ports. In use, the Ethernet port of the switch can be connected with other Ethernet terminal devices through network cables (direct or cross). Please use Class 5 shielded twisted pair. The Ethernet port pin definition is shown in the following figure:

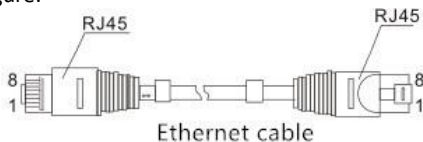

RJ45 port supports automatic MDI/MDI-X operation, you can use a straight line to connect to the PC or server, connect to other switches or hubs. In the through line (MDI), pins 1, 2, 3, 4, 5, 6, 7, 8 correspond to the connection; For the MDI-X port of a switch or hub, cross lines are used: 1-3, 2-6, 3-1, 6-2, 4-7, 5-8, 7-4, 8-5.1000Base-T (X) pins are defined as follows:

Pin No.	MDI signal	MDI-X signal
1	TX+	RX+
2	TX-	RX-
3	RX+	TX+
6	RX-	TX-
4,5,7,8	-	-

Note: “Tx ±” refers to send data ±, “Rx ±” refers to received data ±, and “-” refers to unused data.

6.2 1000base-FX Ethernet interface

This device provides 1000Base single-mode dual fiber SC module, and multi-mode like LC, ST as optional.

6.2.1 Patch cord classification

According to the transmission mode of light in the fiber, it can be divided into multi-mode fiber and single-mode fiber. Multimode fiber has a thick glass core (50 or 62.5µm), which can transmit light in various modes. However, the high inter-mode dispersion limits the frequency at which digital signals can be transmitted, so multimode fibers can be transmitted over relatively close distances (typically only a few kilometers).

The single-mode fiber has a very thin glass core (core diameter, usually 9 or 10µm) and can transmit only one mode of light. Therefore, it’s inter – module dispersion is very small, and it is suitable for remote communication. Under normal circumstances, the skin is orange for multi-mode, yellow for single mode.

6.2.2 SFP module (Optional, not included)

LC connector, Gigabit, 20km Single mode, dual fiber (DN-81011)

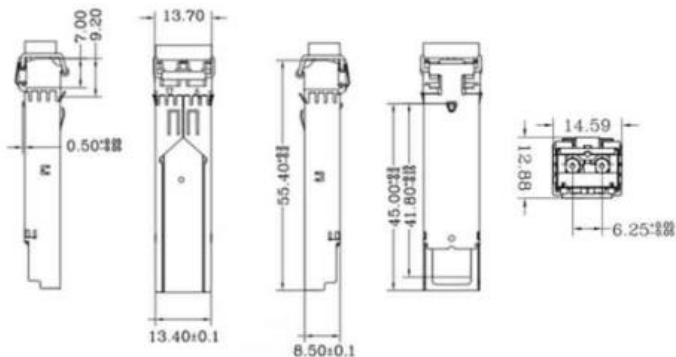

LC connector, Gigabit, 20km Single mode, Single fiber (DN-81020 and DN-81021)

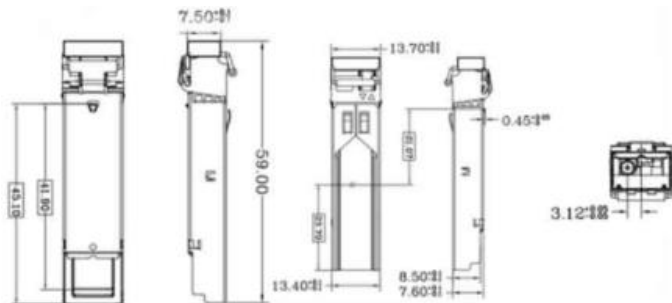

7. LED Indicator

LED indicator	Status	Definition
Power	LED on	Power supplying in normal
	LED off	Power supply abnormal or no powering
RJ45 indicator	Yellow LED on	Network connection in normal
	Yellow LED flashing	Link communication in normal
	Green LED on	PoE feeding in normal
	Yellow/Green LED off	No connection at port
LINK/ACT	Green flashing	Optical work in normal

8. Installation caution

8.1 Installation precautions

In order to avoid damage to equipment and personal injury caused by improper use, please follow the following precautions:

- In order to avoid damage caused by falling of the equipment, please put the equipment in a stable environment.
- When supplying power to the equipment, pay attention to confirm the range of power supply voltage, as well as the positive and negative poles of the power supply, so as not to damage the equipment by wrong operation.
- In order to reduce the risk of electric shock, ensure that the equipment is well grounded in the working environment.
- No matter when, please do not arbitrarily remove the equipment shell.
- When placing the switch, please avoid the area with dust and strong electromagnetic interference

8.2 Din rail installation:



The first step is to check the grounding and stability of the guide rail: the guide rail slot of the switch is clamped into the guide rail.

The second step: from the center to both sides of the guide rail positioning screws in order. Step 3: Use screws to fix the mounting rail card slot on the fixed guide groove at both ends of the guide rail to ensure that the guide rail and the switch are fixed on the guide rail vertically and stably.

8.3 grounding

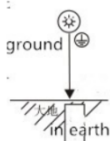

Fix the grounding wire to the grounding screw above the switch, and ensure good reliable connection of the grounding system.

8.4 Power Connection

Insert the power cord into the specified position of the 6-core terminal, and insert the terminal into the standard power supply inlet (P+1 and P-1 input corresponding to the first power supply P1, and P+2 and P-2 input corresponding to the second power supply P2). The available voltage standard of the power supply is supported from 48VDC to 57VDC

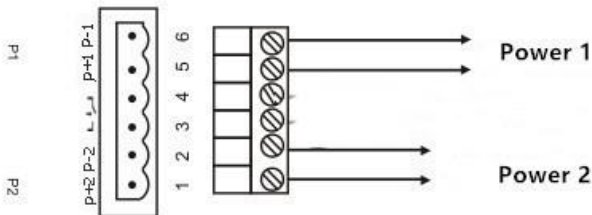

This is a Class A product. In home environment, this product may cause radio interference. In this case, the user may be required to take appropriate measures.

Hereby Assmann Electronic GmbH, declares that the Declaration of Conformity is part of the shipping content. If the Declaration of Conformity is missing, you can request it by post under the below mentioned manufacturer address.

www.assmann.com
Assmann Electronic GmbH
Auf dem Schüffel 3
58513 Lüdenscheid, Germany

