



ONLINE UPS SYSTEM

DN-170093 Rev. 2 • DN-170094 Rev. 2

DN-170095 Rev. 2 • DN-170096 Rev. 2

Manual

All rights reserved.

The information in this document is subject to change without notice.

Publish statement

Thank you for purchasing this series UPS.

This series UPS is an intelligent, single phase in single phase out, high frequency online UPS designed by our R&D team who is with years of designing experiences on UPS. With excellent electrical performance, perfect intelligent monitoring and network functions, smart appearance, complying with EMC and safety standards, The UPS meets the world's advanced level.

Read this manual carefully before installation

This manual provides technical support to the operator of the equipment.

Table of Contents

1.	Important safety warning	3
1.1.	Transportation	3
1.2.	Preparation.....	3
1.3.	Installation.....	3
1.4.	Operation	4
1.5.	Maintenance, service and faults	4
1.6.	Symbols used in this guide	5
2.	Installation and setup	5
2.1.	Unpack checking	5
2.2.	Rear panel view	5
2.3.	Installing the UPS	7
2.4.	UPS startup and turn off	15
2.5.	Configuring battery settings.....	16
2.6.	Operation and display panel	16
3.	Operations	20
3.1.	Button operation	20
3.2.	Setup the UPS.....	21
3.3.	LCD display	23
3.4.	UPS setting	24
3.5.	Operational status and mode(s).....	27
3.6.	Alarm or fault reference code	28
4.	Troubleshooting	29
5.	Storage and Maintenance	31
6.	Options	31
7.	Specification	34

1. Important safety warning

Important safety instructions – Save these instructions

Please comply with all warnings and operating instructions in this manual strictly. Save this manual properly and read carefully the following instructions before installing the unit. Do not operate this unit before reading through all safety information and operating instructions carefully.

There exists dangerous voltage and high temperature inside the UPS. During the installation, operation and maintenance, please abide the local safety instructions and relative laws, otherwise it will result in personnel injury or equipment damage. Safety instructions in this manual act as a supplementary for the local safety instructions. Our company will not assume the liability that caused by disobeying safety instructions.

1.1. Transportation

- Please transport the UPS system only in the original package to protect against shock and impact.

1.2. Preparation

- Condensation may occur if the UPS system is moved directly from cold to warm environment. The UPS system must be absolutely dry before being installed. Please allow at least two hours for the UPS system to acclimate the environment.
- Do not install the UPS system near water or in moist environments.
- Do not install the UPS system where it would be exposed to direct sunlight or near heater.
- Do not block ventilation holes in the UPS housing.

1.3. Installation

- Do not connect appliances or devices which would overload the UPS system (e.g. laser printers) to the UPS output sockets.
- Place cables in such a way that no one can step on or trip over them.
- Do not connect domestic appliances such as hair dryers to UPS output sockets.
- The UPS can be operated by any individuals with no previous experience.
- Connect the UPS system only to an earthed shockproof outlet which must be easily accessible and close to the UPS system.
- Please use only VDE-tested, CE-marked mains cable (e.g. the mains cable of your computer) to connect the UPS system to the building wiring outlet (shockproof outlet).
- Please use only VDE-tested, CE-marked power cables to connect the loads to the UPS system.
- When installing the equipment, it should ensure that the sum of the leakage current of the UPS and the connected devices does not exceed 3.5mA.

1.4. Operation

- Do not disconnect the mains cable on the UPS system or the building wiring outlet (shockproof socket outlet) during operations since this would cancel the protective earthing of the UPS system and of all connected loads.
- The UPS system features its own, internal current source (batteries). The UPS output sockets or output terminals block may be electrically live even if the UPS system is not connected to the building wiring outlet.
- In order to fully disconnect the UPS system, first press the OFF/Enter button to disconnect the mains.
- Prevent no fluids or other foreign objects from inside of the UPS system.

1.5. Maintenance, service and faults

- The UPS system operates with hazardous voltages. Repairs may be carried out only by qualified maintenance personnel.
- Caution - risk of electric shock. Even after the unit is disconnected from the mains (building wiring outlet), components inside the UPS system are still connected to the battery and electrically live and dangerous.
- Before carrying out any kind of service and/or maintenance, disconnect the batteries and verify that no current is present and no hazardous voltage exists in the terminals of high capability capacitor such as BUS-capacitors.
- Only persons are adequately familiar with batteries and with the required precautionary measures may replace batteries and supervise operations. Unauthorized persons must be kept well away from the batteries.
- Caution - risk of electric shock. The battery circuit is not isolated from the input voltage. Hazardous voltages may occur between the battery terminals and the ground. Before touching, please verify that no voltage is present!
- Batteries may cause electric shock and have a high short-circuit current. Please take the precautionary measures specified below and any other measures necessary when working with batteries:
 - remove wristwatches, rings and other metal objects
 - use only tools with insulated grips and handles.
- When changing batteries, install the same number and same type of batteries.
- Do not attempt to dispose of batteries by burning them. This could cause battery explosion.
- Do not open or destroy batteries. Escaping electrolyte can cause injury to the skin and eyes. It may be toxic.
- Please replace the fuse only with the same type and amperage in order to avoid fire hazards.
- Do not dismantle the UPS system.

1.6. Symbols used in this guide



WARNING!

Risk of electric shock



CAUTION!

Read this information to avoid equipment damage

2. Installation and setup

Note: Before installation, please inspect the unit. Be sure that nothing inside the package is damaged. Please keep the original package in a safe place for future use.

2.1. Unpack checking

1. Don't lean the UPS when moving it out from the packaging
2. Check the appearance to see if the UPS is damaged or not during the transportation, do not switch on the UPS if any damage found. Please contact the dealer right away.
3. Check the accessories according to the packing list and contact the dealer in case of missing parts.

It includes:

1x UPS user's guide

1x UPS Quickstart Guide

1x Software download license

1x USB cable

2x Power cord (input and output)

2.2. Rear panel view

1 kVA:

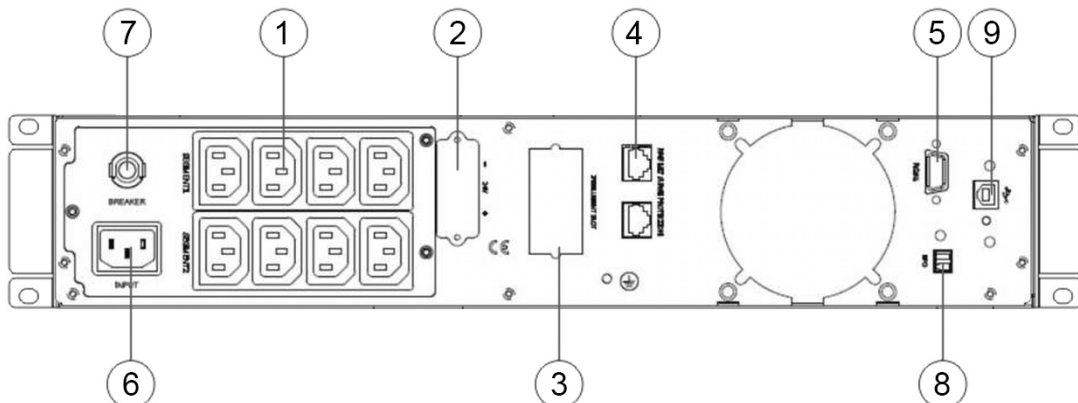

1.5 kVA:

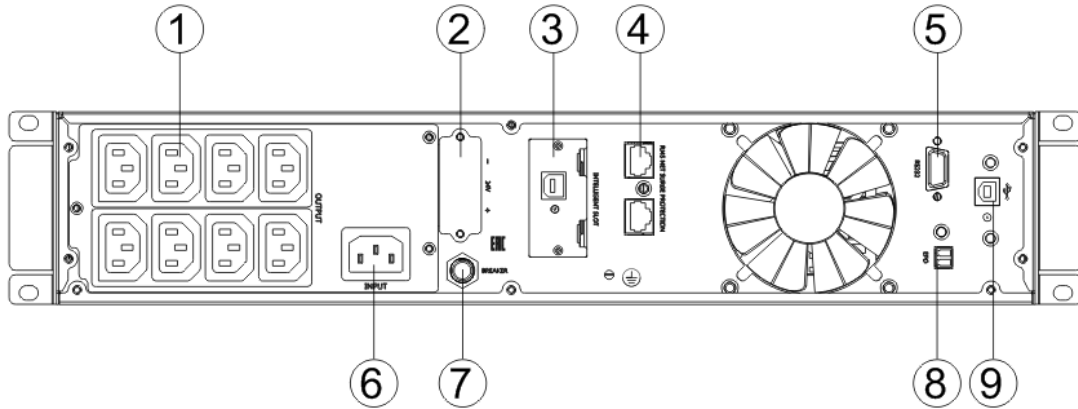

2 kVA:

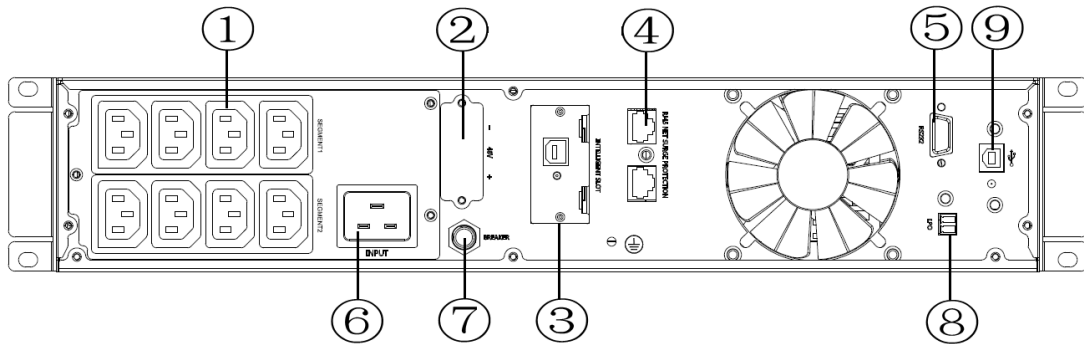

3 kVA:

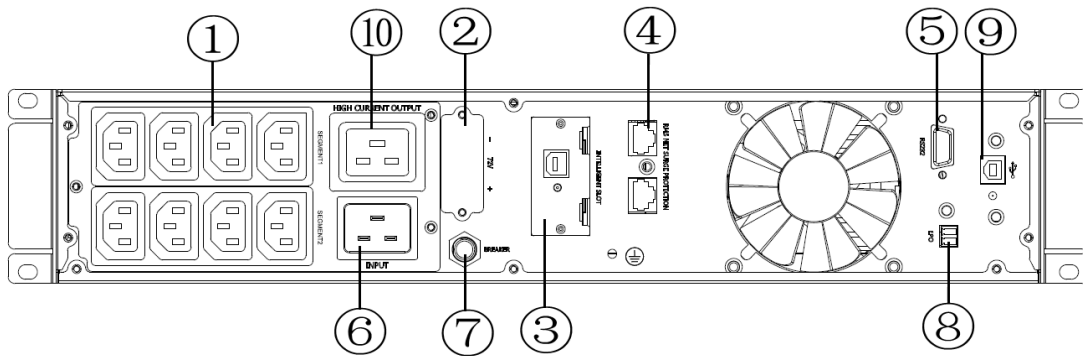

- | | |
|-------------------------------------|-------------------------------|
| (1) Output receptacles (10 A) | (6) AC input receptacle |
| (2) Battery terminal | (7) Input circuit breaker |
| (3) SNMP intelligent slot | (8) EPO (with Jumper cap) |
| (4) RJ45 data line Surge Protection | (9) USB |
| (5) RS-232 communication port | (10) Output receptacle (16 A) |

2.3. Installing the UPS

- **Rackmount installation**

The UPS is supplied with 19-inch mounting brackets for installation in the server rack. Mounting rails must be ordered separately (part number DN-170109). The rails are adaptable for installation in 19" server racks with approx. 70~76 cm (27 to 30 inch) depth.

CAUTION	
	The cabinet is heavy. Removing the cabinet from its carton requires a minimum of two people.
	If installing optional EBP(S), make sure to install the EBP(S) directly below the UPS so that all wiring between the cabinets is installed behind the front covers and inaccessible to users.
	Note: Mounting rails are required for each individual cabinet.

(1) How to install the rail kit

- a) Assemble the left and right rails to the rear rails as shown in Figure 1. Do not tighten the screws. Adjust each rail size for the depth of your rack.

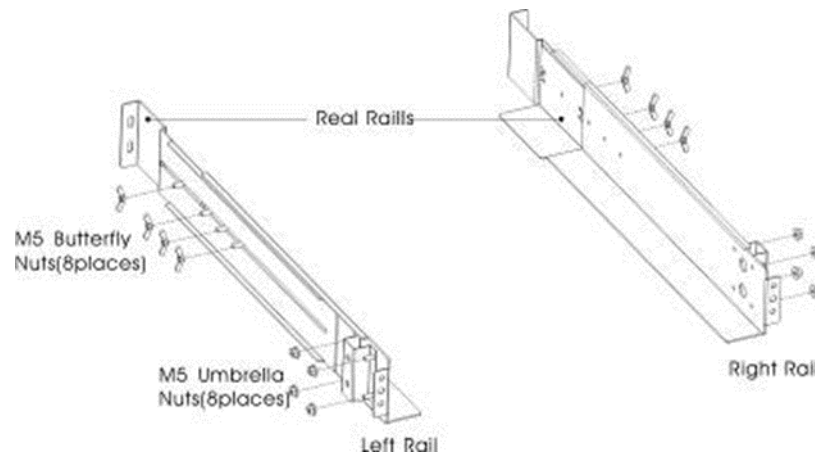

Figure 1: Securing the rails

- b) Select the proper size in the rack for positioning the UPS (see Figure 2). The rail occupies four positions on the front and rear of the rack.
- c) Tighten four M5 Umbrella Nuts in the side of rail assembly (see Figure 1).
- d) Fix one rail assembly to the front of the rack with one M5×12 pan-head screw and one M5 cage nut. Using two M5 cage nuts and two M5×12 pan-head screws, to fix the rail assembly to the rear of the rack.

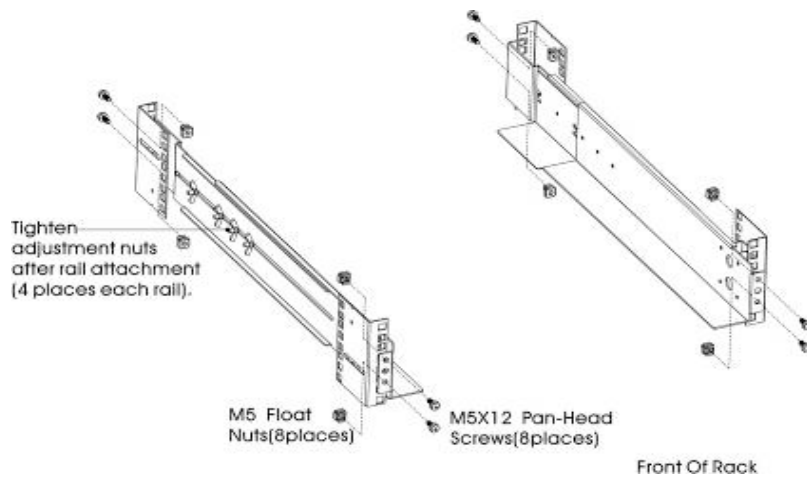

Figure 2: Fixing the rails

- e) Repeat Steps 3 and 4 for the other rail assembly.
- f) Tighten the four butterfly nuts in the middle of each rail assembly.
- g) If installing optional cabinets, repeat Step 1 through Step 6 for each rail kit.
- h) Place the UPS on a flat, stable surface with the front of the cabinet facing to you.
- i) Align the mounting brackets with the screw holes on each side of the UPS and fix with the supplied M4×8 flat-head screws (see Figure 3).

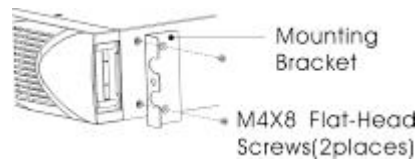

Figure 3: Installing the mounting brackets

- j) If installing optional cabinets, repeat Step 8 and 9 for each cabinet.
- k) Slide the UPS and any other optional cabinets into the rack.
- l) Secure the front of the UPS to the rack using one M5×12 pan-head screws and one M5 cage nuts on each side (see Figure 4). Install the bottom screw on each side through the bottom hole of mounting bracket and the bottom hole of the rail.

Repeat for any optional cabinets.

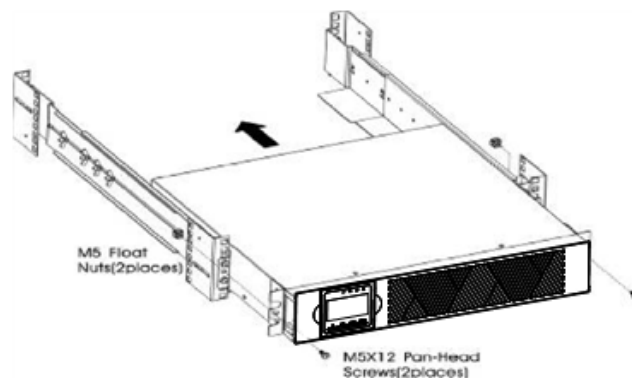

Figure 4: Securing the front of the cabinet

- m) Continue to the following section, "Rackmount Wiring Installation."

(2) Rackmount wiring installation

- a) Installing the UPS, including connecting the UPS internal batteries
 - b) Connecting any Optional EBP(S)
- See the instruction as follow chart.

• How to install the UPS

Note: Do not make unauthorized changes to the ups; otherwise, damage may occur to your equipment and void your warranty.

Note: Do not connect the ups power cord to utility until after installation is completed.

- a) Remove the front cover of each UPS

Press the cover side with LCD display, hold the other side and quickly extract it, then extract the other side with display. (see Figure 5)

Note: A ribbon cable connects the LCD control cover to the UPS. Do not pull on the cable or disconnect it.

When remove the cover, Operate as the following right Figure shows instead of the left one. (see Figure 5)

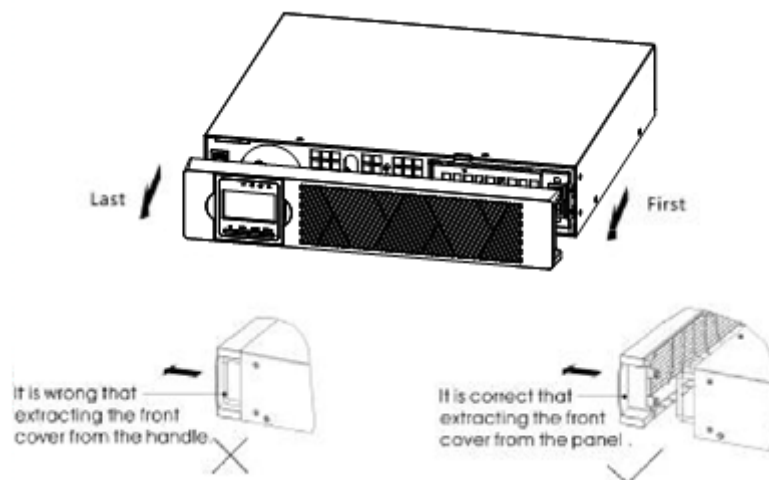

Figure 5: Extract the UPS front cover

CAUTION



A small amount of arcing may occur when connecting the internal batteries. This is normal and will not harm personnel. Connect the cables quickly and firmly.

- b) Connect the internal battery connector (see Figure 6). Connect red to red, Press the connector tightly together to ensure a proper connection.
- c) If you are installing EBPS, see the following section, “Connecting the EBP(s),” before continuing with the UPS installation.

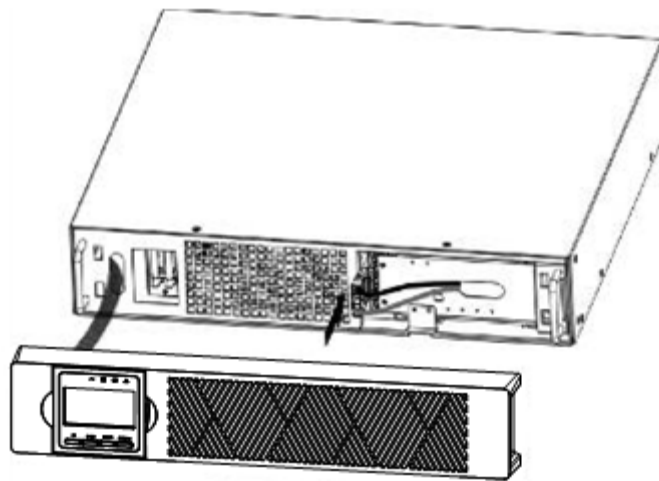

Figure 6: Connecting the UPS internal batteries

d) Replace the UPS front cover

To replace the cover, verify that the ribbon cable is protected and (if EBPS are installed) the EBP cable is routed through the knock out on the bottom of the cover.

Put the front cover hooks of side with display to the cover port, put another side to the other two ports, then press it until the cover and the chassis are combined tightly.

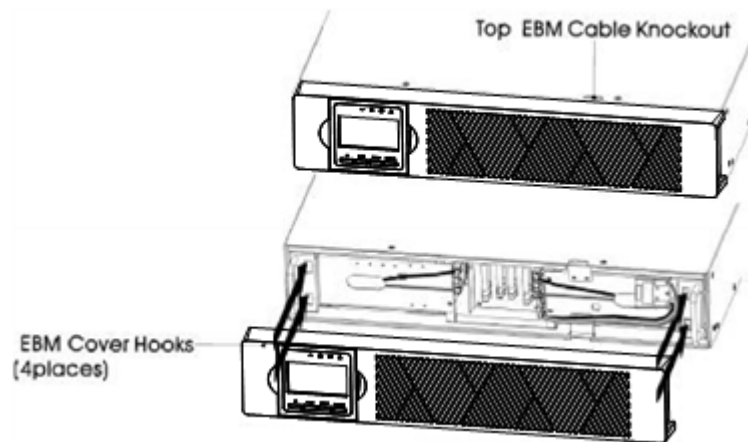

Figure 7

e) If you are installing power management software, connect your computer to one of the communication ports or optional connectivity card. For the communication ports, use an appropriate cable.

Note: Using the provide USB cable is required. (RS232 cable is optional.)

f) If your rack has conductors for grounding or bonding of ungrounded metal parts, connect the ground cable (not supplied) to the ground bonding screw. See “Rear Covers” for the location of the ground bonding screw for each model.

- g) If an emergency power-off (disconnect) switch is required by local codes, see “Emergency Power-off” (EPO) to install the remote EPO switch before powering on the UPS.

Note: Do not remove the jumper cap, if EPO is not used.

- h) Continue to “UPS Startup”.

- **Connecting the EBP(s)**

- (1) To install the optional EBP(s) for a UPS**

- a) Remove the front cover of each EBP and UPS (see Figure 8).

It is the same with the installation of the front cover. (Refer “To install the UPS”)

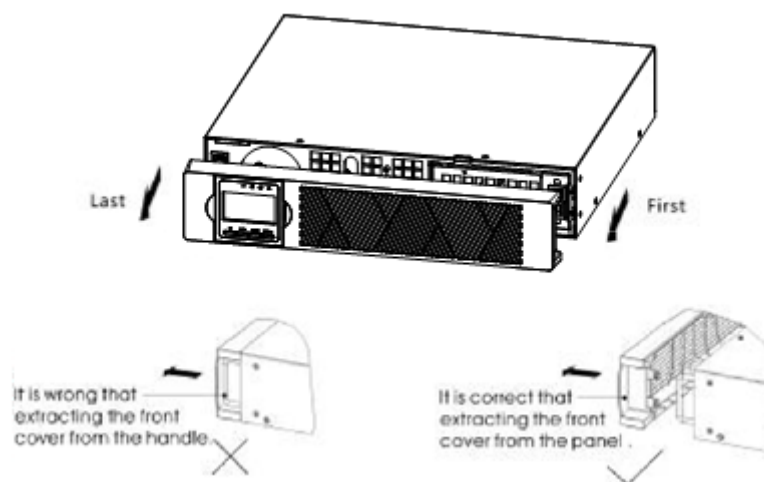

Figure 8: Removing the EBP Front Cover

- b) On the bottom of the UPS front cover, remove the EBP cable knockout (see Figure 9).

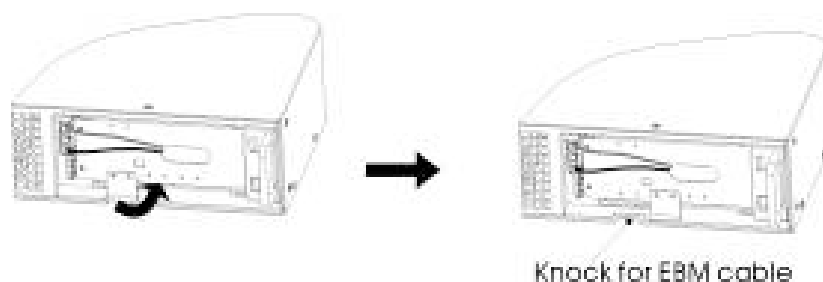

Figure 9: Removing the UPS Cable Knockout

- c) For the bottom (or only) EBP, remove the EBP cable knockout on the top of the EBP front cover. See Figure 10 for the location of the top EBP cable knockout.
- d) If you are installing more than one EBP, for each additional EBP remove the EBP cable knockout on the top and bottom of the EBP front cover. See Figure 10 for the location of the EBP cable knockouts.

CAUTION



A small amount of arcing may occur when connecting an EBP to the UPS. This is normal and will not harm personnel. Insert the EBP cable into the UPS battery connector quickly and firmly.

- e) Plug the EBP cable(s) into the battery connector(s) as shown in Figure 10. Up to four EBPS may be connected to the UPS. Connect black to black. Press the connector tightly together to ensure a proper connection.

To connect a second EBP, unclip the EBP connector on the first EBP and pull gently to extend the wiring to the EBP connector on the second EBP. Repeat for any additional EBPs.

- f) Verify that the EBP connections are tight and the adequate bend radius and strain relief exist for each cable.

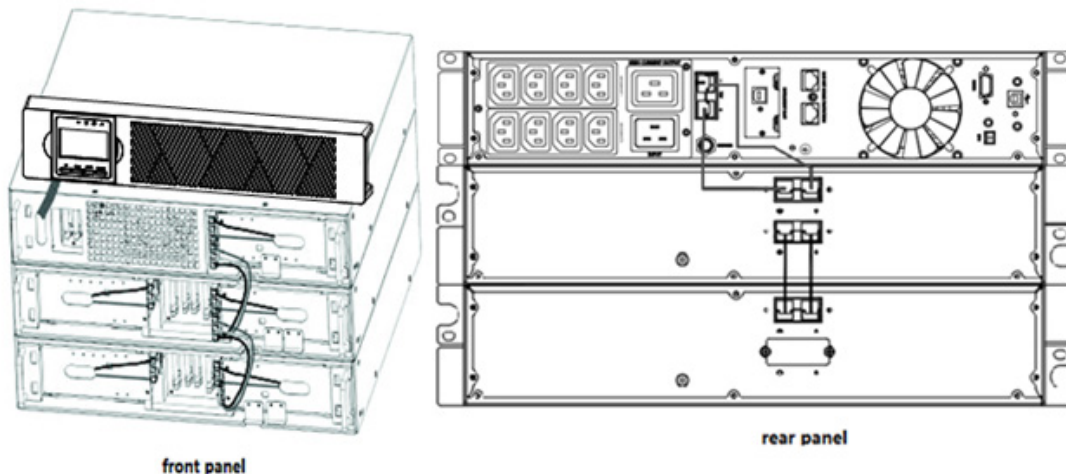

Figure 10: Typical EBP installation

- g) Replace the EBP front cover.

To replace the cover, verify that the EBP cables are routed through the EBP cover knockouts, cover connects with the cover hook near the left side of the EBP cabinet. Repeat for each additional EBP.

It is the same with the installation of the front cover. (Refer "how to install the UPS")

- h) Verify that all wires connected between the UPS and EBP(s) are installed behind the front covers and not accessible to users.
- i) Return to Step 4 to continue the UPS installation.

- **Rackmount converted to tower installation**

- (1) Rackmount converted to tower plastic base installation**

- ① Two plastic base brackets
 - ② Flatten it after intercrossing

Intercross as following figure:

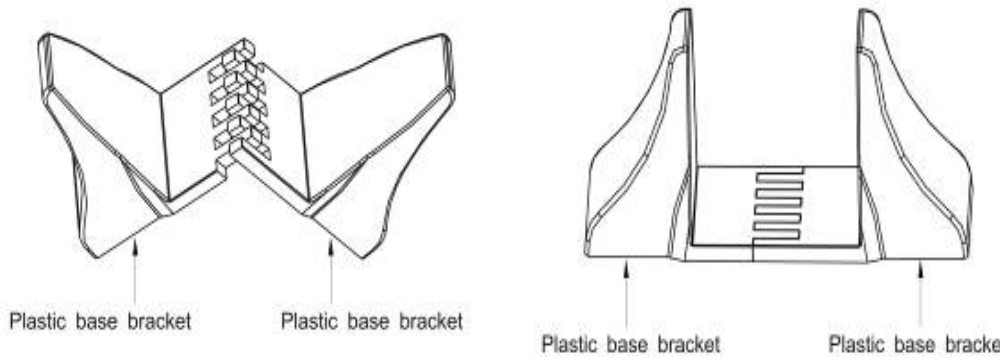

Figure 11 plastic base installation

- ③ If an EBP is needed to be placed in the middle, the assembly of plastic base is similar (Figure 11). The difference is that two 1U plastic base extended boards are added in the middle. (as the following shows)

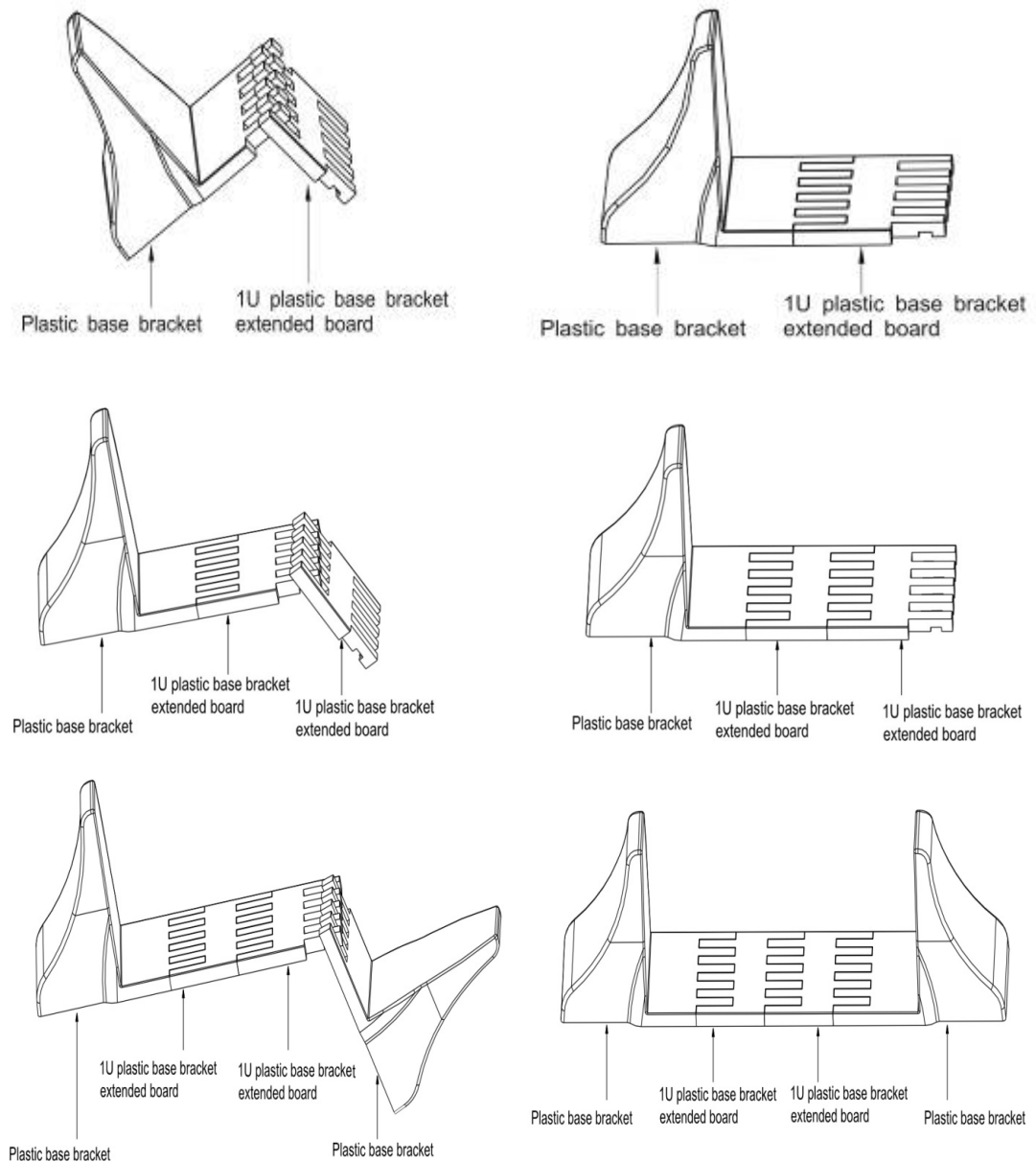

Figure 12: Increase EBP plasticbase installation

(2) Rackmount converted to Tower LCD Display plasticbase installation

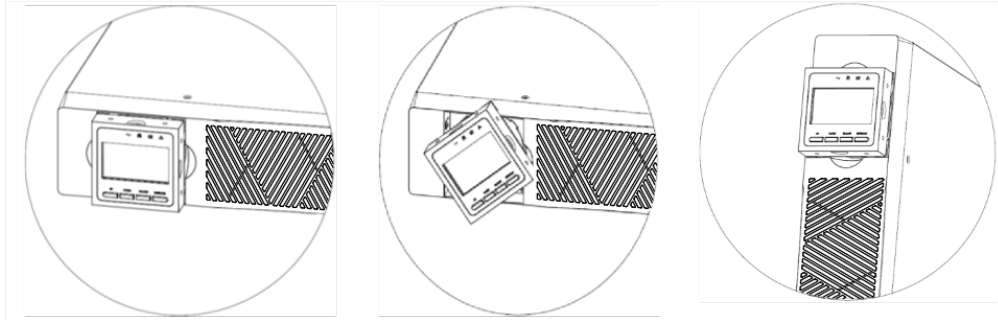

Figure 13: increase UPS plastic base installation

- The installation between UPS and EBPS can be referred to Figure 14

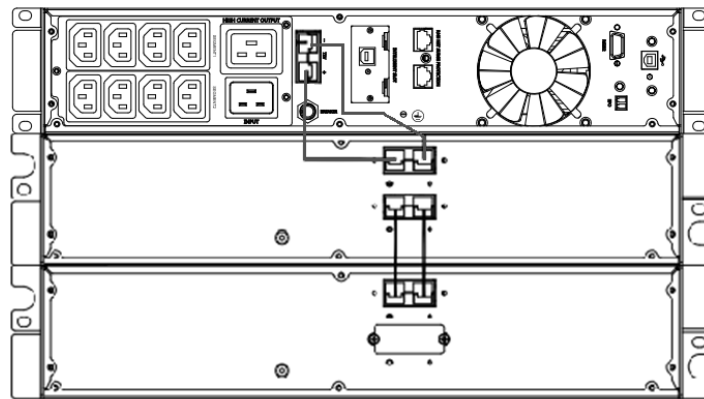
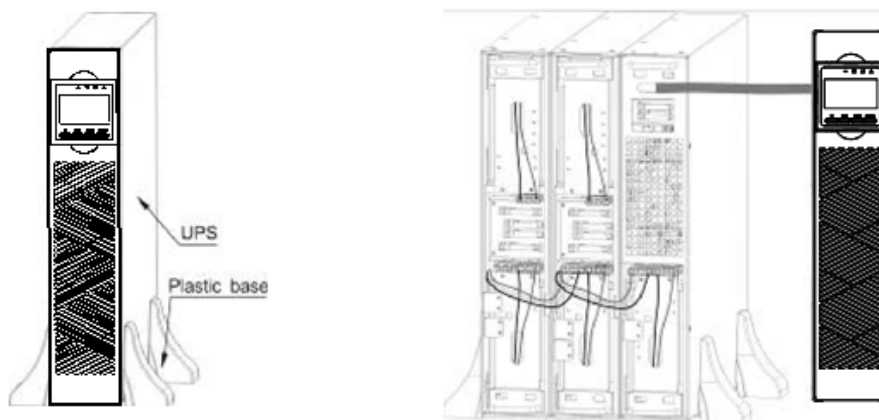

Figure 14: The installation for UPS and battery boxes

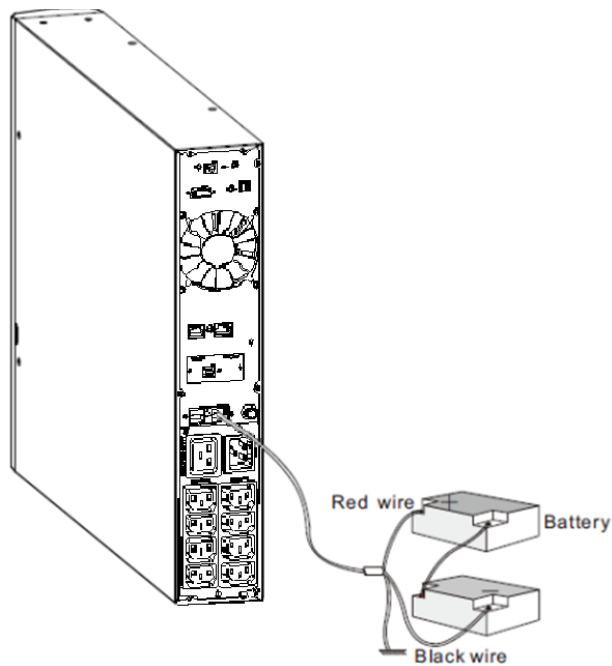

Figure 15: Long backup external battery connection

- a) Install the base, then place the RT UPS on the base one by one as Figure 14 shows.
- b) The cover installation and cable connection of the UPS and EBPS are the same as RT. (To install the optional EBP(s) for a UPS)

2.4. UPS startup and turn off

- **Startup operation**

- (1) Turn on the UPS in line mode

Note: Verify that the total equipment ratings do not exceed the UPS capacity to prevent an overload alarm.

- a) Once mains power is plugged in, the UPS will charge the battery, at the moment, the LCD shows that the output voltage is 220, which means the UPS automatically start the inverter. If it is expected to change to bypass mode, you can Press "OFF" key.
 - b) Press and hold the ON key for more than three seconds to start the UPS, then it will start the inverter.
 - c) Once started, the UPS will perform a self-test function, LED will light and go out circularly and orderly. When the self-test finishes, it will come to line mode, the corresponding LED lights, the UPS is working in line mode.
- (2) Turn on the UPS by DC without mains power
 - a) When mains power is disconnected, press and hold the ON key for more than half a second to start UPS.
 - b) The operation of the UPS in the process of start is almost the same as that when mains power is in. After finishing the self-test, the corresponding LED lights and the UPS is working in battery mode.

- **Turn off operation**

(1) Turn off the UPS in line mode

- a) Press and hold the OFF key for more than half a second to turn off the UPS and inverter.
- b) After the UPS shutdown, the LEDs go out and there is no output. If output is needed, you can set bps "ON" on the LCD setting menu.

(2) Turn off the UPS by DC without mains power

- a) Press and hold the OFF key for more than half a second to turn off the UPS.
- b) When turning off the UPS, it will do self-testing firstly. The LEDs light and go out circularly and orderly until there is no display on the cover.

2.5. Configuring battery settings

- **Set the UPS for the number of EBPs installed**

To ensure maximum battery runtime, configure the UPS for the correct number of EBPs, refer to below table for the appropriate setting of battery numbers and type. Use the up and down scroll keys to select the number of battery strings according to your UPS configuration:

All UPS and EBP cabinets	Number of battery strings
UPS only (internal batteries)	1 (default)
UPS + 1 EBP	3
UPS + 2 EBPs	5
UPS + 3 EBPs	7
UPS + 4 EBPs	9
Note: The UPS contains one battery string; each EBP contains two battery strings.	



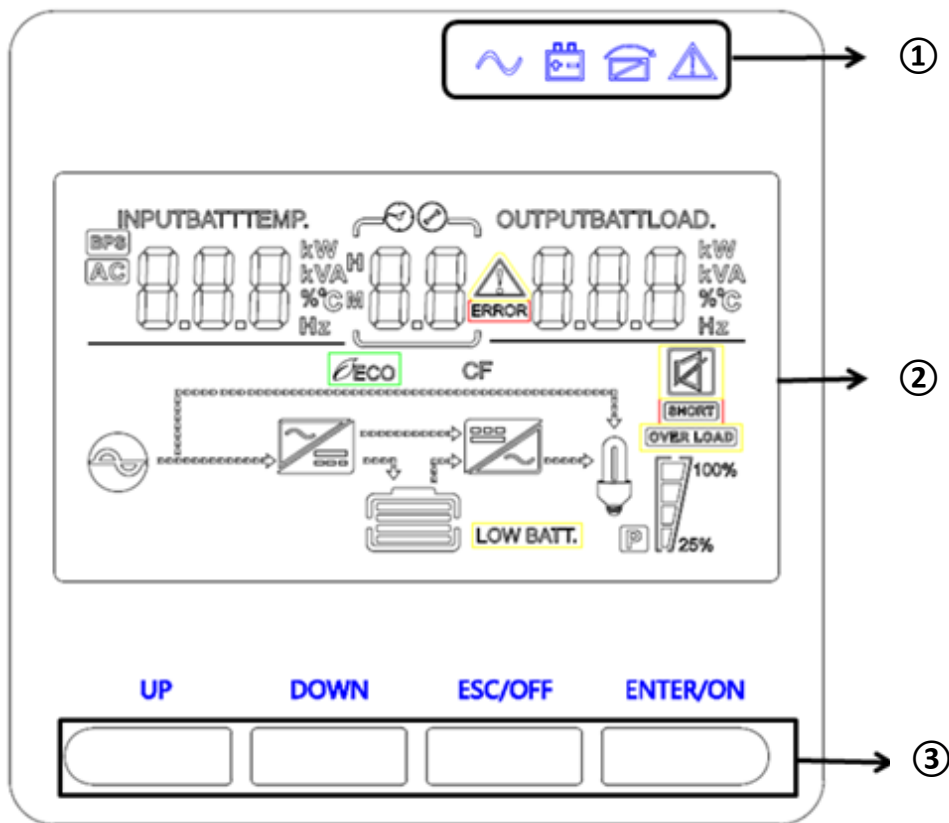

2.6. Operation and display panel

The operation and display panel, shown in below chart, is on the front panel of the inverter. It includes three indicators, four function keys and a LCD display, indicating the operating status and input/output power information.



- ① LED (from right to left: “alarm”, “bypass”, “battery”, “inverter”)
- ② On-Line UPS LCD display
- ③ Function keys

LED indicator

Indicator	Description
 Red	ON: The UPS has an active alarm or fault
 Yellow	The UPS is in Bypass mode. ON: The UPS is operating normally on bypass during High Efficiency operation.
 Yellow	ON: The UPS is in Battery mode.
 Green	ON: The UPS is operating normally.







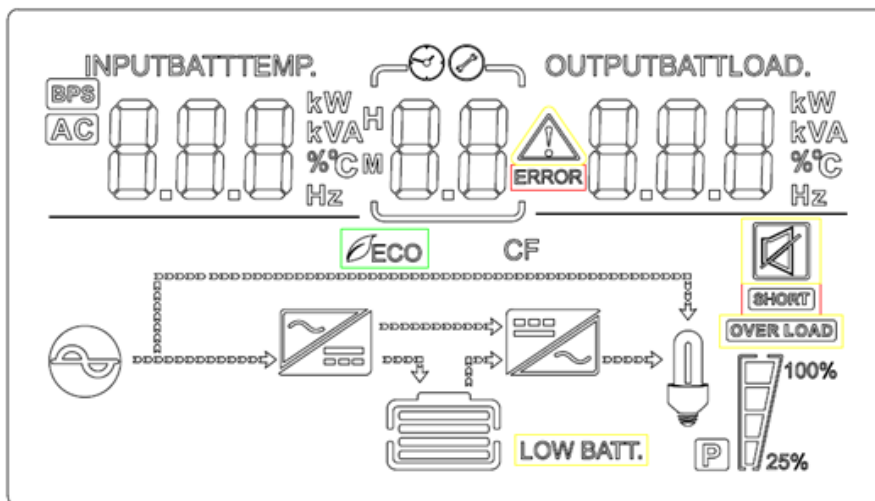

Note: When power on or startup, these indicators will turn on and off sequentially.
Note: On different operation modes, these indicators will indicate differently.









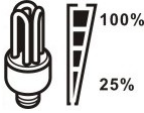

Function Keys

Function key	Description
ESC/OFF	To exit setting mode or turn off the UPS
UP	To go to previous selection or turn on the UPS
DOWN	To go to next selection
ENTER/ON	To confirm the selection in setting mode or enter setting mode

LCD Display Icons



Icon	Function/Description												
Input source information													
	Indicates the AC input												
	Indicates input voltage, input frequency, PV voltage, battery voltage and temperature												
Configuration program and fault information													
	Indicates the settings programs												
	Indicates the warning and fault codes Warning:  flashing with warning code Fault:  flashing with fault code												
Output information													
	Indicate output voltage, output frequency, load percent, load in VA, load in Watt and discharging current.												
Battery information													
	Indicates battery level by 0-24%, 25-49%, 50-74% and 75-100% in battery mode and charging status in line mode.												
In AC mode, it will present battery charging status.													
<table border="1"> <thead> <tr> <th>Status</th> <th>Battery capacity</th> <th>LCD displays</th> </tr> </thead> <tbody> <tr> <td rowspan="4">Constant Current mode</td> <td>0 – 24 %</td> <td>4 bars will flash in turns</td> </tr> <tr> <td>25 – 49 %</td> <td>Bottom bar will be on and the other three bars will flash in turns</td> </tr> <tr> <td>50 – 74 %</td> <td>Bottom two bars will be on and the other two bars will flash in turns</td> </tr> <tr> <td>75 – 100 %</td> <td>Bottom three bars will be on and the top bar will flash</td> </tr> </tbody> </table>		Status	Battery capacity	LCD displays	Constant Current mode	0 – 24 %	4 bars will flash in turns	25 – 49 %	Bottom bar will be on and the other three bars will flash in turns	50 – 74 %	Bottom two bars will be on and the other two bars will flash in turns	75 – 100 %	Bottom three bars will be on and the top bar will flash
Status	Battery capacity	LCD displays											
Constant Current mode	0 – 24 %	4 bars will flash in turns											
	25 – 49 %	Bottom bar will be on and the other three bars will flash in turns											
	50 – 74 %	Bottom two bars will be on and the other two bars will flash in turns											
	75 – 100 %	Bottom three bars will be on and the top bar will flash											

Load information				
	Indicates overload			
	Indicates the load level by 0 – 24%, 25 – 49%, 50 – 74%, 75 – 100%			
	0 – 24 %	25 – 49 %	50 – 74 %	75 – 100 %
				
Mode operation information				
	Indicates unit connects to the mains			
	Indicates load is supplied by utility power			
	Indicates the utility charger circuit is working			
	Indicates the DC/AC inverter circuit is working			
Mute operation				
	Indicates unit alarm is disabled			

3. Operations

3.1. Button operation

Button	Function
ON/ENTER	<ul style="list-style-type: none"> • Turn on the UPS: Press and hold ON button for at least 2 seconds to turn on the UPS. • Confirm current settings: When the UPS enters the setting mode, must press this button to confirm the settings value what you want, next press up/down button to change settings information • Out off bypass mode: when the UPS enter to bypass mode, press and hold this button it will switch to normal mode.
OFF/ESC	<ul style="list-style-type: none"> • Turn off the UPS: Press and hold this button at least 2 seconds to turn off the UPS in battery mode. UPS will be in standby mode under power normal or transfer to Bypass mode if the Bypass enable setting by pressing this button. • Exit setting mode: Press this button to exit setting mode when in UPS setting mode, but save nothing.
UP	<ul style="list-style-type: none"> • Up key: Press this button to display previous selection in UPS setting mode.

DOWN	<ul style="list-style-type: none"> Down key: Press this button to display next selection in UPS setting mode. To confirm selection and exit setting mode: Press this button to confirm selection and exit setting mode when LCD display the last selection in UPS setting mode.
UP + DOWN	<ul style="list-style-type: none"> Setting mode: Press and hold this button for 5 seconds to enter UPS setting mode.

3.2. Setup the UPS

Step 1: UPS input connection

Plug the UPS into a two-pole, three-wire, grounded receptacle only. Avoid using extension cords.

- For 208/220/230/240VAC models: The power cord is supplied in the UPS package

Step 2: UPS output connection

- For socket-type outputs, simply connect devices to the outlets.
- For terminal-type input or outputs, please follow below steps for the wiring configuration:
 - Remove the small cover of the terminal block
 - Suggest using AWG14 or 2.1mm² power cords for 3KVA (208/220/230/240VAC models).
 - Upon completion of the wiring configuration, please check whether the wires are securely affixed.
 - Put the small cover back to the rear panel.

Step 3: Communication connection

Communication port

USB port



RS-232 port

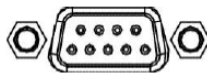

Intelligent slot

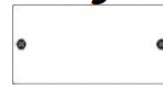

To allow for unattended UPS shutdown/start-up and status monitoring, connect the communication cable one end to the USB/RS-232 port and the other to the communication port of your PC. With the monitoring software installed, you can schedule UPS shutdown/start-up and monitor UPS status through PC.

The UPS is equipped with intelligent slot perfect for either SNMP or Relay card. When installing either SNMP or Relay card in the UPS, it will provide advanced communication and monitoring options.

Note: USB port and RS-232 port can't work at the same time.

Note: Using the provide USB cable is required. (RS232 cable is optional.)

Step 4: Turn on the UPS

Press the ON button on the front panel for two seconds to power on the UPS.

Note: The battery charges fully during the first five hours of normal operation.
Do not expect full battery run capability during this initial charge period.

Step 5: Install software

For optimal computer system protection, install UPS monitoring software to fully configure UPS shutdown. You may insert provided CD into CD-ROM to install the monitoring software. You may follow the Software License Card instruction to install the monitoring software.

Note: The software product SN. can be only allowed for one PC installation.

1 Download UPSilon 2000 installation files.

<http://www.megatec.com.tw/UPSilon2000V5.4.Download.zip>



2 Execute UPSilon 2000 V5.4\Windows \setup.exe to start installation.

3 In installation process, enter product SN. at the bottom, and continue to complete installation.

4 Check if Rupsmon is running in the taskbar, and check if Rupsmon service has been activated.

Product SN.

3.3. LCD display

Part one: Rack display

There are 8 interfaces available in the LCD display.

Item	Interface description	Content displayed
01	Input voltage & output voltage	
02	Input frequency & output frequency	
03	Input frequency & output frequency Battery voltage & backuo time & battery capacity	
04	Load	

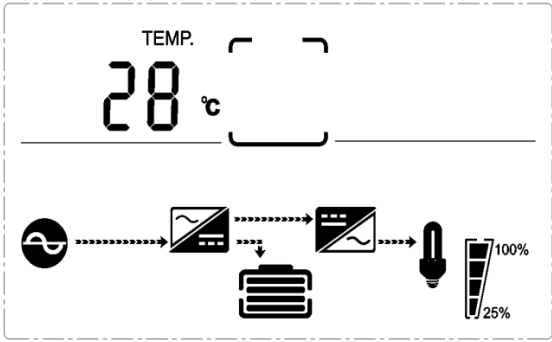
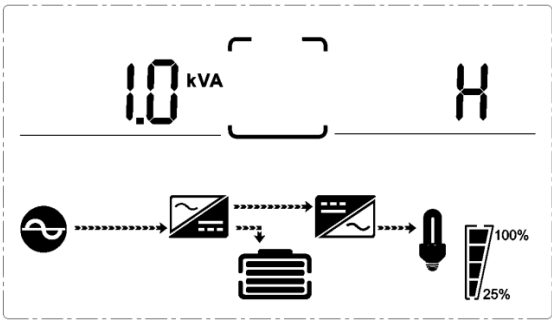
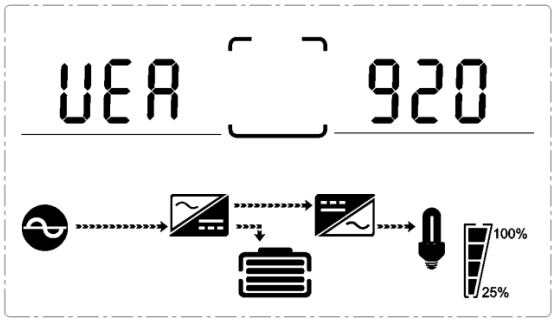
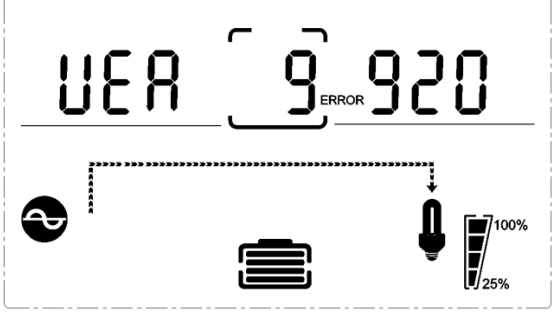
05	Environment Temperature	
06	UPS model	
07	Firmware version	
08	Alarm code (warning message) All alarm codes are present when abnormal behavior(s) occur(s)	

3.4. UPS setting

The UPS has setting functions. This user settings can be done under any kind of UPS working mode. The setting will take effect under certain condition. Below table describes how to set the UPS.



The setting function is controlled by 4 buttons (Up, Down, ON/Enter, OFF/ESC):





- Up ▲ + Down ▼ --- goes into the setting page;
- ON/Enter --- confirm the settings option;
- Up ▲ + Down ▼ --- value adjustment for choosing different pages;
- OFF/ESC --- Exit setting mode;

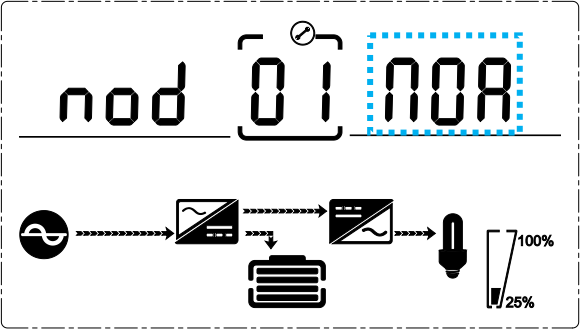
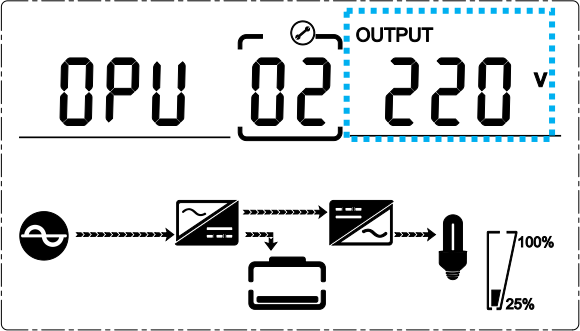
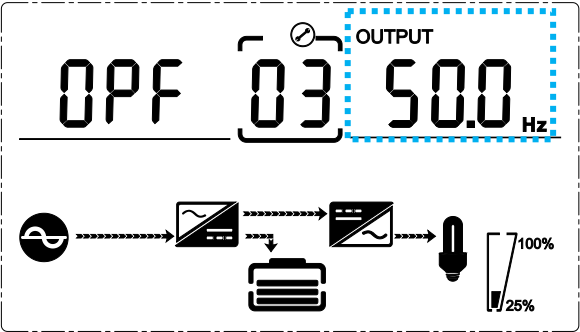

After the UPS turn ON, press buttons “UP+Down” for 5 seconds and then goes into

the setting interface page.

Note: Press “Down” button to confirm selection and exit setting mode when LCD display the last selection in UPS setting mode.

Item	Settings	Content displayed
01	<p>Mode setting</p> <ul style="list-style-type: none"> • Press Enter button to change the setting (ECO or NOR or CF or GEN). • Press UP ▲ button to select the previous setting. • Press DOWN ▼ button to select the next setting. 	
02	<p>Output voltage setting</p> <ul style="list-style-type: none"> • Press Enter button to change the setting (208, 220, 230, 240). • Press UP ▲ button to select the previous setting. • Press DOWN ▼ button to select the next setting. 	
03	<p>Frequency setting</p> <ul style="list-style-type: none"> • Press Enter button to change the setting (50 or 60Hz). • Press UP button ▲ to select the previous setting. • Press DOWN button ▼ to select the next setting. 	
04	<p>Battery capacity setting</p> <ul style="list-style-type: none"> • Press Enter button to change the setting (Battery capacity range is 1-200Ah). • Press UP button ▲ to select the previous setting. • Press DOWN button ▼ to select the next setting. 	

05	<p>Battery EOD voltage setting (Once)</p> <ul style="list-style-type: none"> • Press Enter button to change the setting (1.75/1.84/1.92). • Press UP button ▲ to select the previous setting. • Press DOWN button ▼ to select the next setting. 	 <p>The LCD display shows 'Eod' followed by '05' in a bracketed box and '1.75 V' in a dashed blue box. Below the display is a diagram of a battery pack connected to a power source, with a battery level indicator showing 100% and 25% levels.</p>
06	<p>Battery EOD voltage setting (Second)</p> <ul style="list-style-type: none"> • Press Enter button to change the setting (1.60/1.70/1.75/1.80). • Press UP button ▲ to select the previous setting. • Press DOWN button ▼ to select the next setting. 	 <p>The LCD display shows 'Eod' followed by '06' in a bracketed box and '1.75 V' in a dashed blue box. Below the display is a diagram of a battery pack connected to a power source, with a battery level indicator showing 100% and 25% levels.</p>
07	<p>Bypass voltage upper limit setting</p> <ul style="list-style-type: none"> • Press Enter button to change the setting (The bypass voltage upper limit range is 230 – 264Vac). • Press UP button ▲ to select the previous setting. • Press DOWN button ▼ to select the next setting. 	 <p>The LCD display shows 'BPS' followed by 'HLS' and '07' in a bracketed box, and '264 V' in a dashed blue box. Below the display is a diagram of a battery pack connected to a power source, with a battery level indicator showing 100% and 25% levels.</p>
08	<p>Bypass voltage lower limit setting</p> <ul style="list-style-type: none"> • Press Enter button to change the setting (The bypass voltage lower limit range is 170 - 220Vac). • Press UP button ▲ to select the previous setting. • Press DOWN button ▼ to select the next setting. 	 <p>The LCD display shows 'BPS' followed by 'LLS' and '08' in a bracketed box, and '170 V' in a dashed blue box. Below the display is a diagram of a battery pack connected to a power source, with a battery level indicator showing 100% and 25% levels.</p>

09	<p>Mute setting</p> <ul style="list-style-type: none"> • Press Enter button to change the setting (ON or OFF). • Press UP button ▲ to select the previous setting. • Press DOWN button ▼ to save and exit the setup. 	
10	<p>BYPASS enable/disable setting</p> <ul style="list-style-type: none"> • Press Enter button to change the setting (ON or OFF). • Press UP button ▲ to select the previous setting. • Press DOWN button ▼ to save and exit the setup. 	

3.5. Operational status and mode(s)

Item	Content Displayed
2	Standby Mode
3	No Output
4	Bypass Mode
5	Utility Mode
6	Battery Mode
7	Battery Self-diagnostics
8	Inverter is starting up
9	ECO Mode
10	EPO Mode
11	Maintenance Bypass Mode
12	Fault Mode
13	Generator Mode

3.6. Alarm or fault reference code

Event log	UPS Alarm Warning	Buzzer	LED
1	Rectifier Fault	Beep continuously	Fault LED lit
2	Inverter fault (Including Inverter bridge is shorted)	Beep continuously	Fault LED lit
9	Fan fault	Beep continuously	Fault LED lit
12	Selftest fault	Beep continuously	Fault LED lit
13	Battery Charger fault	Beep continuously	Fault LED lit
15	DC Bus over voltage	Beep continuously	Fault LED lit
16	DC Bus below voltage	Beep continuously	Fault LED lit
17	DC bus unbalance	Beep continuously	Fault LED lit
18	Soft start failed	Beep continuously	Fault LED lit
19	Rectification model Over Temperature	Twice per second	Fault LED lit
20	Inverter model Over Temperature	Twice per second	Fault LED lit
26	Battery over voltage	Once per second	Fault LED blinking
29	Output Short-circuit	Once per second	Fault LED blinking
30	Input current limit	Once per second	Fault LED blinking
31	Bypass over current	Once per second	BPS LED blinking
32	Overload	Once per second	INV or BPS LED blinking
33	No battery	Once per second	Battery LED blinking
34	Battery under voltage	Once per second	Battery LED blinking
35	Battery low pre-warning	Once per second	Battery LED blinking
36	Over load time out	Once per 2 seconds	Fault LED blinking
37	DC component over limit.	Once per 2 seconds	INV LED blinking
39	Mains volt. Abnormal	Once per 2 seconds	Battery LED lit
40	Mains freq. abnormal	Once per 2 seconds	Battery LED lit
41	Bypass Not Available		BPS LED blinking
42	Bypass out of tracking range		BPS LED blinking
45	EPO Enable	Beep continuously	Fault LED lit

4. Troubleshooting

If the UPS system does not operate correctly, please solve the problem by using the table below and the Trouble Shooting Chart.

Symptom	Possible cause	Remedy
No indication and alarm even though the mains is normal.	The AC input power is not connected well.	Check if input power cord firmly connected to the mains.
	The AC input is connected to the UPS output.	Plug AC input power cord to AC input correctly.
Alarm code is shown as "33" and battery led blinking.	The external or internal battery is incorrectly connected.	Check if all batteries are connected well.
Alarm code is shown as "26" and battery led blinking.	Battery voltage is too high or the charger is fault.	Contact your dealer.
Alarm code is shown as "34" and battery led blinking	Battery voltage is too low or the charger is fault.	Contact your dealer.
Alarm code is shown as "32" and INV or BYPASS led blinking.	UPS is overload	Remove excess loads from UPS output.
Alarm code is shown as "29" and FAULT led light.	The UPS shut down automatically because short circuit occurs on the UPS output.	Check output wiring and if connected devices are in short circuit status.
Alarm code is shown as "9" and FAULT led light.	Fan fault.	Contact your dealer.
Alarm code is shown as "01,02,15,16,17,18"	A UPS internal fault has occurred.	Contact your dealer.
Battery backup time is shorter than nominal value	Batteries are not fully charged	Charge the batteries for at least 5 hours and then check capacity. If the problem still persists, consult your dealer.
	Batteries defect	Contact your dealer to replace the battery.

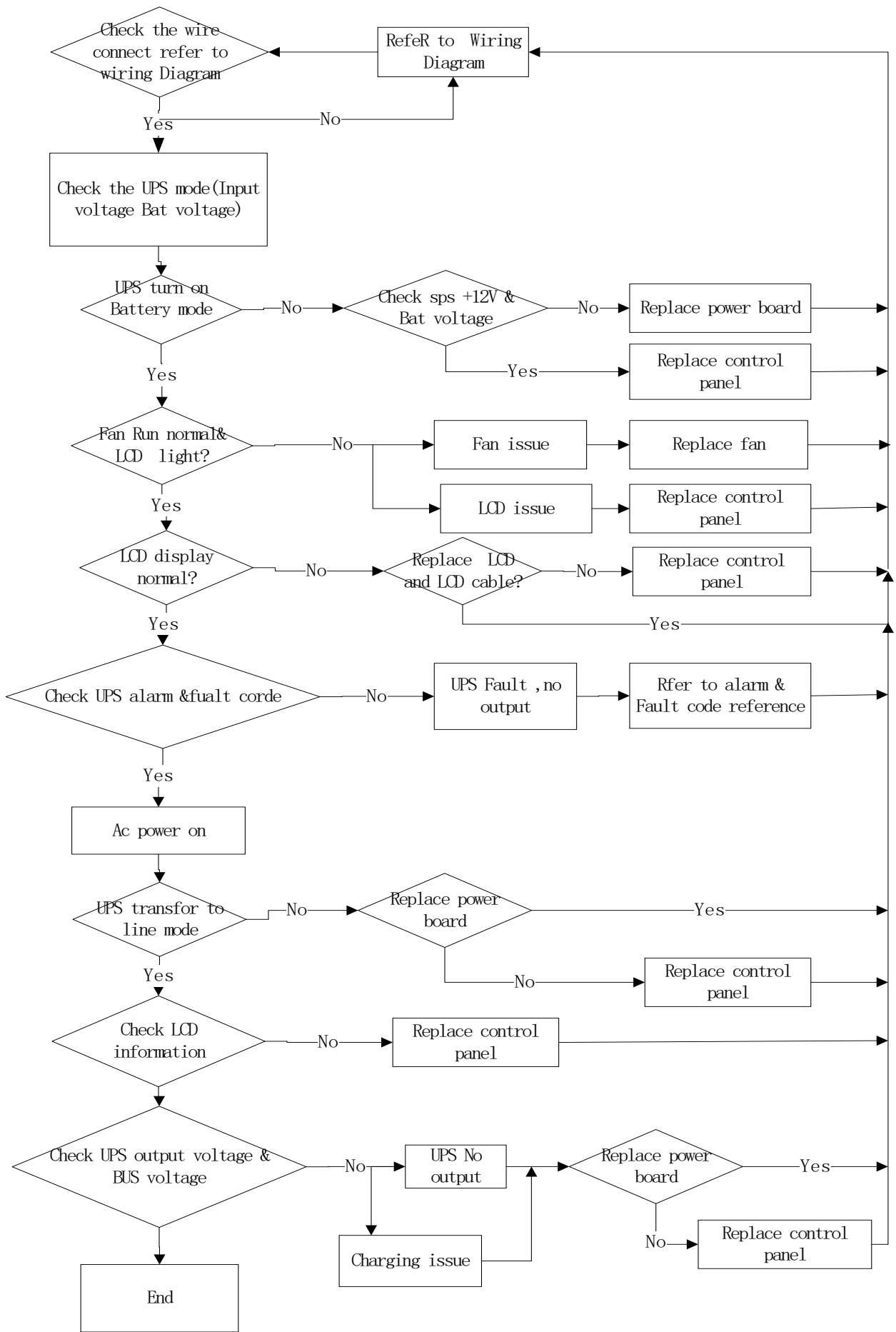

Troubleshooting Chart

5. Storage and Maintenance

- **Operation**

The UPS system contains no user-serviceable parts. If the battery service life (3~5 years at 25°C ambient temperature) has been exceeded, the batteries must be replaced. In this case, please contact your dealer.



Be sure to deliver the spent battery to a recycling facility or sh to your dealer in the replacement battery packing material

- **Storage**

Before storing, charge the UPS 5 hours. Store the UPS covered and upright in a cool, dry location. During storage, recharge the battery in accordance with the following table:

Storage Temperature	Recharge Frequency	Charging Duration
-25°C - 40°C	Every 3 months	1-2 hours
40°C - 45°C	Every 2 months	1-2 hours

6. Options

SNMP card: internal SNMP (options)

- Loosen the 2 torquescrews (on each side of the card).
- Carefully insert the SNMP card and lock the screws

The slot called SNMP supports the MEGAtec protocol. This is a tool to remotely monitor and manage any UPS system.

Relaycard (options)

Mini dry contact card is used for providing the interface for UPS peripheral monitoring. The contact signals can reflect UPS running status. The card is connected to peripheral monitoring devices via terminal board to facilitate the effective monitoring of the real-time status of UPS and timely feedback the status to monitor when abnormal situation occurs (such as UPS failure, mains interruption, UPS bypass and ect.). It is installed in the intelligent slot ofthe UPS.

The relaycard includes 6 output ports and one input port.Please refer to the following table for detail.

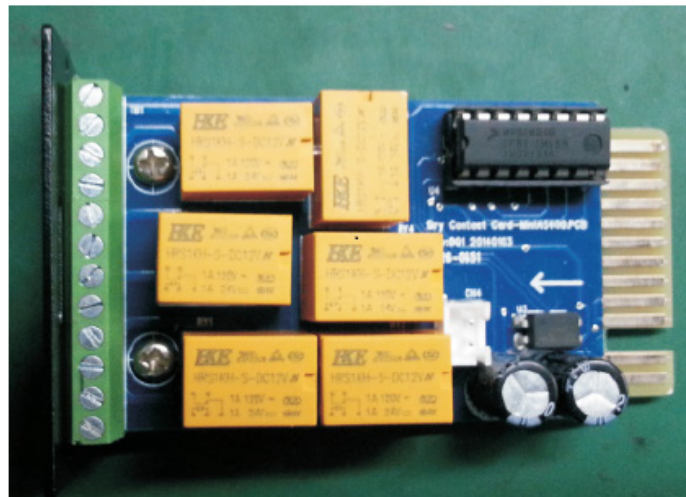

Terminal No.	Terminal function
1	Common source
2	UPS on NO
3	AC fail NO
4	AC fail NC
5	Battery low NO
6	Battery low NC
7	UPS alarm NO
8	UPS alarm NC

Terminal No.	Terminal function
9	Bypass active NO
10	Bypass active NC
11	UPS fail NO
12	UPS fail NC
CN4-1	Remote shutdown
CN4-2	GND

Emergency Power-off (EPO) (options)

EPO is used to shut down the UPS from a distance. This feature can be used for shutting down the load and the UPS by thermal relay, for instance in the event of room overtemperature. When EPO is activated, the UPS shuts down the output and all its power converters immediately. The UPS remains on to alarm the fault.



Note: Depending on user configuration, the pins must be shorted or opened to keep the UPS running. To restart the UPS, reconnect (re-open) the EPO connector pins and turn on the UPS manually. Maximum resistance in the shorted loop is 10 ohm.

Always test the EPO function before applying your critical load to avoid accidental load loss. Leave the EPO connector installed onto the EPO port of the UPS even if the EPO function is not needed.

Load Segments (options)

Load segments are sets of receptacles that can be controlled by power management software or through the display, providing an orderly shutdown and startup of your equipment. For example, during a power outage, you can keep critical equipment running while you turn off other equipment. This feature allows you to save battery power. Each UPS has two load segments:

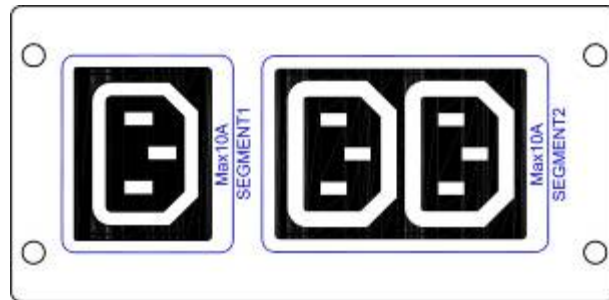

Load Segment 1: The power shedding battery voltage of this segment can be set by LCD.
Load Segment 1: The power shedding battery end of discharge (EOD).

7. Specification

MODEL		1KVA(S)	1.5KVA(S)	2KVA(S)	3KVA(S)
PHASE		Single phase with ground			
Capacity (VA/Watts)		1000 VA / 1000 W	1500 VA / 1500 W	2000 VA / 2000 W	3000 VA / 3000W
INPUT					
Nominal voltage		208/220/230/240VAC			
Operating voltage range (Ambient Temp. <40 °C)	Low line transfer	176 Vac ± 5 % @ 100 % - 50 % load; 110 Vac ± 5 % @ 50 % - 0 % load;			
	Low line comeback	186 Vac ± 5 % @ 100 % - 50 % load; 120 Vac ± 5 % @ 50 % - 0 % load;			
	High line transfer	264 Vac ± 5 % @ 100 % - 50 % load; 300 Vac ± 5 % @ 50 % - 0 % load;			
	High line comeback	254 Vac ± 5 % @ 100 % - 50 % load; 290Vac ± 5 % @ 50 % - 0 % load;			
Operating frequency range**		40 – 70 Hz			
Power factor		0.99 @ 100 % load (Nominal Input Voltage)			
Bypass voltage range		<p style="text-align: center;">Bypass high voltage point 230-264: setting the high voltage point in LCD from 230 Vac to 264 Vac. (Default: 264 Vac) Bypass low voltage point 170-220: setting the low voltage point in LCD from 170 Vac to 220 Vac. (Default: 170 Vac)</p>			
Generator input		Support			
OUTPUT					
Output voltage*		208/220/230/240 Vac			
Power factor		1.0			
Voltage regulation		±1 %			
Frequency	Line Mode (synchronized range)	46-54 Hz or 56-64 Hz			
	Bat. Mode	(50/60±0.1) Hz			
Crest factor		3:1			
Harmonic distortion (THDv)		≤ 3 % THD with linear load ≤ 5 % THD with non linear load			

Waveform		Pure Sinewave			
Transfer time	AC mode <->Batt. mode	Zero			
	Inverter <-> bypass	4 ms (Typical)			
Efficiency		Up to 90.9% (AC mode) 85 % (DC mode)	Up to 92% (AC mode) 86 % (DC mode)	Up to 92% (AC mode) 86 % (DC mode)	Up to 92.3% (AC mode) 87 % (DC mode)
BATTERY					
Battery Type		12V 9AH	12V 9AH	12V 9AH	12V 9AH
Numbers		2	3	4	6
Backup time		Long run unit depends on the capacity of external batteries			
Typical recharge time (standard modle)		4 hours recover to 90% capacity (Typical)			
Charging voltage		27.4 VDC ±1%	41.1 VDC ±1%	54.8 VDC ±1%	82.2VDC ±1%
Charge current		2A	2A	2A	2A
SYSTEM FEATURES					
Overload	Line Mode	105%~125%: UPS transfer to bypass after 1minute when the utility is normal 125%~130%: UPS transfer to bypass after 30 seconds when the utility is normal >130%: UPS transfer to bypass immediately when the utility is normal			
Short Circuit		Hold Whole System			
Overheat		Line Mode: Switch to Bypass; Backup Mode: Shut down UPS immediately			
Low battery voltage		Alarm and Switch off			
EPO		Shut down UPS immediately			
Audible & Visual alarms		Line Failure, Battery Low, Overload, System Fault			
Comunication interface		USB(or RS232), SNMPcard(optional), Relay card (optional)			

ENVIRONMENTAL				
Operating temperature	0 °C ~ 40 °C			
Storage temperature	-25 °C ~ 55 °C			
Humidity range	20 - 90 % RH @ 0 – 40 °C (non-condensing)			
Altitude	< 1500m			
Noise level	Less than 55dBA at 1 Meter			
PHYSICAL				
Dimension WxDxH (mm)	440*325* 86.5	440*460* 86.5	440*460* 86.5	440*600* 86.5
Net Weight (kg)	11.3	15.5	19.5	26

* Derate to 80% of capacity when the output voltage is adjusted to 208VAC

** Derate to 75% of capacity when the Input voltage frequency out of range (50/60 ± 4 Hz)

*** Product specifications are subject to change without further notice.

This is a Class A product. In home environment, this product may cause radio interference. In this case, the user may be required to take appropriate measures.

Hereby Assmann Electronic GmbH, declares that the Declaration of Conformity is part of the shipping content. If the Declaration of Conformity is missing, you can request it by post under the below mentioned manufacturer address.

www.assmann.com
 Assmann Electronic GmbH
 Auf dem Schüffel 3
 58513 Lüdenscheid
 Germany

