



# **ONLINE UPS SYSTEM**

**DN-170093 Rev. 4 ▪ DN-170094 Rev. 4**  
**DN-170095 Rev. 4 ▪ DN-170096 Rev. 4**

Quick Installation Guide

# 1. Important safety warning

## Important safety instructions – Save these instructions

Please comply with all warnings and operating instructions in this manual strictly. Save this manual properly and read carefully the following instructions before installing the unit. Do not operate this unit before reading through all safety information and operating instructions carefully.

There exists dangerous voltage and high temperature inside the UPS. During the installation, operation and maintenance, please abide the local safety instructions and relative laws, otherwise it will result in personnel injury or equipment damage. Safety instructions in this manual act as a supplementary for the local safety instructions. Our company will not assume the liability that caused by disobeying safety instructions.

### 1.1 Transportation

- Please transport the UPS system only in the original package to protect against shock and impact.

### 1.2 Preparation

- Condensation may occur if the UPS system is moved directly from cold to warm environment. The UPS system must be absolutely dry before being installed. Please allow at least two hours for the UPS system to acclimate the environment.
- Do not install the UPS system near water or in moist environments.
- Do not install the UPS system where it would be exposed to direct sunlight or near heater.
- Do not block ventilation holes in the UPS housing.

### 1.3 Installation

- Do not connect appliances or devices which would overload the UPS system (e.g. laser printers) to the UPS output sockets.
- Place cables in such a way that no one can step on or trip over them.
- Do not connect domestic appliances such as hair dryers to UPS output sockets.
- The UPS can be operated by any individuals with no previous experience.
- Connect the UPS system only to an earthed shockproof outlet which must be easily accessible and close to the UPS system.
- Please use only VDE-tested, CE-marked mains cable (e.g. the mains cable of your computer) to connect the UPS system to the building wiring outlet (shockproof outlet).
- Please use only VDE-tested, CE-marked power cables to connect the loads to the UPS system.
- When installing the equipment, it should ensure that the sum of the leakage current of the UPS and the connected devices does not exceed 3.5mA.

## 1.4 Symbols used in this guide



### CAUTION!

Read this information to avoid equipment damage

## 2. Installation and setup

**Note:** Before installation, please inspect the unit. Be sure that nothing inside the package is damaged. Please keep the original package in a safe place for future use.

### 2.1 Unpack checking

1. Don't lean the UPS when moving it out from the packaging
2. Check the appearance to see if the UPS is damaged or not during the transportation, do not switch on the UPS if any damage found. Please contact the dealer right away.
3. Check the accessories according to the packing list and contact the dealer in case of missing parts.

It includes:

- 1 x UPS User Guide
- 1 x UPS Quick Installation Guide
- 1 x Software download license
- 1 x USB cable
- 2 x power cables (input and output)

### 2.2 UPS Module Outlook

1 kVA:

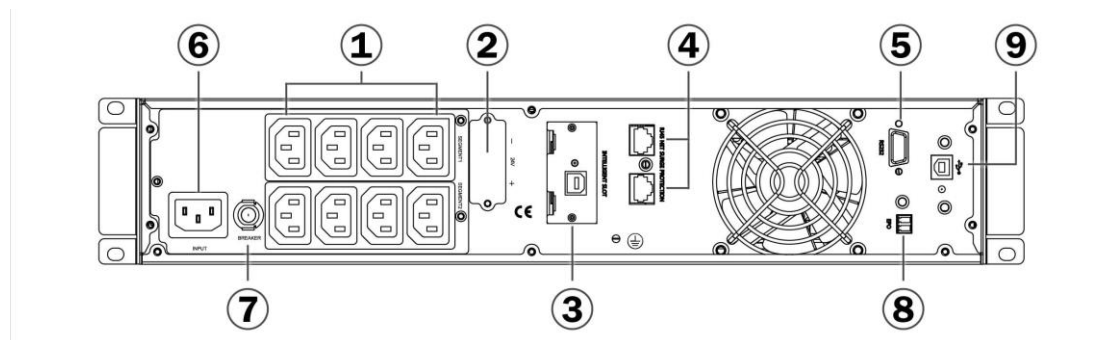

1.5 kVA:

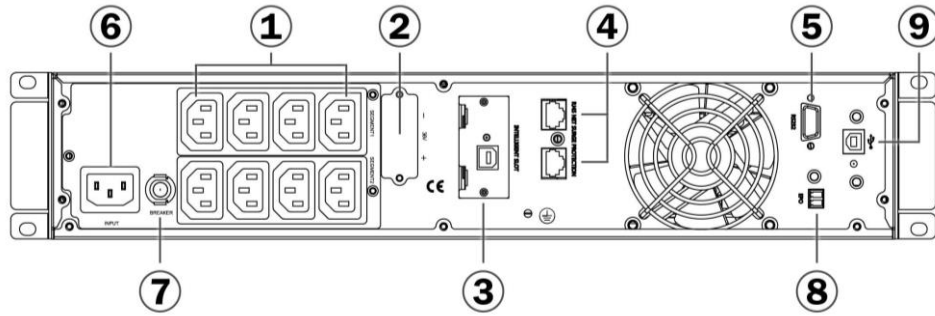

2 kVA:

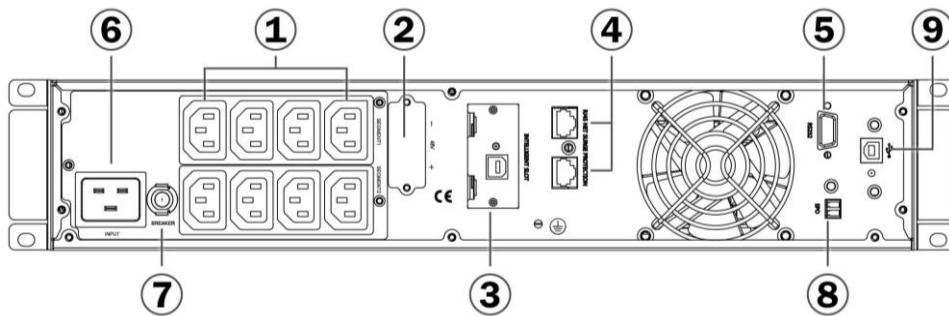

3 kVA:

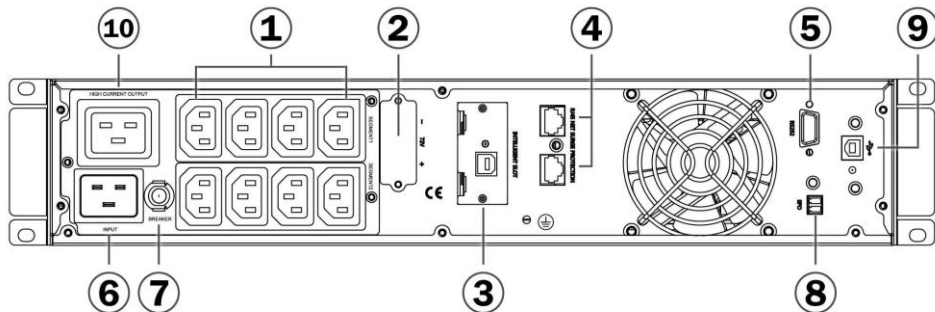

- (1) Output receptacles (10 A)
- (2) Battery terminal
- (3) SNMP intelligent slot
- (4) RJ45 Surge Protection
- (5) RS-232 communication port

- (6) AC input receptacle
- (7) Input circuit breaker
- (8) EPO (with Jumper cap)
- (9) USB
- (10) Output receptacle (16 A)

## 2.3 Installing the UPS

- **Rackmount installation**

The Rackmount cabinet comes with all of the hardware required for installation in a standard EIA or JIS seismic Rackmount configuration with square and round mounting holes.

CAUTION	
	The cabinet is heavy. Removing the cabinet from its carton requires a minimum of two people.
	If installing optional EBP(S), make sure to install the EBP(S) directly below the UPS so that all wiring between the cabinets is installed behind the front covers and inaccessible to users.
	<b>Note:</b> Optional mounting rails are required for each individual cabinet.

- **Rackmount converted to tower installation**

- (1) Two plastic base brackets
- (2) Flatten it after intercrossing

Intercross as following figure:

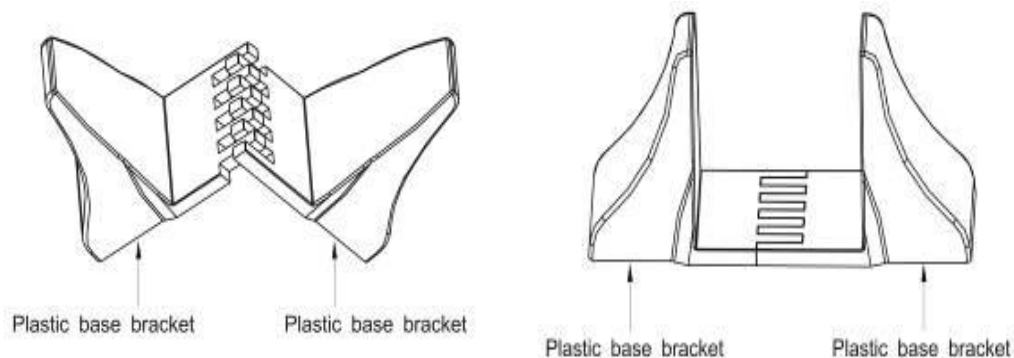

- **Battery Installation**

**Note:** Do not make unauthorized changes to the ups; otherwise, damage may occur to your equipment and void your warranty.

**Note:** Do not connect the ups power cord to utility until after installation is completed.

- a) Remove the front cover of each UPS

Press the cover side with LCD display, hold the other side and quickly extract it, then extract the other side with display. (see Figure 1)

**Note:** A ribbon cable connects the LCD control cover to the UPS. Do not pull on the cable or disconnect it.

When remove the cover, operate as the following right Figure shows instead of the left one. (see Figure 1)

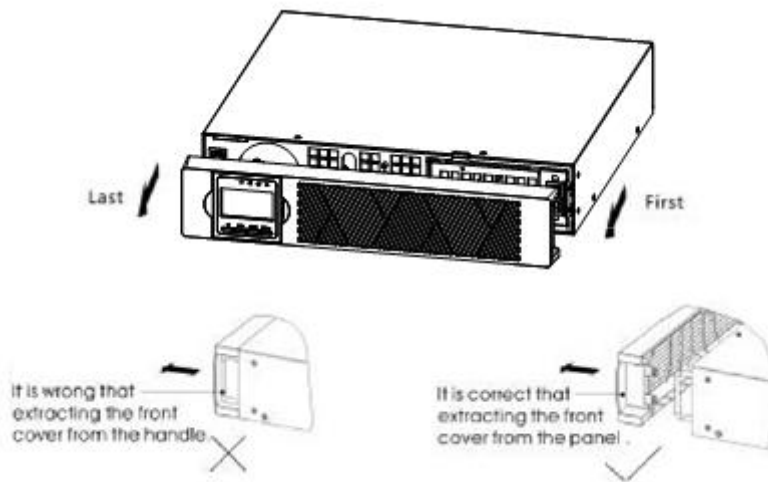



Figure 1: Extract the UPS front cover

<b>CAUTION</b>	
	<p>A small amount of arcing may occur when connecting the internal batteries. This is normal and will not harm personnel. Connect the cables quickly and firmly.</p>

- b) Connect the internal battery connector (see Figure 2). Connect red to red, Press the connector tightly together to ensure a proper connection.

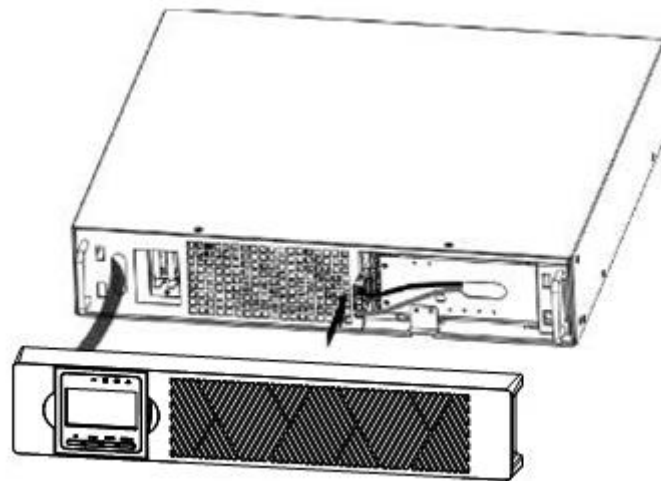

Figure 2: Connecting the UPS internal batteries

- c) Replace the UPS front cover

To replace the cover, verify that the ribbon cable is protected.

Put the front cover hooks of side with display to the cover port, put another side to the other two ports, then press it until the cover and the chassis are combined tightly.

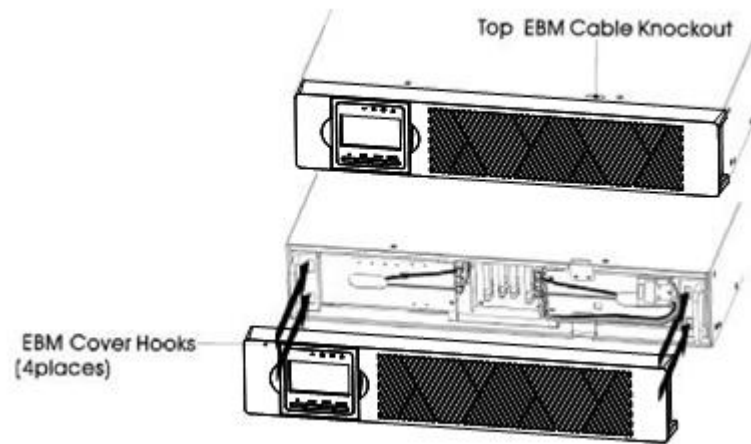

Figure 3

## 2.4 Setup the UPS

### Step 1: UPS input connection

Plug the UPS into a two-pole, three-wire, grounded receptacle only. Avoid using extension cords.

- For 208/220/230/240VAC models: The power cord is supplied in the UPS package

### Step 2: UPS output connection

- For socket-type outputs, simply connect devices to the outlets.
- For terminal-type input or outputs, please follow below steps for the wiring configuration:
  - a) Remove the small cover of the terminal block
  - b) Suggest using AWG14 or 2.1mm<sup>2</sup> power cords for 3KVA (208/220/230/240VAC models).
  - c) Upon completion of the wiring configuration, please check whether the wires are securely affixed.
  - d) Put the small cover back to the rear panel.

### Step 3: Communication connection

#### Communication port

**USB port**



**RS-232 port**

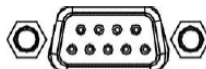

**Intelligent slot**



To allow for unattended UPS shutdown/start-up and status monitoring, connect the communication cable one end to the USB/RS-232 port and the other to the communication port of your PC. With the monitoring software installed, you can schedule UPS shutdown/start-up and monitor UPS status through PC.

The UPS is equipped with intelligent slot perfect for either SNMP or Relay card. When installing either SNMP or Relay card in the UPS, it will provide advanced communication and monitoring options.

**Note:** USB port and RS-232 port can't work at the same time.

**Note:** Using the provide USB cable is required. (RS232 cable is optional.)

#### Step 4: Turn on the UPS

Press the ON button on the front panel for two seconds to power on the UPS.

**Note:** The battery charges fully during the first five hours of normal operation. Do not expect full battery run capability during this initial charge period.

#### Step 5: Install software

For optimal computer system protection, install UPS monitoring software to fully configure UPS shutdown. You may insert provided CD into CD-ROM to install the monitoring software. You may follow the Software License Card instruction to install the monitoring software.

**Note:** The software product SN. can be only allowed for one PC installation.







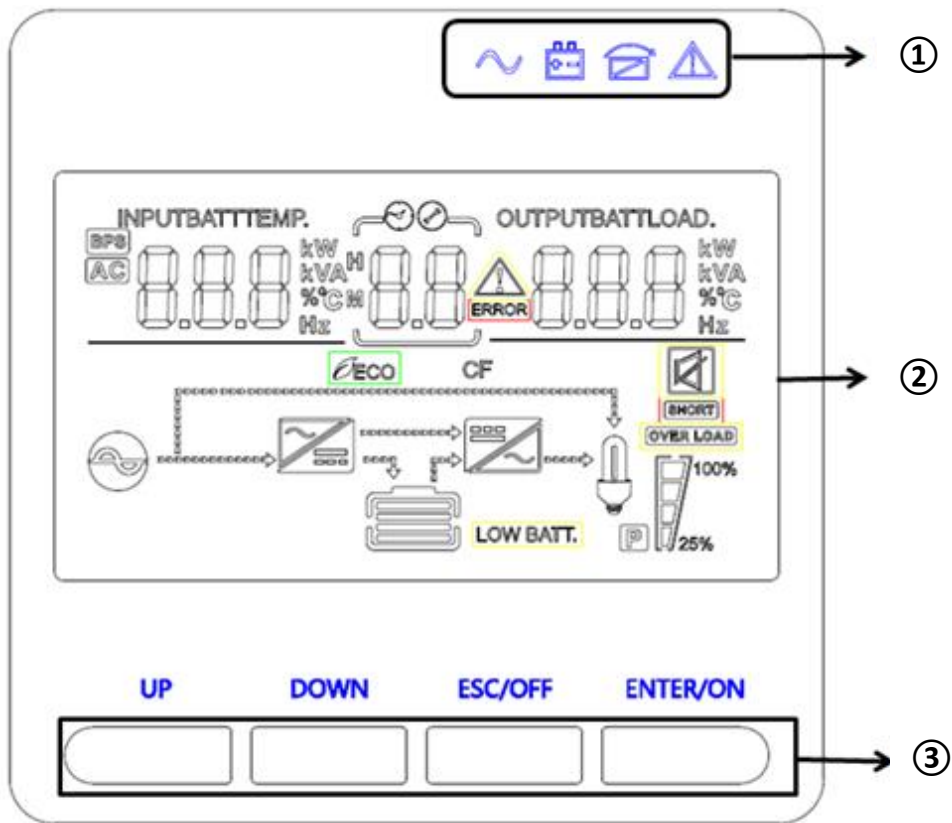

## 2.5 Operation and display panel



- ① LED (from right to left: "alarm", "bypass", "battery", "inverter")
- ② On-Line UPS LCD display
- ③ Function keys

## LED indicator

Indicator	Description
 Red	<b>ON:</b> The UPS has an active alarm or fault
 Yellow	The UPS is in Bypass mode. <b>ON:</b> The UPS is operating normally on bypass during High Efficiency operation.
 Yellow	<b>ON:</b> The UPS is in Battery mode.
 Green	<b>ON:</b> The UPS is operating normally.
<p><b>Note:</b> When power on or startup, these indicators will turn on and off sequentially.  <b>Note:</b> On different operation modes, these indicators will indicate differently.</p>	

## Function Keys

Function key	Description
ESC/OFF	To exit setting mode or turn off the UPS
UP	To go to previous selection or turn on the UPS
DOWN	To go to next selection
ENTER/ON	To confirm the selection in setting mode or enter setting mode

## 3. Operations

### 3.1 Button operation

Button	Function
ON/ENTER	<ul style="list-style-type: none"> <li>Turn on the UPS: Press and hold ON button for at least 2 seconds to turn on the UPS.</li> </ul>
OFF/ESC	<ul style="list-style-type: none"> <li>Turn off the UPS: Press and hold this button at least 2 seconds to turn off the UPS in battery mode. UPS will be in standby mode under power normal or transfer to Bypass mode if the Bypass enable setting by pressing this button.</li> </ul>

UP	<ul style="list-style-type: none"> <li>Up key: Press this button to display previous selection in UPS setting mode.</li> </ul>
DOWN	<ul style="list-style-type: none"> <li>Down key: Press this button to display next selection in UPS setting mode.</li> <li>To confirm selection and exit setting mode: Press this button to confirm selection and exit setting mode when LCD display the last selection in UPS setting mode.</li> </ul>
UP + DOWN	<ul style="list-style-type: none"> <li>Setting mode: Press and hold this button for 5 seconds to enter UPS setting mode.</li> </ul>

### 3.2 UPS startup and turn off

- **Startup operation**

(1) Turn on the UPS in line mode

**Note:** Verify that the total equipment ratings do not exceed the UPS capacity to prevent an overload alarm.

- Once mains power is plugged in, the UPS will charge the battery, at the moment, the LCD shows that the output voltage is 220, which means the UPS automatically start the inverter. If it is expected to change to bypass mode, you can Press "OFF" key.
- Press and hold the ON key for more than three seconds to start the UPS, then it will start the inverter.
- Once started, the UPS will perform a self-test function, LED will light and go out circularly and orderly. When the self-test finishes, it will come to line mode, the corresponding LED lights, the UPS is working in line mode.

(2) Turn on the UPS by DC without mains power

- When mains power is disconnected, press and hold the ON key for more than half a second to start UPS.
- The operation of the UPS in the process of start is almost the same as that when mains power is in. After finishing the self-test, the corresponding LED lights and the UPS is working in battery mode.

- **Turn off operation**

(1) Turn off the UPS in line mode

- Press and hold the OFF key for more than half a second to turn off the UPS and inverter.
- After the UPS shutdown, the LEDs go out and there is no output. If output is needed, you can set bps "ON" on the LCD setting menu.

- (2) Turn off the UPS by DC without mains power
  - a) Press and hold the OFF key for more than half a second to turn off the UPS.
  - b) When turning off the UPS, it will do self-testing firstly. The LEDs light and go out circularly and orderly until there is no display on the cover.

## 4. Storage

Before storing, charge the UPS 5 hours. Store the UPS covered and upright in a cool, dry location. During storage, recharge the battery in accordance with the following table:

Storage Temperature	Recharge Frequency	Charging Duration
-25°C - 40°C	Every 3 months	1-2 hours
40°C - 45°C	Every 2 months	1-2 hours

This is a Class A product. In home environment, this product may cause radio interference. In this case, the user may be required to take appropriate measures.

Hereby Assmann Electronic GmbH, declares that the Declaration of Conformity is part of the shipping content. If the Declaration of Conformity is missing, you can request it by post under the below mentioned manufacturer address.

**www.assmann.com**  
 Assmann Electronic GmbH  
 Auf dem Schüffel 3  
 58513 Lüdenscheid  
 Germany

