



SMART FULL HD OUTDOOR CAMERA



Manual

DN-18600

1. Safety Precautions

- Only use the camera within the specified temperature range
- When not in use, store the product in a clean and dry place in temperatures between 0°C and 40°C
- Do not cover the camera
- Do not let the indoor devices come into contact with liquids (except outdoor cameras with IP66 protective cover)
- The camera does not replace adult supervision. Safeguard the health of your children, family members or pets by regularly looking after them
- Install the camera in close proximity to an easily accessible wall outlet. Ensure that the power cord is not under tension or stretched
- Position the camera within the range of your Wi-Fi router and ensure that there are no obstacles between camera and router, which could interfere with the Wi-Fi signal
- Protect the camera from electrical and other HF devices generating interferences (microwaves, mobile phones, etc.)
- Keep camera and power cord outside the reach of children, since these components can be dangerous

- Only use the supplied power adapter.
- Never try to repair the system by yourself. Repair and maintenance work must be carried out by specialists.
- In case of problems contact our customer service.
- Observe all applicable laws regarding camera monitoring. The camera is intended for private use at home. Inform your family members, relatives and domestic helpers in your household with regard to video monitoring. Ensure that public areas and your neighbors' properties cannot be seen.

2. Personal Information

- Read and accept the privacy policy of Smart Life Platform inside the App
- Select a password with a high degree of safety for your Smart Life account to protect it from unauthorized access
- The password should contain at least 6 characters; we recommend case-sensitive letters and alphanumeric characters



Privacy Policy of Smart Life Platform

Update date: 2018.4

Come into force date: 2018.5

So you have purchased our Smart LifeSmart device hardware and are starting to use the Smart LifeSmart device software and all its functionalities! Any information you share with us (e.g. for creating a Smart Life Account) will help us to provide you with services related to Smart LifeSmart device and to improve them to make them even better. We explain here our ways of collecting and using information, and how we protect your privacy. In this privacy policy, "personal data" means information that can be used to identify an individual, either from that information alone, or from that information and other information we have access to about that individual. We collect both personal and non-personal data to enable and facilitate the best user experience possible

What information is collected and how do we use it?

In order to provide our services to you, we will ask you to provide necessary personal data that is required to provide those services. If you do not provide your personal data, we may not be able to provide you with our products or services.

1. Smart Life Account Information

Personal data that are collected while creating a Smart Life Account may include PII information like your email address or mobile phone number. These information help to activate, manage and get service of Smart Life. Your nickname, profile picture, country and time zone will be connected to your account so that you can visit our product and service conveniently.

2. User Device Information

Your device model, operation system, unique device identifier, IP address, Smart Life software version number, access type and model etc. will be collected for you can receive PUSH. And those are very necessary basic information which we have to collect from you.

3. Device Information

Disagree

Agree

3. What's in the box?

DN-18600

- 1 x Smart Full HD Outdoor Camera
- 1 x Micro USB connection cable
- 1 x Magnet bracket
- Quick Installation Guide

Thank you for choosing DIGITUS® Smart Full HD Outdoor Camera, which can be up-and-running quick and easy without complicated network settings.

4. Hardware description

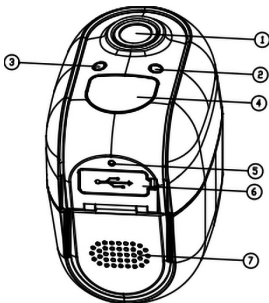

- | | |
|----------------------------|------------------|
| 1. Lens | 5. Mic |
| 2. LED | 6. USB Interface |
| 3. Light sensor | 7. Speaker |
| 4. Motion Detection sensor | |

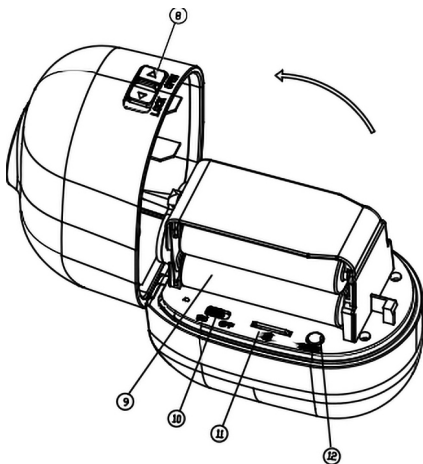

8. Flip switch

9. AA battery

10. Power switch

11. Micro-SD card

12. Reset button

5. Setting up the Smart Life User Account

In order to use your DIGITUS® Smart Full HD Outdoor Camera, you need to register an user account. The setup and control can be done from your Smartphone/tablet, with Android system 4.4.2 and above, or iOS system 8 and above.

Create a user account with your Smartphone/tablet

If you have an Apple® iOS device, then you will find the "Smart Life" App on the Apple App Store®. For Smartphones and tablets running on Google Android OS you can find the "Smart Life"-App in the Google™ Play Store. In the search field of the respective App Stores® enter "Smart Life".

Apple App Store®



Google™ Play

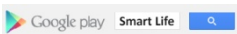

In the Search results the "Smart Life"-App will be marked with this symbol.



Then please download and install the App on your mobile device.

You can also scan below QR code to download and install the app.



Apple App Store®



Google™ Play

Start the App and you will enter the login page. For first time user, please create your account by “Register”

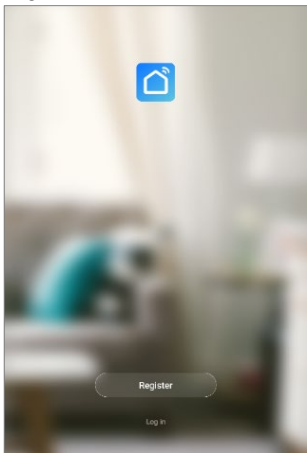

Create new account with Smart Life

Click on "Register".

1. Please enter your email or phone number, which would be your login account.
2. Accept the Service Agreement and Privacy Policy
3. Press "Continue", you will receive a verification code by email or SMS. You will receive the email or SMS immediately. If you do not receive the email, please check your Spam Folder. If you do not receive the SMS, please check your registered phone number

← **Register**

Register

Germany +49 >

Mobile number/Email

Continue

I agree with [Service Agreement](#) and [Privacy Policy](#)

4. Enter verification code

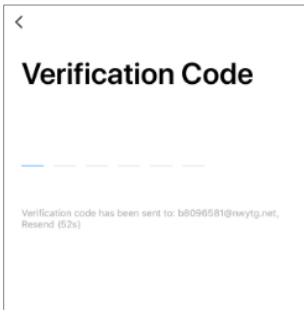

A mobile app screen titled "Verification Code". At the top left is a back arrow. Below the title is a horizontal dashed line with the first dash highlighted in blue. At the bottom, there is a message: "Verification code has been sent to: b8096581@nwytg.net, Resend (52s)".

5. Create a password that you can remember.
(Alphabet and numerical characters are supported).

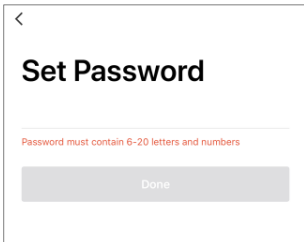

A mobile app screen titled "Set Password". At the top left is a back arrow. Below the title is a horizontal line. Below the line is a red error message: "Password must contain 6-20 letters and numbers". At the bottom is a grey button labeled "Done".

6. Please enter a name, which you can choose freely (e.g. home). Optionally, you can now also determine the location and in which room your socket is used.

← Add Home Done

Name Enter your home name

Location Set geographic location >

Smart devices in:

- Living Room ✓
- Master Room ✓
- Second Bedroom ✓
- Dining Room ✓
- Kitchen ✓
- Study Room ✓

[Add another room](#)

You can change the home settings at any time

6. Connect the camera to your Wi-Fi

With Smartphone/tablet

1. Please put the flip switch to “open” position and open the cover, then install four pcs AA battery in it. (Please notice the polarity of the battery) Next put the power switch to “ON” position, press the RESET button for 5 seconds. When red and blue lights flash slowly, the device is ready to connect.

Please tap the “+” icon or tap “Add Device” in the app and follow the instructions in the app to connect your DIGITUS® Smart Full HD Outdoor Camera to your WiFi.

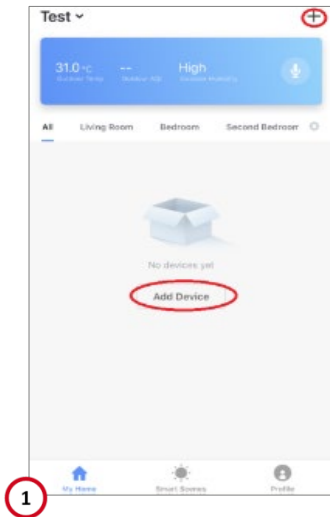

2. Please select “Security & Sensor” and afterwards “Smart Camera” to start.

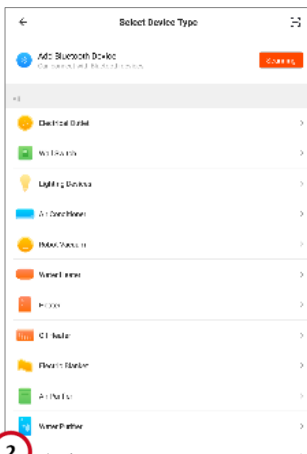

3. Confirm that the LED is fast blinking.

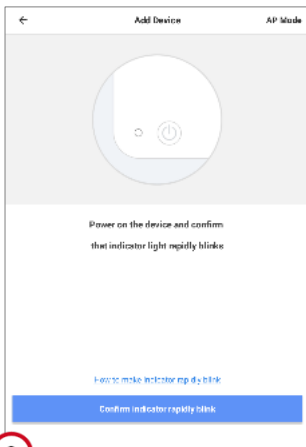

4. Your WiFi's SSID will be shown to connect with. Please make sure, your mobile device is connected to your 2.4GHz WiFi network. 5GHz WiFi networks will not be supported. Please key in the password for your router/AP at home.

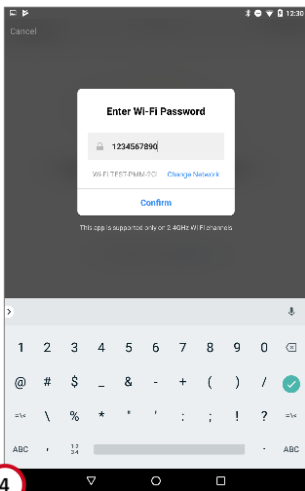

5. A QR-code will be automatically generated in the app, as shown in the picture. Let the QR-code aim at the cameras lens, keep their distance at around 15cm – 30cm. When hear a “beep” sound and see the red light turn blue, click “I heard the beep”.

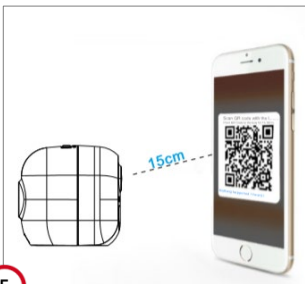

5

6. The DIGITUS® Smart Full HD Outdoor Camera is now connecting to your WiFi network.

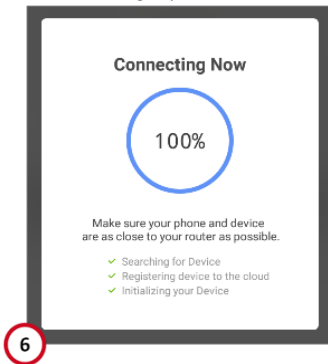

7. For the use with a voice controlled system like Amazon Alexa or Google Home, we recommend to give the camera an identifiable name, e.g. main entrance.

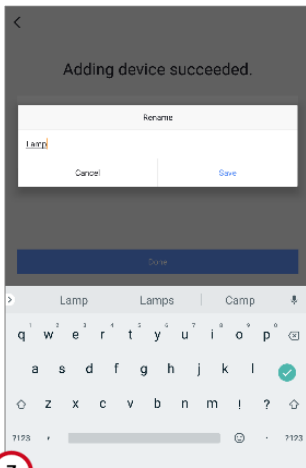

Once the camera is renamed, press “Save” and “Done” to submit the changes.

8. You will be linked to the main menu.

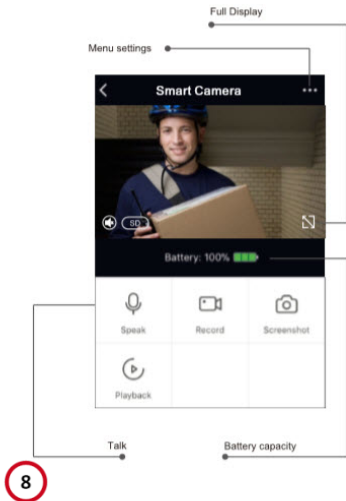

Now you can use your DIGITUS® Smart Full HD Outdoor Camera.

7. How to link the Camera with Amazon Alexa / Google Assistant

How to link the camera with Amazon Alexa

1. Please open the “Amazon Alexa” App on your Smartphone / Tablet, log into your Amazon Alexa account and select “Skills” from the menu list.

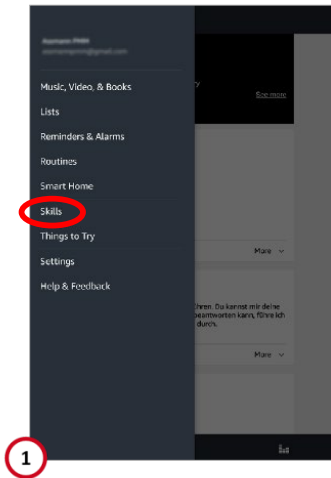

2. Please enter “Smart Life” in the search field and chose the Smart Life skill from the list.

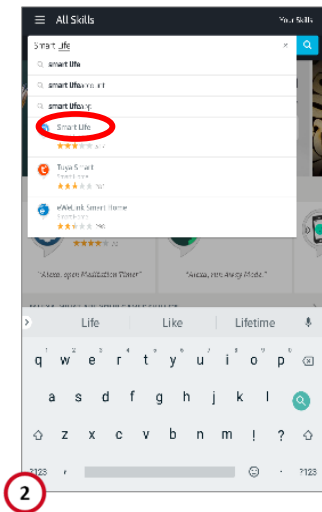

3. Please enable the Smart Life skill and move forward with the account linking.

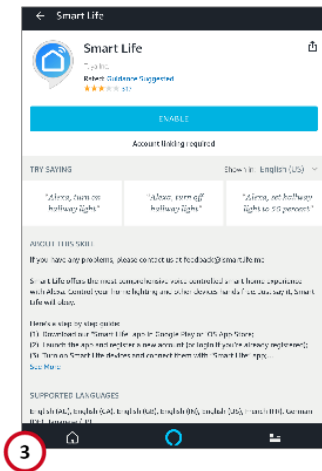

4. To activate the account linking, please enter your Smart Life App account information and press “Link Now”.

The screenshot shows a mobile application interface titled "Account Binding" with the URL "https://aql.tuya.com". At the top right, there is a "Station" dropdown menu. Below it is a blue house icon with a Wi-Fi signal. The form contains the following elements:

- Account:** A dropdown menu showing a German flag and "+49", followed by a text input field labeled "Phone Number/Email Address".
- Password:** A text input field with the placeholder "Type your password here" and a toggle icon for visibility.
- Link Now:** A large grey button.
- Target Password:** A link in red text.
- SMS Login:** A link in red text.
- Sign in with social media account:** Text centered above a Twitter logo.

4

5. Now please authorize Amazon Alexa to control your devices over the internet by pressing “Authorize”.

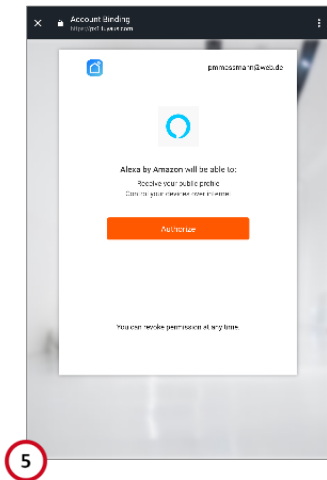

6. After the successful link, the Amazon Alexa App can discover your smart home devices.

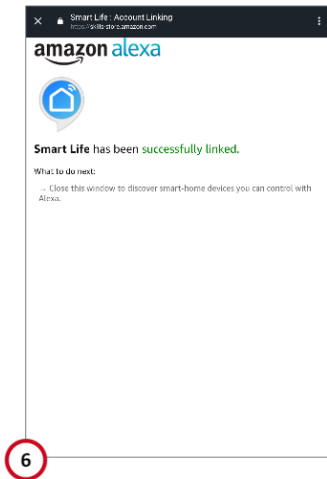

7. Please press “Discover” to search for your linked devices.

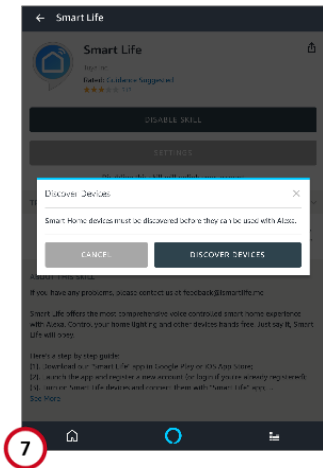

8. Alexa is now discovering your devices...

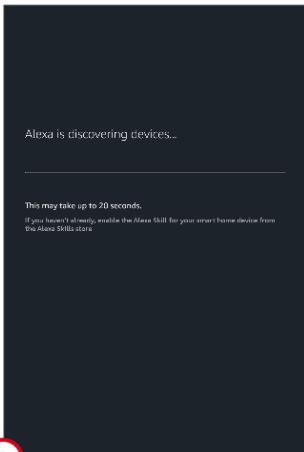

8

9. After successful discovery of your devices, the devices will be listed in the Smart Home menu. Now you can start to control DIGITUS® Smart Full HD Outdoor Camera via Amazon Alexa. Simply ask Alexa (e.g.) to show the main entrance.

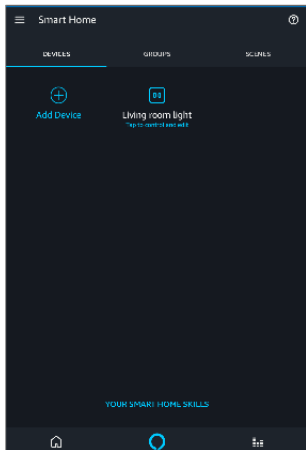

9

How to link camera with Google Home

1. Please open the “Google Home” App on your Smartphone / Tablet, log into your Google Home account and select “Home control” from the menu list.

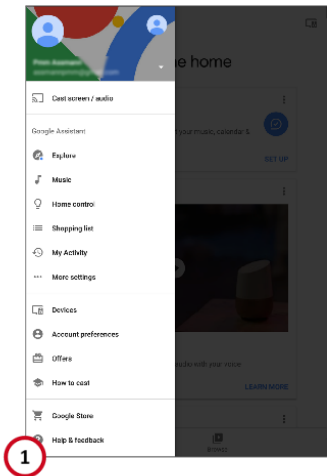

2. Please press the “+” icon to add the control DIGITUS® Smart Full HD Outdoor Camera.



3. Search for Smart Life and add the Smart Life action.

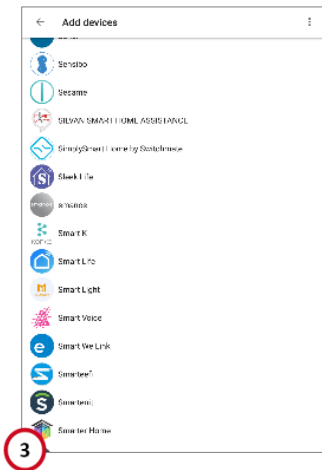

4. To activate the account linking, please enter your Smart Life App account information and press “Link Now”.

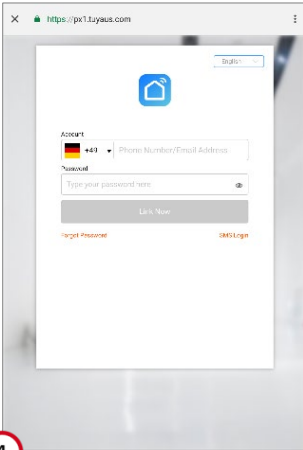

The screenshot shows a mobile browser window with the URL <https://px1.tuyaus.com>. The page features a blue Smart Life app icon at the top. Below the icon is a form for account linking. The form includes a dropdown menu for the country (currently set to Germany with a +49 prefix) and a text input field for the phone number or email address. Below this is a password field with the placeholder text "Type your password here" and a visibility toggle icon. A prominent grey "Link Now" button is centered below the password field. At the bottom of the form, there are two links: "Forgot Password" on the left and "SMS Login" on the right. A red circle with the number "4" is overlaid on the bottom left corner of the screenshot.

5. Now please authorize Google Home to control your devices over the internet by pressing "Authorize".

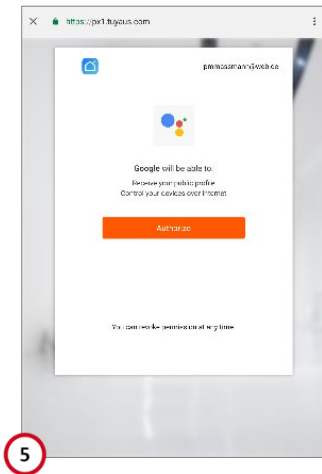

6. After the successful link, Google Home will discover your smart home devices.

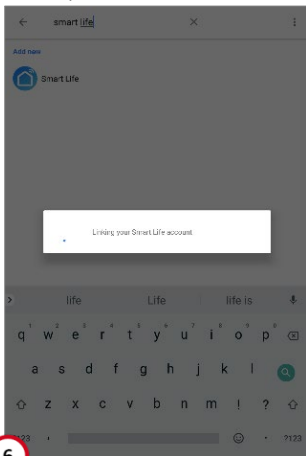

7. Your device will be shown and you can edit the name and assign a room.

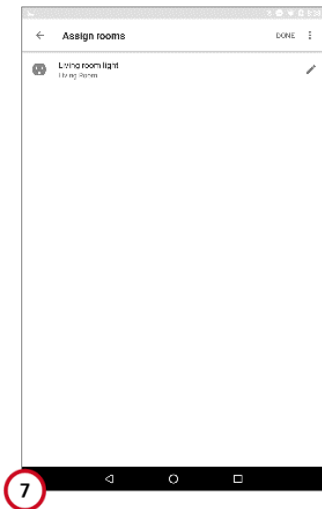

8. Now you can start to control your control DIGITUS® Smart Full HD Outdoor Camera via Google Home. Simply ask Google Home (e.g.) to show the main entrance.

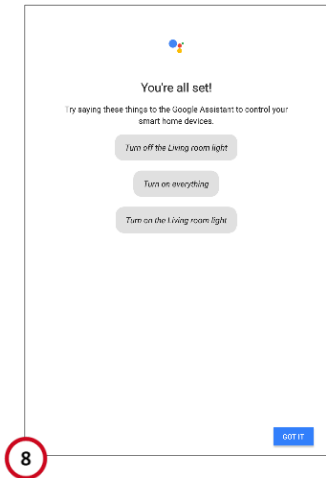

8. Technical Description

- Frequency Range: 2412 – 2472 MHz
- Transmit Power: <20 dBm
- Software Version: V1.0.3.26
- Hardware Version: Ver2.0

9. Declaration

Amazon, Alexa and all related logos are trademarks of Amazon.com, Inc. or its affiliates.

Android, Google, Google Home and Google play are registered trademarks of Google Inc.

AVM Fritz!Box is a registered trademark of AVM Computersysteme Vertriebs GMBH.

Telekom Speedport is a registered trademark of Deutsche Telekom AG.

App Store is a service mark of Apple Inc., registered in the U.S. and other countries. IOS is a trademark or registered trademark of Cisco in the U.S. and other countries and is used under license.

Google Play and the Google Play logo are trademarks of Google Inc.

Note:

All other trademarks not listed here, are the property of their respective owners.

Trademarks or trade names mentioned in this manual are used to describe the operating steps and do not imply that they are freely available. In any case they are the property of the respective holder of the rights.

To access the other languages of QIGs, please visit our website to download the documents.

Hereby ASSMANN Electronic GmbH declares that the Declaration of Conformity is part of the shipping content. If the Declaration of Conformity is missing, you can request it by post under the below mentioned manufacturer address.

www.assmann.com

Assmann Electronic GmbH

Auf dem Schüffel 3

58513 Lüdenscheid

Germany

