



**Full HD
WDR Mini Dome
IP Camera**



User's Manual

DN-16086

Ver. 1.0

Table of Contents

1. Overview	2
1.1 Features	2
1.2 Package Contents	3
1.3 Dimensions.....	4
1.4 Installation	5
1.5 Connectors	7
2. Camera Cabling.....	8
2.1 Connect Ethernet Cable	8
3. System Requirements	10
4. Access Camera	11
5. Setup Video Resolution.....	14
6. Configuration Files Export / Import.....	15
7. Tech Support Information	16
7.1 Delete the Existing Viewer	16
7.2 Setup Internet Security.....	17

Appendix: Technical Specifications

1. Overview

DN-16086 offers high definition resolution at full frame rate with progressive scan technology and edge enhancement for outstanding picture clarity. ONVIF (Profile S) compliance ensures hassle-free and flexible system integration. The camera is capable of serving real-time streaming and makes image quality more smoothly. In addition to MJPEG real time streaming, this camera develops H.264 codec to apply for high resolution digital broadcast. With Shutter WDR function, the camera can provide better image quality under extreme light contrast scenarios or changing lighting environments.







This Mini-Dome IP Camera is a cost-effective surveillance solution for installations that require excellent picture quality at minimal bandwidth. Their simple yet solid, low-profile design is ideal for discreet installations where space is limited. Installation and setup is simple, quick and easy, with a factory-focused lens and a simple PoE connection.

1.1 Features

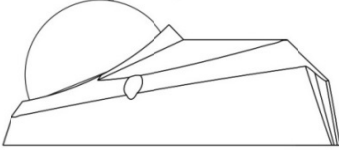
- Sony Progressive Scan CMOS Sensor
- 2MP Resolution
- Quad Streams Support
- Dual Streams, Full HD 1080P Real-Time + Full HD 1080P Real-Time
- Quad Stream Compression-
H.264 Baseline / Main / High Profile + MJPEG
- Multi-language Support
- Smart Event Function-
Motion Detection / Network Failure Detection / Tampering Alarm / Periodical Event / Manual Trigger / Face Detection / Audio Detection
- Ultra Dynamic Range
- Privacy Masks
- 3D Noise Reduction / 2D Noise Reduction
- Digital Image Stabilization (DIS)
- Weatherproof RJ-45 Cable
- Weatherproof (IP66 international)*
- microSD Support
- ONVIF Support

1.2 Package Contents

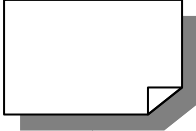
Please check the package containing the following items listed below.

 <p>Full HD Multi-Streams Ultra-WDR Micro Dome IP Camera Indoor / Outdoor (with Cable)</p>	 <p>Rubber Washer (x1, Casing) Rubber Washers (x3, Baseplate) (Outdoor Camera only)</p>
 <p>Self-tapping screws (x3)</p>	 <p>Plastic Anchors (x3)</p>
 <p>Security Torx</p>	 <p>Quick Guide</p>
 <p>CD</p>	



NOTE: The supplied self-tapping screws are for soft substances / materials such as wood. For other installation environments such as cement wall, it is required to pre-drill and use plastic anchors before fastening the supplied self-tapping screws on the wall.

1.3 Dimensions

The dimensions of the camera are shown below.

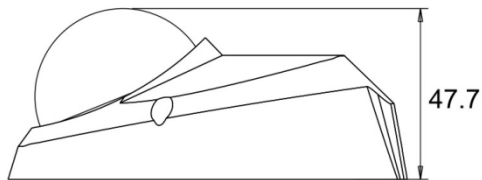
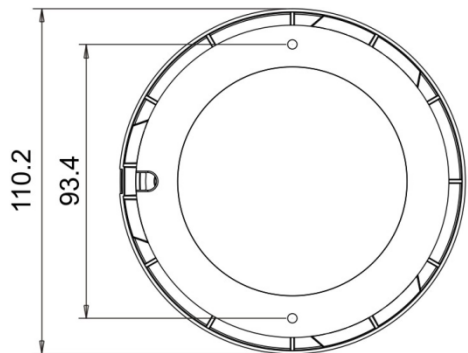

Unit: mm

1.4 Installation

Please follow the steps below to install the outdoor camera.

Step 1:

Loosen the two security screws of the camera and detach the dome cover.



Step 2:

At the two sides of the base plate, place a rubber washer on the screw hole shown in the right figure.

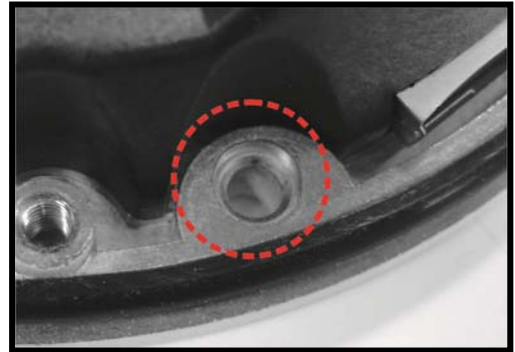

Step 3:

Place the camera at the installation location. Then attach the camera to the ceiling by fastening the supplied screws to the screw holes with the rubber washers.



Step 4:

Refer to section [Connectors](#) and chapter [Camera Cabling](#) for camera lens adjustment and cable connection.

Step 5:

Attach the dome cover back to the camera and fasten the two security screws.



1.5 Connectors

The diagram below shows the reset button, lens, microSD card slot and built-in microphone of the camera. Definition of each connector is given as follows.



No.	Designation	Description
1	microSD Card Slot	Insert the microSD card into the card slot to store videos and snapshots. Do not remove the microSD card when the camera is powered on.
2	Default Button	Press the button with a proper tool for at least 20 seconds to restore the system.
3	Built-in Microphone (Indoor Only)	The built-in microphone is for audio in.



NOTE: It is not recommended to record with the microSD card for 24/7 continuously, as it may not be able to support long term continuous data read/write. Please contact the manufacturer of the microSD card for information regarding the reliability and life expectancy.

2. Camera Cabling

Before users connect cables, make sure that all cables and the power adaptor are placed in dry and well-waterproofed environments, e.g. waterproof boxes. The purpose is to prevent moisture accumulation inside the camera and moisture penetration into cables, which might lead to camera breakdown. Please follow the instructions below to complete camera connection.

2.1 Connect Ethernet Cable

Refer to the camera type and follow the instructions to connect Ethernet cable.

2.1.1 Outdoor Camera

The RJ-45 cable of the outdoor camera is an IP66 RJ-45 cable. Refer to the instructions below to connect Ethernet cable and waterproof connector.



IP66 RJ-45 Cable

IP66 RJ-45 Cable

For IP66 RJ-45 cable, please use an RJ-45 IP66 plug for connection to prevent water damage. Follow the steps below for cable connection.

Step 1:

Take out the supplied connector from the RJ-45 IP66 plug. Loosen the thread-lock sealing nut on the plug. Then thread the Ethernet cable through the thread-lock sealing nut and the plug. If the Ethernet cable is already attached to a connector, please remove it first.

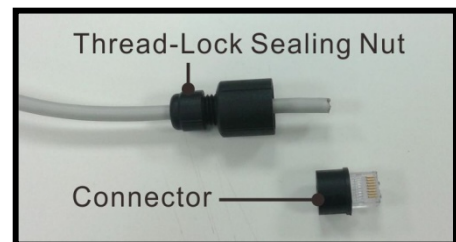

Step 2:

Carefully remove a section of rubber coating from the end of the Ethernet cable to reveal the wires. Inset the wires to the correct pins of the connector. Plug the Ethernet cable to the connector of IP66 RJ-45 cable.



Step 3:

Fasten the RJ-45 IP66 plug to the connector of the IP66 RJ-45 cable. Lastly, tighten the thread-lock sealing nut to the plug.



Step 4:

Connect the other end of the Ethernet cable to a waterproof PoE switch / hub.

3. System Requirements

To perform the IP camera via web browser, please ensure the PC is in good network connection, and meet system requirements as described below.

Items	System Requirement
Personal Computer	1. Intel® Pentium® M, 2.16 GHz or Intel® Core™ 2 Duo, 2.0 GHz 2. 2 GB RAM or more
Operating System	Windows VISTA / Windows XP / Windows 7
Web Browser	Microsoft Internet Explorer 6.0 or later Firefox Chrome Safari
Network Card	10Base-T (10 Mbps), 100Base-TX (100 Mbps) or 1000Base-T (1000 Mbps) operation
Viewer	ActiveX control plug-in for Microsoft IE

4. Access Camera

For initial access to the IP camera, users can search the camera through the installer program: DeviceSearch.exe, which can be found in “DeviceSearch” folder in the supplied CD.

Accessing the Camera by Device Search Software

- Step 1:** Double click on the program Device Search.exe.
- Step 2:** After its window appears, click on the <Device Search> button on the top. All the finding IP devices will be listed in the page.
- Step 3:** Find the camera in the list by its IP address and click on it. The default IP address of the camera is: **192.168.0.250**.
- Step 4:** The default IP address of the camera may not be in the same LAN as the IP address of the PC. If so, the IP address of the camera needs to be changed. Right click on the camera and click <Network Setup>. Meanwhile, record the MAC address of the camera, for future identification.
- Step 5:** The <Network Setup> page will come out. Select <DHCP> and click <Apply> down the page. The camera will be assigned with a new IP address.
- Step 6:** Click <OK> on the Note of setting change. Wait for one minute to re-search the camera.
- Step 7:** Click on the <Device Search> button to re-search all the devices. Find the camera in the list by its MAC address. Then double click or right click and select <Browse> to access the camera directly via a web browser.

Step 8: A prompt window requesting for default username and password will appear. Enter the default username and password shown below to login to the camera.

Login ID	Password
admin	admin



NOTE: ID and password are case sensitive.



NOTE: It is strongly advised that administrator's password be altered for the security concerns. Refer to the [Camera's Web UI Manual](#) in the supplied CD for further details.

Installing Viewer Software Online

For the initial access to the IP camera, a client program, Viewer, will be automatically installed to the PC when connecting to the IP camera.

If the web browser doesn't allow Viewer installation, please check the Internet security settings or ActiveX controls and plug-ins settings (refer to section [Setup Internet Security](#)) to continue the process.

The Information Bar (just below the URL bar) may come out and ask for permission to install the ActiveX Control for displaying video in browser. Right click on the Information Bar and select <Install ActiveX Control...> to allow the installation.

The download procedure of Viewer software is specified as follows.

Step 1: In the Viewer installation window, click on <Next> to start installation.

Step 2: The status bar will show the installation progress. After the installation is completed, click on <Finish> to exit the installation process.

Step 3: Click on <Finish> to close the Viewer installation page.

Once the Viewer is successfully installed, the Home page of the IP camera will be able to correctly display as the figure below.

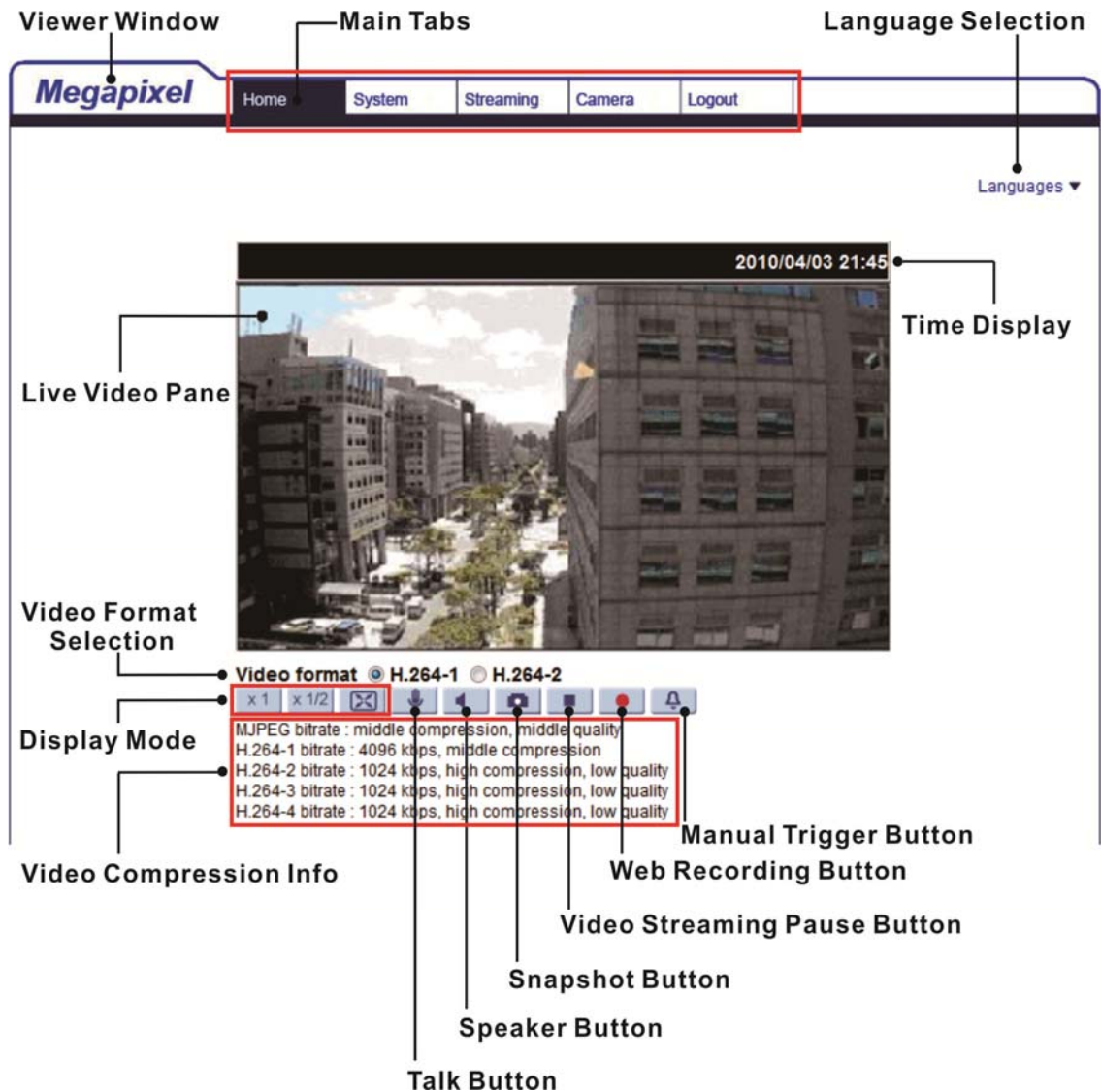

NOTE: For more details about the function buttons on the Home page, please refer to the Camera's Web UI Manual in the supplied CD.

5. Setup Video Resolution

Users can setup video resolution on Video Format page of the user-friendly browser-based configuration interface.

Video Format can be found under this path: **Streaming> Video Format**.

The screenshot shows the Megapixel web interface. The top navigation bar includes 'Home', 'System', 'Streaming', 'Camera', and 'Logout'. The 'Streaming' menu is highlighted with a red box. Below it, the 'Video Format' sub-menu is also highlighted with a red box. The main content area is titled 'Video Format' and contains the following sections:

- Video Resolution :** A dropdown menu set to 'H.264 + H.264 + H.264 + H.264'. Below it are four format options:
 - Format 1 : 1920 x 1080 (30 fps) with profile H-264-1
 - Format 2 : 1280 x 1024 (15 fps) with profile H-264-2
 - Format 3 : 1280 x 720 (30 fps) with profile H-264-3
 - Format 4 : 720 x 480 (30 fps) with profile H-264-4
- Note :** Image attachment by FTP or E-mail will be available only while MJPEG streaming is selected.
- Text Overlay Settings :** Includes checkboxes for 'Include date', 'Include time', and 'Include text string'. It also has dropdowns for 'Text color' (set to black) and 'Text background color' (set to transparent).
- Video Rotate Type :** A dropdown menu set to 'Normal video'.
- GOV Settings :** Includes input fields for GOV Length for each format: H.264-1 (60), H.264-2 (60), H.264-3 (30), and H.264-4 (30).
- H.264 Profile :** Includes dropdown menus for 'H.264-1' and 'H.264-2', both set to 'Main profile'.

The default values of video resolution are as below.

1.3M	H.264- 1280 x 720 (25/30 fps) + H.264- 1280 x 720 (25/30 fps)
2M	H.264- 1920 x 1080 (25 fps) + H.264- 720 x 480 (25 fps) H.264- 1920 x 1080 (30 fps) + H.264- 640 x 480 (30 fps)

For more details about the combinations of video resolution, please refer to the [Camera's Web UI Manual](#) in the supplied CD.

6. Configuration Files Export / Import

To export / import configuration files, users can access the Maintenance page on the user-friendly browser-based configuration interface.

The Maintenance setting can be found under this path: **System> Maintenance**.

Users can export configuration files to a specified location and retrieve data by uploading an existing configuration file to the IP camera.

Export

Users can save the system settings by exporting the configuration file (.bin) to a specified location for future use. Click on the <Export> button, and the popup File Download window will come out. Click on <Save> and specify a desired location for saving the configuration file.

Upload

To upload an existing configuration file to the camera, please first click on <Browse> to select the configuration file, and then click on the <Upload> button for uploading.

7. Tech Support Information

This chapter will introduce how to delete previously-installed Viewer in the PC and how to setup the Internet security.

7.1 Delete the Existing Viewer

For users who have installed the Viewer in the PC previously, please first remove the existing Viewer from the PC before accessing to the IP camera.

Deleting the Viewer

In the Windows <Start Menu>, activate <Control Panel>, and then double click on <Add or Remove Programs>. In the <Currently installed programs> list, select <Viewer> and click on the button <Remove> to uninstall the existing Viewer.

Deleting Temporary Internet Files

To improve browser performance, it is suggested to clean up all the files in the Temporary Internet Files. The procedure is as follows.

Step 1: Click on the <Tools> tab on the menu bar and select <Internet Options>.

Step 2: Click on the <Delete> button under <Browsing history> section. Then click on the <Delete Files> button under the <Temporary Internet files> section.

Step 3: A confirmation window will pop up. Click on <Yes> to start deleting the files.

7.2 Setup Internet Security

If ActiveX control installation is blocked, please either set Internet security level to default or change ActiveX controls and plug-ins settings.

Internet Security Level: Default

Step 1: Start the Internet Explorer (IE).

Step 2: Click on the <Tools> tab on the menu bar and select <Internet Options>.

Step 3: Click on the <Security> tab, and select <Internet> zone.

Step 4: Down the page, click on the <Default Level> button, and click on <OK> to confirm the setting. Close the browser window, and restart a new one later to access the IP camera.

ActiveX Controls and Plug-ins Settings

Step 1: Repeat **Step 1 to Step 3** of the previous section above.

Step 2: Down the page, click on the <Custom Level> button to change ActiveX controls and plug-ins settings. The Security Settings window will pop up.

Step 3: Under <ActiveX controls and plug-ins>, set **ALL** items (as listed below) to <Enable> or <Prompt>. Please note that the items vary by IE version.

ActiveX controls and plug-ins settings:

1. Binary and script behaviors.
2. Download signed ActiveX controls.
3. Download unsigned ActiveX controls.
4. Allow previously unused ActiveX controls to run without prompt.
5. Allow Scriptlets.
6. Automatic prompting for ActiveX controls.
7. Initialize and script ActiveX controls not marked as safe for scripting.
8. Run ActiveX controls and plug-ins.
9. Only allow approved domains to use ActiveX without prompt.
10. Script ActiveX controls marked safe for scripting*.
11. Display video and animation on a webpage that does not use external media player.

Step 4: Click on <OK> to accept the settings. A prompt window will appear for confirming the setting changes, click <Yes(Y)> and close the Security Settings window.

Step 5: Click on <OK> to close the Internet Options screen.

Step 6: Close the browser window, and restart a new one later to access the IP camera.