



### QUICK INSTALLATION GUIDE DN-16085

for more product details, please go to  
[www.digitus.info](http://www.digitus.info)

### Package Content

Before starting to set up your camera, please make sure items below in your box:

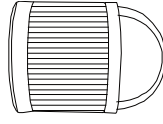

Camera



Quick guide

**Note: This camera requires a bracket to install. Please purchase separately.**

### Optional Bracket

Below is the bracket we have to use with this camera, and it is not supplied in the camera sales package. Please purchase separately.



DN-16056

#### The accessories:

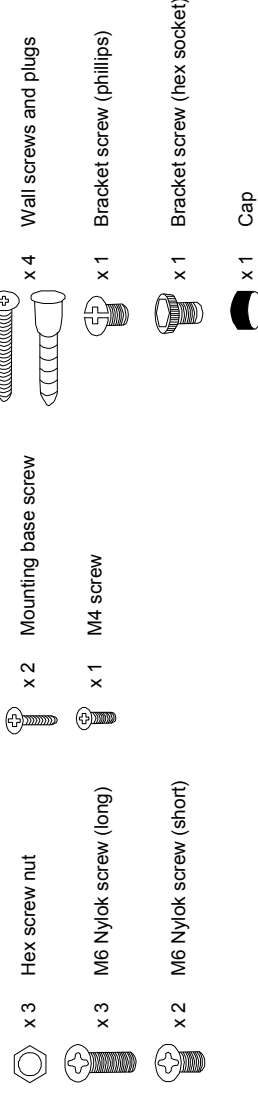

### Installation

Step1: Find the bracket and remove its upper cover, and install the bracket to the wall. Before attach the bracket to the wall, make sure how the cabling should go:

- For cabling along the wall, arrange the camera cable through one of the gaps.
- For cabling through the wall, remember to drill a hole big enough for the cable to go through.

Step2: Fasten the bracket to the wall.

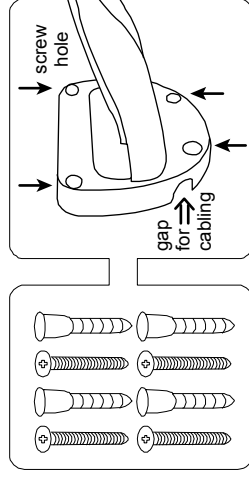

Step3: Insert the hex screw nuts to the mounting base, and turn it around.

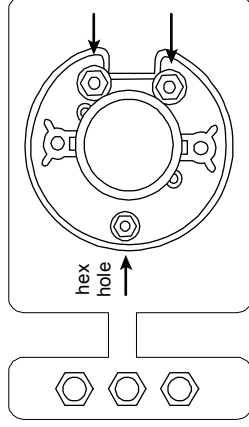

Step4: Find "→" on the camera. Then, place and fasten the mounting base to the camera as indicated below.

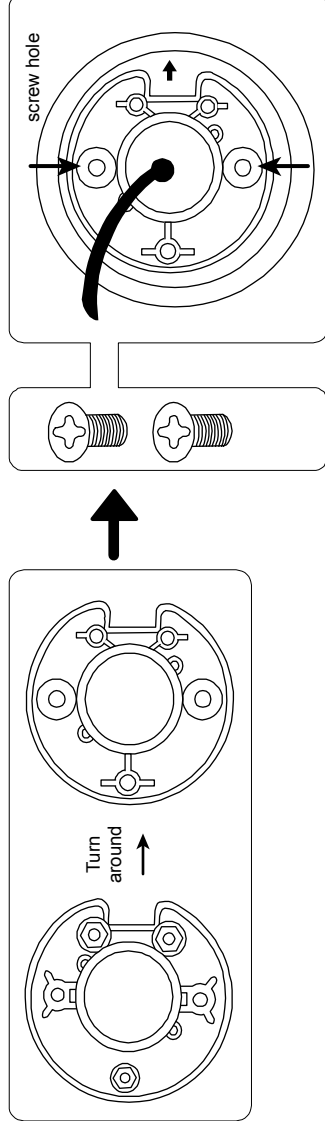

Step5: Attach and slightly fasten the camera to the bracket as indicated below. The camera is hooked.

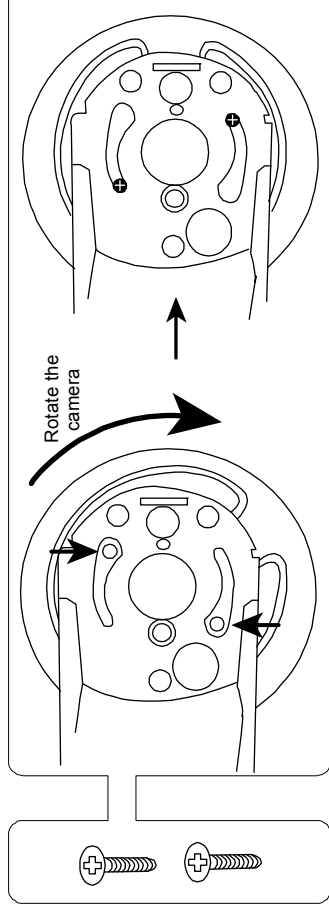

## Installation (Continued)

Step6: Slightly secure the camera and the bracket as indicated below.

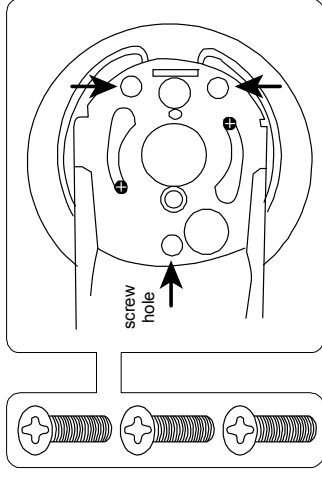

Step7: Fasten the camera to the bracket with the M4 screw as indicated below.

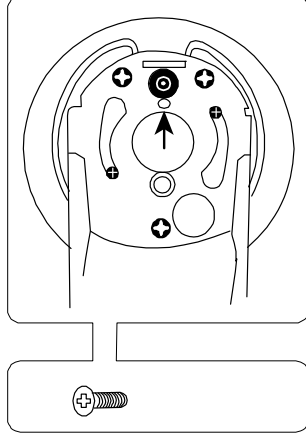

Step8: Replace the upper cover of the bracket back, and fasten it with a Philips screw or a hex socket screw, and put the cap on it to finish the installation.

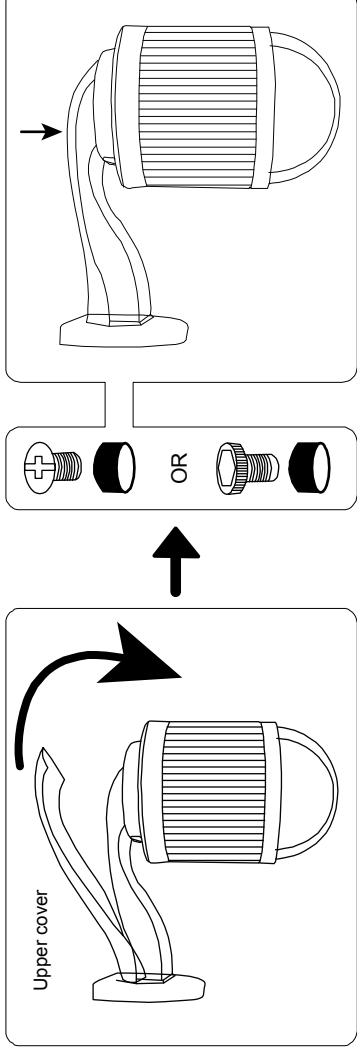

## Cable Overview

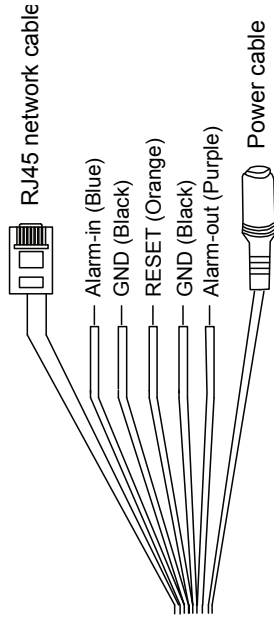

Color	Cable	Description
--	Power cable	DC12V power supply.
--	RJ45 network cable*	Connect it to a RJ45 cable.
Black & Brown	GND	Ground wire
Yellow	Alarm-in	Reserved for external alarm device connection
Pink	Alarm-out	Reserved for external alarm device connection
Red	RESET	Remove the insulating coating of wire, and twist it with a ground wire together to reset default camera

\* For PoE (IEEE802.3af) installation, make sure your network cable has the maximum cable resistance of 20  $\Omega$ , such as CAT.5e or CAT.6 cables, to conform to the standard of IEEE802.3af.

## Camera Configuration

Step1: Connect PC to the HUB connected to your camera(s) with RJ45 network cable.

Step2: Install the "IPScan.exe" from the CD on your computer and use this utility to find the IP address of the camera.

Step3: After searching, set your PC in the same network segment as the specific camera you want to access, such as "192.168.30.xxx" (xxx could be 0~255) in our example

Step4: Note down the IP address and port number of the camera you want to access, such as "192.168.30.1" and "88" in our example.

Step5: Open Internet Explorer on the PC, and enter the IP address and port number in the URL column to access the camera. The format is <http://ipaddress:portnum>, such as <http://192.168.30.1:88> in our example.

Step6: Enter the default user name (**admin**) and password (**admin**) to access the camera. Then, go to "Config" on the top right corner for more advanced configurations.

